

# UNI 321

## User's Guide



Ver 1.1  
Dec. 2018

# Contents

<b>Read Before Operating</b> .....	2
<b>General Information</b> .....	3
User Interface .....	3
Display .....	3
Normal Operation .....	3
<b>Normal Mode Operation</b> .....	4
Turning the Unit On.....	4
Warm-up Sequence .....	4
Remaining Time Display.....	4
Alarms .....	4
<b>Configuration mode</b> .....	5
Enter Config Mode.....	5
Zero (fresh air) calibration.....	5
Exit Config mode.....	5
<b>Maintenance</b> .....	6
Replacing the sensor filter .....	6
<b>Specifications</b> .....	8
<b>Sensor configurations</b> .....	9
<b>Alarm signal summary</b> .....	10
<b>Troubleshooting</b> .....	11

### Read Before Operating

This manual must be carefully read by all individuals who have or will have the responsibility of using, maintaining or servicing this product. The product will perform as designed only if it is used, maintained and serviced in accordance with the manufacturer's instructions.

### **Warning**

- Never operate the monitor when the cover is removed.
- Remove the monitor cover and battery only in an area known to be non-hazardous.
- Use only mPower's lithium battery part number 1.17.02.0002 (3.6V, 2700mAh, AA size) or part No. ER14505 cell manufactured by EVE Energy Co., LTD.
- This instrument has not been tested in an explosive gas/air atmosphere having an oxygen concentration greater than 21%.
- Substitution of components will impair suitability for intrinsic safety.
- Substitution of components will void warranty.
- It is recommended to bump test with a known concentration gas to confirm the instrument is functioning properly before use.
- Before use, ensure that the ESD film on the display is not damaged or peeling.

### **Avertissement**

- N'utilisez jamais le moniteur lorsque le couvercle est enlevé.
- Retirer le couvercle du moniteur et la batterie uniquement dans une zone connue comme non dangereuse.
- Utilisez uniquement la batterie au lithium de mPower, pièce No. 1.17.02.0002 (3.6V, 2700mAh, taille AA) ou celle de EVE Énergie Cie., Lté, pièce No. ER14505.
- Cet instrument n'a pas été testé dans une atmosphère explosive gaz / air ayant une concentration en oxygène supérieure à 21%.
- La substitution de composants compromettra l'aptitude à la sécurité intrinsèque.
- La substitution des composants annulera la garantie.
- Il est recommandé de tester avec un gaz de concentration connu pour confirmer que l'instrument fonctionne correctement avant de l'utiliser.
- Avant de l'utiliser, assurez-vous que le film ESD sur l'écran n'est pas endommagé ou épluché.

### Proper Product Disposal at End of Life



The Waste Electrical and Electronic Equipment (WEEE) directive (2002/96/EC) is intended to promote recycling of electrical and electronic equipment and their components at end of life. This symbol (crossed-out wheeled bin) indicates separate collection of waste electrical and electronic equipment in the EU countries. This product may contain one or more nickel-metal hydride (NiMH), lithium-ion, or alkaline batteries. Specific battery information is given in this user guide. Batteries must be recycled or disposed of properly. At the end of its life, this product must undergo separate collection and recycling from general or household waste. Please use the return and collection system available in your country for the disposal of this product.

## General Information

The UNI 321 is a disposable or maintenance-free version of the UNI single gas detector. It detects H<sub>2</sub>S, CO or O<sub>2</sub> in a selection of models for an operation life of either 12 months (MP101), 24 months (MP102) or 36 months (MP103). The detector has a large LCD providing maximum readability in the field. Six bright red LEDs allow for quick alarm notification. Constructed of strong and durable material, the UNI is designed to be comfortable, yet drop-resistant.



## User Interface

1. Buzzer
2. LED alarm window
3. LCD
4. Left key (Confirm/Number increasing key)
5. Right key (Power/ Cursor moving key)
6. Alligator clip
7. Sensor

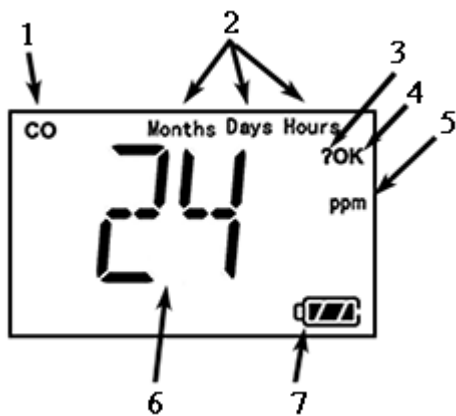

## Display

1. Gas name, includes: CO, H<sub>2</sub>S, O<sub>2</sub>,
2. Remaining time unit: Months, Days, Hours
3. Question mark
4. Unit status indicator "OK"
5. Gas concentration unit, for alarm setting display
6. Remaining operating time (Months/Days/Hours)
7. Battery status

## Normal Operation



Normal operation is limited to the following functions

- Displaying the remaining operating time (the unit cannot be turned off)
- Displaying (and logging) the Alarm Level if this concentration of gas is exceeded
- Entering Configuration Mode to perform a fresh air zero calibration
- Replacing the sensor filter if used in especially highly dusty or moist environments







Full bump test or calibration, setting alarm limits, and other functions can only be performed through use of the CaliCase System MP300T1 by a qualified service technician.

## Normal Mode Operation

### Turning the Unit On

Press and hold the Right Key  for 3 seconds, until the LCD displays , the buzzer beeps, and the green LED flashes.

### Warm-up Sequence

- After powering on, the unit enters a warm up and self-test sequence, and shows the firmware version as:  
- If the sensor is not installed or cannot be identified by the instrument, the screen flashes between  and .
- Lastly, the High Alarm limit  and Low Alarm limit  are shown.



### Remaining Time Display

After the start-up sequence, the unit enters normal mode and displays the remaining operating time.  Once the unit is running, it cannot be turned off manually and it stays on until the battery loses power.

### Alarms

If the gas concentration exceeds an alarm limit, the display shows the alarm value being exceeded  and gives audio, visual and vibration alarms according to the table at the end of this manual (see **Alarm signal summary**). Once the gas concentration is no longer in an alarm condition, the unit reverts back to the time display, but logs the alarm event in memory.



#### Calibration Fail Alarm (For Service Use Only)

If the instrument fails calibration, it will alternately display  and the remaining run time , once per second. The user can perform a manual Zero Calibration (see below) on the instrument alone, but a full Zero/Span calibration requires the CaliCase System MP300T1.

#### Bump Fail Alarm (For Service Use Only)

If the instrument fails a Bump test using the CaliCase System MP300T1, it will alternately

## UNI 321 User's Guide

display  and the remaining run time  once per second.



### Bump Due Alarm (For Service Use Only)

If the Bump Due setting is enabled and the due date has passed, the question mark will flash once per second while the display continues to show the remaining run time .

## Configuration mode





In Config mode, the user can do a zero (fresh air) calibration only. In general, use the Left Key to increase the number or confirm, use the Right Key to move the cursor or move to the next programming item. Detailed configuration settings can be performed using the mPower Suite software through the CaliCase System MP300T1 (see CaliCase manual).

### Enter Config Mode

Press and hold the Left Key and the Right Key simultaneously for 3 seconds. The unit prompts for a password\* by displaying  and , with one digit flashing. To input the password, use the Left Key to increase the number, and the Right Key to move the cursor. Once all four digits are entered, the cursor will move to “OK”, use the Left Key to finish password input and enter the Config mode. To correct a digit input mistake, use the Right Key to move the cursor between the four digits and “OK” mark, to change the input.

\*The UNI 321 preset password is 0000

### Zero (fresh air) calibration

Zero calibration is to set the base line for the sensor. It is done in fresh air or other source known to be free of detectable gas (For an O<sub>2</sub> unit, “zeroing” sets the value to 20.9%, so air must be used). When the LCD displays , press the Left Key to start zero calibration. The unit will start a 15 second count-down, and then display the calibration result as either pass  or fail . The user can abort the zero calibration during the 15 seconds count-down by pressing the Right Key, after which  is displayed.

### Exit Config mode

After zero calibration is either skipped or completed, the unit displays . Press the Left Key to exit back to normal mode.

## Maintenance

NOTE: The UNI 321 is designed as a disposable instrument and does not need maintenance under normal circumstances. However, in highly dusty or wet environments, it may be necessary to replace the sensor filter as described below.



Maintenance should be performed only by a qualified person who has proper training and fully understands the contents of the manual.

### Replacing the sensor filter

The filter may need replacement under special circumstances such as use high-dust or condensing environments. Sheets of 5 “peel-and-stick” filters are available for this purpose:

- 1) Turn off the UNI 321 and place it face down on a soft surface.
- 2) Use a T10 Torx screwdriver to loosen (counterclockwise) each of the four screws.
- 3) Remove the top cover after carefully unplugging the buzzer connector.
- 4) Peel a filter from the sheet and center it over the sensor. Gently press down.
- 5) Re-connect in the buzzer connector and re-install the top cover.
- 6) Re-install the screws in the back cover. Be careful to not overtighten the screws.

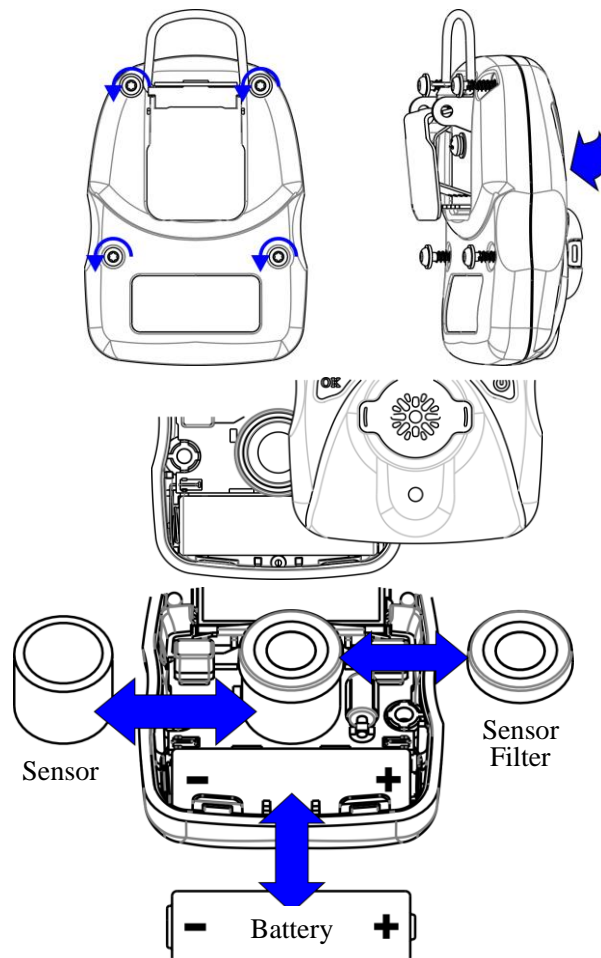



## Caution

- **Change battery only in area known to be non-hazardous.**
- **Use only mPower battery, PN: 1.17.02.0002 or part No. ER14505 cell manufactured by EVE Energy Co., LTD.**



## Attention

- **Changez la batterie uniquement dans une zone connue pour être non dangereuse.**
- **Utilisez uniquement la batterie au lithium de mPower, pièce No. 1.17.02.0002 (3.6V, 2700 mAH, taille AA) ou celle de EVE Énergie Cie., Lté, pièce No. ER14505.**

## Year of manufacture

The fifth and sixth digits in the serial number of the instrument indicate the year of manufacture, i.e., 00-99 indicate years 2000 to 2099



## UNI 321 User's Guide

# Specifications

Size	3.46 x 2.44 x 1.3 in. (88 x 62 x 33mm)
Weight	4.4 oz. (125 g)
Temperature	-4°F to 122°F (-20°C to 50°C)
Humidity	5 to 95% relative humidity (non-condensing)
Alarm type	High alarm, low alarm adjustable Over range alarm, battery low alarm
Alarm signal	Audible: 90 dB @ 30 cm Visual: Bright red LED Sense: Built in vibrator
Calibration	2 point calibration, zero and span, power on zero (user-selectable). *The UNI detectors can easily be bump tested and calibrated with the CaliCase System.
Event log	Up to 50 alarm events *The last 50 alarm events can be shown using mPower Suite software only.
Response time (T90)	20 seconds
IP rating	IP67
EMI/RFI	Compliant with EMC 2004/108/EC
Certifications	Intrinsic Safety: UL/cUL: Class I, Group A, B, C, D Class II, Group E, F, G Class III, Hazardous Locations T4, $-20^{\circ} \text{C} \leq T_{\text{amb}} \leq +50^{\circ} \text{C}$
Battery & Life	Replaceable AA size Lithium battery, Up to 3 years if used within specifications
Operation Life	1 year for MP101 2 years for MP102 3 years for MP103

\*\*mPower Suite (MP600) is a PC software used to show and set more configuration parameters of UNI 321 instrument through the CaliCase System MP300T1.



CaliCase

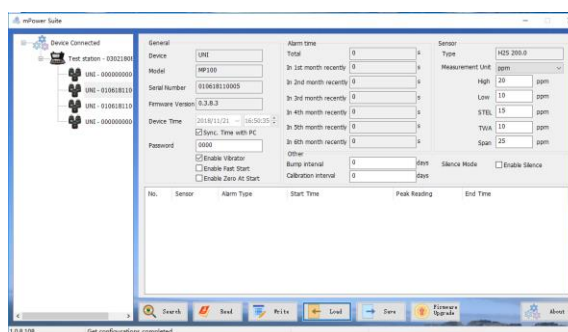

MP600 Software

## Sensor configurations

Sensor	Range (ppm)	Resolution (ppm)	Span (ppm)	Low (ppm)	High (ppm)	Panel Ring	T90(s)
CO	0-500	1	50	35	200	Red	20
H <sub>2</sub> S	0-100	0.1	25	10	20	Light Blue	20





Sensor	Range (%)	Resolution (%)	Span (%)	Low (%)	High (%)	Panel Ring	T90(s)
O <sub>2</sub>	0 - 30	0.1	0.0	19.5	23.5	Dark Blue	20





### Caution

**Use only mPower sensors.**

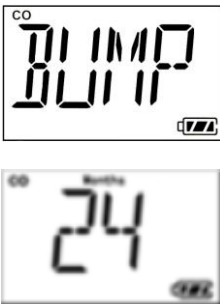
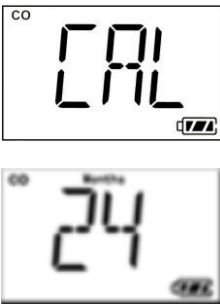
## Alarm signal summary

LCD Display	Reason/Alarm Signals
	<p><b>Low alarm:</b></p> <ul style="list-style-type: none"> <li>Buzzer 2 beeps per second</li> <li>LED 2 flashes per second</li> <li>1 vibration per second</li> <li>“LOW” 2 flashes per second</li> </ul>
	<p><b>High alarm:</b></p> <ul style="list-style-type: none"> <li>Buzzer 3 beeps per second</li> <li>LED 3 flashes per second</li> <li>1 vibration per second</li> <li>“HIGH” 2 flashes per second</li> </ul>
	<p><b>Over-range:</b></p> <ul style="list-style-type: none"> <li>Buzzer 3 beeps per second</li> <li>LED 3 flashes per second</li> <li>1 vibration per second</li> <li>“OVER” and “500” 1 flash per second</li> </ul>
	<p><b>Bump Due alarm:</b></p> <ul style="list-style-type: none"> <li>? 2 flash per second</li> </ul>
	<p><b>Bump Fail alarm:</b></p> <ul style="list-style-type: none"> <li>Buzzer 1 beep per minute</li> <li>LED 1 flash per minute</li> <li>1 vibration per minute</li> <li>“Bump” and “Remain Time” alternate display per second</li> </ul>
	<p><b>Calibration Fail alarm:</b></p> <ul style="list-style-type: none"> <li>Buzzer 1 beep per minute</li> <li>LED 1 flash per minute</li> <li>1 vibration per minute</li> <li>“CAL” and “Remain Time” display alternately once per second</li> </ul>

## UNI 321 User's Guide

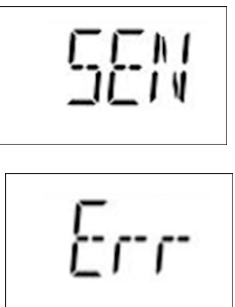
	<p><b>Battery Low alarm:</b></p> <ul style="list-style-type: none"> <li> Battery Empty prompt</li> <li>Buzzer 1 beep per minute</li> <li>LED 1 flash per minute</li> <li>1 vibration per minute</li> </ul>
	<p><b>Battery fail alarm:</b></p> <ul style="list-style-type: none"> <li>Buzzer 1 beep per second</li> <li>LED 1 flash per second</li> <li>“bAT LoW”1 flash per second</li> </ul>
	<p><b>Sensor error:</b></p> <ul style="list-style-type: none"> <li>Buzzer 1 beep per second</li> <li>LED 1 flash per second</li> <li>“SEN Err”1 flash per second</li> </ul>

## Troubleshooting

Problem	Possible reason	Solution
Cannot turn on unit	Battery not installed	Install battery
	Depleted or defective battery	Replace battery
Buzzer, LED, or vibration alarm inoperative	Bad buzzer, LEDs, or vibration alarm.	Call authorized service center
	Blocked alarm port	Unblock alarm port

## UNI 321 User's Guide



### **mPower Electronics, Inc.**

3046 Scott Boulevard, Santa Clara, CA 95054

Phone: (408)320-1266

Fax: (669)342-7077

[info@mpowerinc.com](mailto:info@mpowerinc.com)

[www.mpowerinc.com](http://www.mpowerinc.com)