

MUNI

Multi-Gas Detectors

MP420

User's Guide



Contents

1. General Information	4
1.1 Main Features	4
2. Battery	5
2.1 Battery Charging	5
2.2 Battery Status	5
2.3 Battery Replacement	5
3. User Interface	6
3.1 Displays and Keys	6
3.2 Alarm Overview	8
4. Basic Operation.....	9
4.1 Turning On	9
4.2 Turning Off	9
4.3 Active Sensor Displays.....	9
4.4 Alarm Testing and Backlight	9
4.5 Main User Menu	10
5. Configuration Mode.....	11
5.1 Entering Configuration Mode	11
5.2 Exiting Configuration Mode	11
5.3 Navigating Configuration Mode to Edit Parameters	11
5.4 Calibration and Bump Testing.....	12
5.5 Sensor Enable/Disable	16
5.6 Sensor Alarm Settings	16
5.7 Monitor Set-up.....	16
6. PC Communication.....	17
6.1 Connecting and Configuring	17
6.2 Event Log Retrieval and Calibration Certificates.....	20
7. MuniDock Operation	21
7.1 MuniDock Cal/Bump Procedures	21
7.2 MuniDock Data Download and Calibration Certificates	21
8. Maintenance.....	22
8.1 External Filter.....	22
8.2 Replacing Internal Filter, Sensors, LCD or Battery.....	22
9. Troubleshooting.....	23
10. Technical Specifications	24
Technical Support and mPower Contacts.....	25

Read Before Operating

This manual must be carefully read by all individuals who have or will have the responsibility of using, maintaining or servicing this product. The product will perform as designed only if it is used, maintained and serviced in accordance with the manufacturer's instructions. The user should understand how to set the correct parameters and interpret the obtained results.

CAUTION !

- REMOVE MONITOR COVER ONLY IN AREA KNOWN TO BE NON-HAZARDOUS.
- RECHARGE BATTERY ONLY IN AN AREA KNOWN TO BE NON- HAZARDOUS.
- USE ONLY mPOWER'S RECHARGEABLE LITHIUM BATTERY P/N M020-3001-000.
- USE OF NON-mPOWER COMPONENTS WILL VOID THE WARRANTY AND CAN COMPROMISE THE SAFE PERFORMANCE OF THIS PRODUCT
- SUBSTITUTION OF COMPONENTS MAY IMPACT INTRINSIC SAFETY.

CAUTION: HIGH OFF-SCALE READINGS MAY INDICATE AN EXPLOSIVE CONCENTRATION. ANY RAPID UP-SCALE READING FOLLOWED BY A DECLINING OR ERRATIC READING MAY INDICATE A GAS CONCENTRATION BEYOND UPPER SCALE LIMIT WHICH MAY BE HAZARDOUS.

ATTENTION: DES LECTURES SUPÉRIEURES A L'ÉCHELLE PEUVENT INDIQUER DES CONCENTRATIONS EXPLOSIVES. TOUTE LECTURE RAPIDE ET POSITIVE, SUIVIE D'UNE BAISSSE SUBITE AU ERRATIQUE DE LA VALEUR, PEUT INDIQUER UNE CONCENTRATION DE GAZ HORS GAMME DE DÉTECTION QUI PEUT ÊTRE DANGEREUSE.

WARNINGS !

ONLY THE COMBUSTIBLE GAS DETECTION PORTION OF THIS INSTRUMENT HAS BEEN ASSESSED FOR PERFORMANCE.

UNIQUEMENT, LA PORTION POUR DÉTECTOR LES GAZ COMBUSTIBLES DE CET INSTRUMENT A ÉTÉ ÉVALUÉE.

CAUTION: BEFORE EACH DAY'S USE, THE SENSITIVITY OF THE COMBUSTIBLE GAS SENSOR MUST BE TESTED ON A KNOWN CONCENTRATION OF METHANE GAS EQUIVALENT TO 20 TO 50% OF FULLSCALE CONCENTRATION. ACCURACY MUST BE WITHIN 0 AND +20% OF ACTUAL. ACCURACY MAY BE CORRECTED BY A CALIBRATION PROCEDURE.

ATTENTION: AVANT CHAQUE UTILISATION JOURNALIERE VERIFIER LA SENSIBILITE AVEC UNE CONCENTRATION CONNUE DE METHANE EQUIVALENTE A 20-50% DE LA PLEINE ECHELLE. LA PRECISION DOIT ETRE COMPRISE ENTRE 0-20% DE LA VALEUR VRAIE ET PEUT ETRE CORRIGEE PARUNE PROCEDURE D'ETALONNAGE.

⚠ WARNINGS !

This device complies with part 15 of the FCC Rules. Operation is subject to the following two conditions: (1) This device may not cause harmful interference, and (2) this device must accept any interference received, including interference that may cause undesired operation.

CAUTION: Changes or modifications to this unit not expressly approved by the party responsible for compliance could void the user's authority to operate the equipment.

NOTE: This equipment has been tested and found to comply with the limits for a Class B digital device, pursuant to part 15 of the FCC Rules. These limits are designed to provide reasonable protection against harmful interference in a residential installation. This equipment generates, uses and can radiate radio frequency energy and, if not installed and used in accordance with the instructions, may cause harmful interference to radio communications. However, there is no guarantee that interference will not occur in a particular installation. If this equipment does cause harmful interference to radio or television reception, which can be determined by turning the equipment off and on, the user is encouraged to try to correct the interference by one or more of the following measures:

- Reorient or relocate the receiving antenna.
- Increase the separation between the equipment and receiver.
- Connect the equipment into an outlet on a circuit different from that to which the receiver is connected.
- Consult the dealer or an experienced radio/TV technician for help.

Special Conditions for Safe Use

- The MUNI multi-gas detector must be calibrated if it does not pass a bump test, when a new sensor has been installed, or at least once every 180 days, depending on use and sensor exposure to poisons and contaminants.
- No precautions against electrostatic discharge are necessary for portable equipment that has an enclosure made of plastic, metal or a combination of the two, except where a significant static-generating mechanism has been identified. Activities such as placing the item on a belt, operating a keypad or cleaning with a damp cloth, do not present a significant electrostatic risk. However, where a static-generating mechanism is identified, such as repeated brushing against clothing, then suitable precautions shall be taken, e.g., the use of anti-static footwear.

Note: Users are recommended to refer to ISA -RP12.13, Part II-1987 for general information on installation, operation, and maintenance of combustible gas detection instruments.

Proper Product Disposal at the End of Life



The Waste Electrical and Electronic Equipment (WEEE) directive (2002/96/EC) is intended to promote recycling of electrical and electronic equipment and their components at end of life. This symbol (crossed-out wheeled bin) indicates separate collection of waste electrical and electronic equipment in the EU countries. This product may contain one or more Nickel-metal hydride (NiMH), Lithium-ion, or Alkaline batteries. Specific battery information is given in this user guide. Batteries must be recycled or disposed of properly. At the end of its life, this product must undergo separate collection and recycling from general or household waste. Please use the return and collection system available in your country for the disposal of this product.

1. General Information

The MUNI MP420 is a compact and lightweight 4-gas detector for worker safety at hazardous locations, with four standard sensors for oxygen (O₂), combustibles (LEL), carbon monoxide (CO) and hydrogen sulfide (H₂S). Alternative sensors are lead-free oxygen (O₂), low power infrared methane (CH₄), sulfur dioxide (SO₂), and hydrogen cyanide (HCN). The detector is packaged in a robust housing with no moving parts. Its battery power offers 2 work shifts of run time (24 hours) for a standard 4-gas detector, and extended duration when using a low-power infrared sensor. The simple, 2-button operation results in ultimate ease of use and significantly reduced time spent training the user.

1.1 Main Features

- Various models for basic confined space entry (CSE) compliance, plus SO₂ and HCN sensors.
- Diffusion sampling
- Compact, robust, lightweight & wearable
- Auto backlit LCD with large numeric digits
- Easy-to-navigate menu with two buttons
- Battery operation 24 hours with pellistor LEL sensor or extended time with low-power infrared LEL sensor
- Two-color status indicators on regular self-diagnosis of sensor, battery and circuitry
- Wide angle LED alarms
- 1000 Events log
- Combination charge adapter / micro-USB PC interface cable
- IP-68 weather ingress rating
- Replaceable sensors & battery
- Optional BLE wireless connectivity
- Optional MuniDock for convenient bump & calibration
- Durable double-shot outer case

NOTE

Due to continuous improvement of our products, this manual may not reflect all of the latest updates in software, firmware and hardware for the instrument received.

2. Battery

Fully charge the MUNI battery upon receiving the instrument and before each day's use.

⚠ WARNING

To reduce the risk of ignition of hazardous atmospheres, recharge only in an area known to be non-hazardous!

2.1 Battery Charging



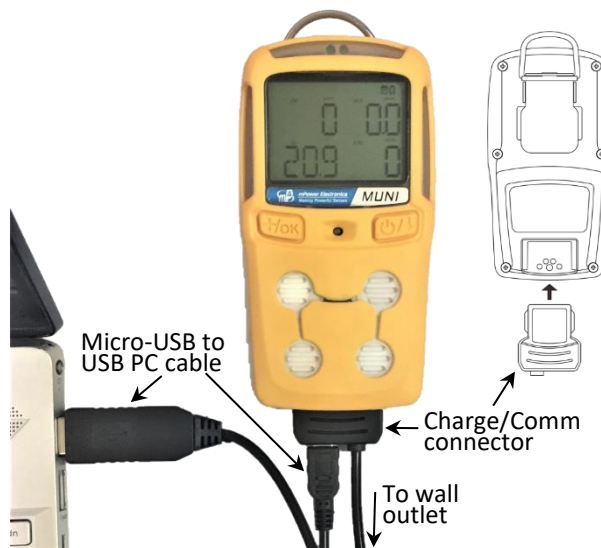

Slide the charge/comm connector into the bottom of the MUNI and the AC adapter to the wall power outlet. Alternatively, charge on a PC using the Micro-USB to USB cable. During active charging, the battery icon cycles from empty to full if the unit is on. If the unit is turned off, a red LED indicates charging, which switches to green when completely charged. Full charging from an empty battery takes about 4 hours using the AC adapter. Connecting to a PC alone may not fully charge the battery. It is safe to use both the AC adapter and the PC cable simultaneously.



NOTE: Any locally-obtained USB A to Micro B USB cable works for charging on a PC, but does not work for communication with mPower Suite configuration and data transfer software. The mPower USB cable P/N M011-3003-000 is required for a PC to recognize the instrument and communicate with mPower Suite.

2.2 Battery Status

The small battery icon in the upper right corner of the display shows the battery charge level, and alerts of any charging problem.

			 blink
Full charge	Partial Charge	Low Charge	Battery Alarm

When the battery's charge falls below a preset voltage, the instrument warns by beeping once and flashing once every minute. The instrument automatically powers down within 10 minutes, after which the battery must be recharged. When a low-battery alarm occurs, we recommended promptly switching instruments to a fully charged MUNI, and/or charging the battery in a non-hazardous location.

2.3 Battery Replacement

The MUNI Lithium-ion battery pack is soldered to the circuit board and is free of maintenance. In case of a battery failure or end of operating life, contact the mPower Service Department or an authorized service center for a battery replacement.

3. User Interface

The MUNI user interface consists of two keys, four sensor sockets, one large Liquid Crystal Display (LCD), six alarm LEDs, one buzzer, and one vibration alarm.

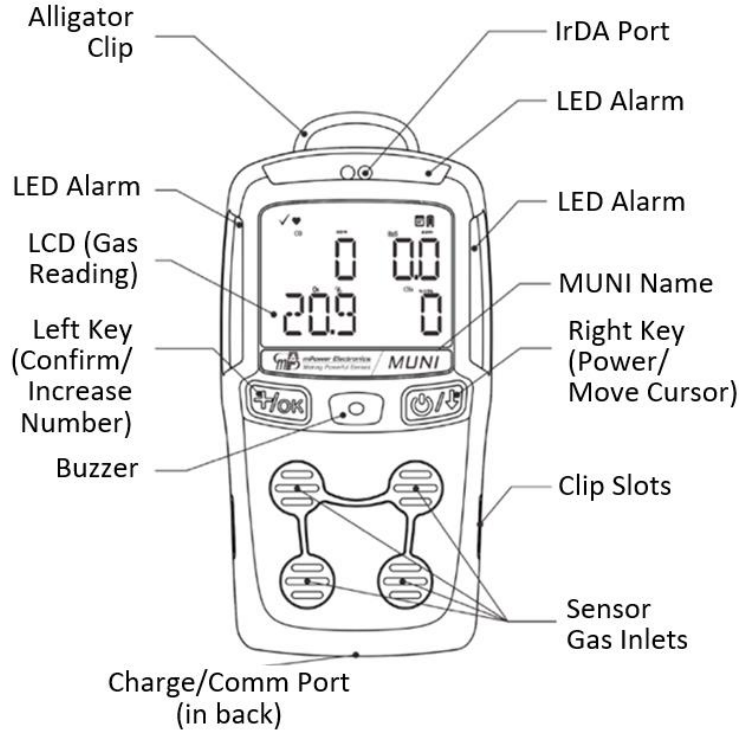





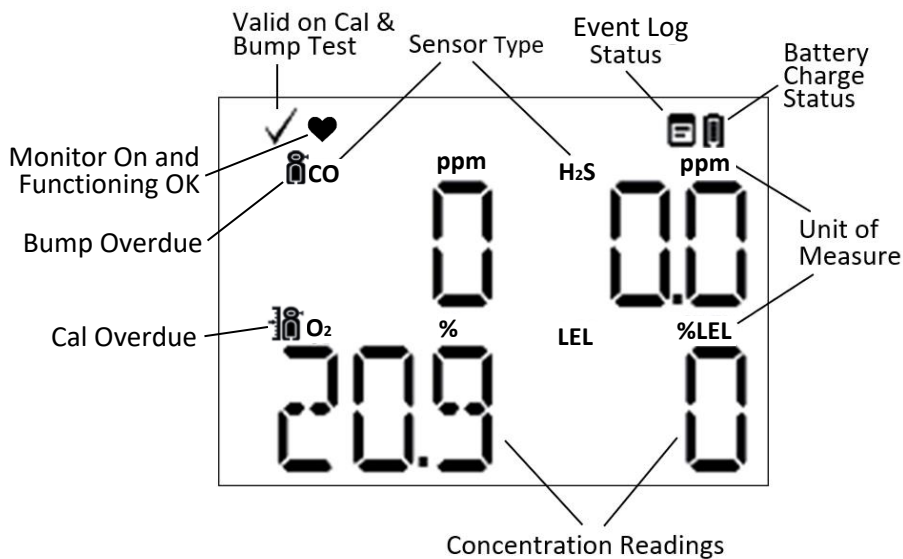

3.1 Displays and Keys

The LCD provides visual information that includes real-time gas readings, sensor types, event log status, battery status, wireless status, and others.



3.1.1 Status Indicator Icons

Along the top of most screens are status icons that indicate whether a function is operating and/or its strength or level.

Icon	Function
	Bluetooth wireless communication enabled
	Heart flashing, along with green LED flashing, indicates the unit is on and functioning
	Event logging enabled (cannot turn off)
	Battery voltage status
	All sensors have been bump tested and calibrated; no sensor is overdue for a bump test or calibration according to the intervals configured on the instrument.
	Calibration overdue
	Bump overdue

3.1.2 Keys and Interface

The MUNI has two keys:



Left [+ / OK] Key
Confirm Operation/Increase Number



Right [Power / Down Arrow] Key
Power On-Off/Move Cursor

These two keys are marked as [+ / OK] to Confirm Operations or Increase Number and [Power / Down Arrow] to Power On-Off / Move Cursor.

In addition to the functions described above, pressing the Left [+ / OK] key from the main display can be used to manually activate the LCD backlight when it is off, and to manually test the LED, audio and vibration alarms for proper function.

3.2 Alarm Overview

The MUNI provides an unmistakable four-way alarm notification that includes an audible buzzer, bright LED lights, vibration, and alarm notification on the display. The alarm thresholds can be programmed and the sensors selectively turned on or off.

During each measurement period, the gas concentration is compared with the programmed alarm limits for Low, High, TWA and STEL alarms. If the concentration exceeds (or goes below, in the case of oxygen) any of the preset limits, the alarms are activated immediately to warn both the MUNI user of the alarm condition. In addition, the MUNI alarms when the battery voltage is low and in other fault conditions.

Alarm Types and Priority

	Alarm Type	Red LED	Buzzer	Vibrator
Priority (Highest to Lowest) 	Max Sensor Alarm (Sensor response limit)	3 Flashes/sec	3 Beeps/sec	1 Vibration/sec
	Sensor Fail Alarm	3 Flashes/sec	3 Beeps/sec	1 Vibration/sec
	Over-range Alarm (Firmware display limit)	3 Flashes/sec	3 Beeps/sec	1 Vibration/sec
	High Gas Alarm	3 Flashes/sec	3 Beeps/sec	1 Vibration/sec
	Low Gas Alarm	2 Flashes/sec	2 Beeps/sec	1 Vibration/sec
	Negative Drift	1 Flash/sec	1 Beep/sec	1 Vibration/sec
	STEL Alarm	1 Flash/sec	1 Beep/sec	1 Vibration/sec
	TWA Alarm	1 Flash/sec	1 Beep/sec	1 Vibration/sec
	Calibration Fail	1 Flash/sec	1 Beep/sec	1 Vibration/sec
	Bump Test Fail	1 Flash/sec	1 Beep/sec	1 Vibration/sec
	Battery Low	1 Flash/min	1 Beep/min	1 Vibration/min

4. Basic Operation

4.1 Turning On

Press and hold the [⏻/↓] Key for 3 seconds, until the buzzer beeps and the red LED flashes. As the unit powers on, it will go through a self-test and warm-up before the MUNI's main reading screen appears and it is ready for use. If a sensor is not warmed up, it will display "--" until it is ready (usually 30 seconds or less).

CAUTION: The alarm is loud. During startup, one can mute most of the sound by temporarily holding a finger over the buzzer opening. Do not put tape over the buzzer opening as it continuously mutes, causing a serious safety concern.

4.2 Turning Off

In normal reading mode, press and hold the [⏻/↓] key for a 5-second count down until the unit displays 'UNIT OFF'.

4.3 Active Sensor Displays

When one or more sensors is either not installed or turned off, the display shows only the installed, active sensors.

4.4 Alarm Testing and Backlight

Under normal operation mode and non-alarm conditions, the audible (buzzer) alarm, vibration alarm, LED, and backlight can be tested at any time by pressing Left [+ / OK] once. Holding down the [+ / OK] key for more than 3 seconds repeats the alarm test for as long as the Left [+ / OK] key is held down.

The backlight can be turned on for one minute, to aid visibility in dark conditions, by pressing Left [+ / OK] once or by pressing Right [⏻/↓] and cycling through the Main User Menu (these methods apply only if the backlight is in Manual Mode, but not in Automatic Mode; see PC Communication, Section 6.1)

WARNING!

If any of the alarms do not respond to this test, check the Alarm Settings using mPower Suite to see if the alarms have been turned off. If any of the alarms is enabled but not functional, do not use the instrument. Contact an mPower service center for technical support.

4.5 Main User Menu

Repeatedly pressing the Right [ϕ/↓] key gives quick access to view various parameters. The Peak, Minimum, STEL and TWA for each sensor since turn-on are displayed, with the option to clear and re-start Peak or Minimum. The date and time screens are self-explanatory. If the MUNI is fitted with an LEL sensor, the corresponding Calibration Gas and Measurement Gas (and its Correction Factor) are displayed (these can be changed in mPower Suite). The last display before returning to Real time readings is “Comm Mode?”. Pressing Left [+ /OK] stops the readings, and waits for communication with a PC using mPower Suite to transfer data or update the instrument configuration (see Section 6).

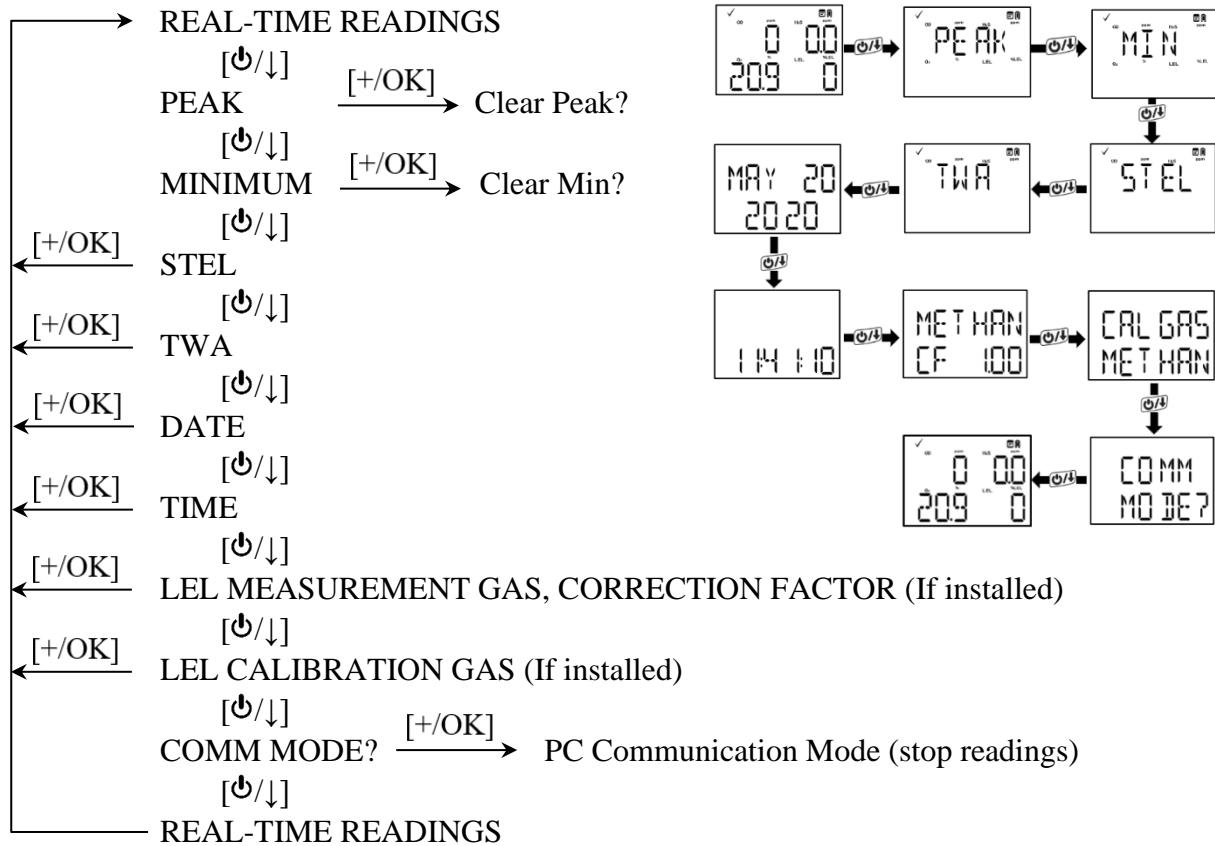

5. Configuration Mode

The Configuration Mode (Config Mode) is used to adjust the MUNI's operation settings and to calibrate sensors.

5.1 Entering Configuration Mode

Press and hold both the [+ / OK] and [⏏ / ↓] keys simultaneously for 3 seconds until the password screen appears (PWD_ _ _ _ ?). The default password is '0000' and can be changed using mPower Suite software. The password is needed only the first time Configuration Mode is entered after power is turned on.

- Move the cursor to the desired digit using the Right [⏏ / ↓] key.
- Increase the number from 0 through 9 by pressing Left [+ / OK].
- After entering all four digits, press [⏏ / ↓] again to move to the ? and press [+ / OK] to register the password and enter Configuration Mode.

If the password is not correct, the message 'PWD ERROR RETRY?' Press Left [+ / OK] to retry or Right [⏏ / ↓] to return to normal reading mode. If a wrong digit is entered, use the [⏏ / ↓] key to move the cursor among four digits and press [+ / OK] to change the input.

5.2 Exiting Configuration Mode

To exit, scroll through the main Configuration Mode Menu using the Right [⏏ / ↓] key until EXIT? is displayed and press [+ / OK]. Or simply wait, and the unit will return to normal operating mode automatically if no buttons are pressed for one minute.

5.3 Navigating Configuration Mode to Edit Parameters

After entering Configuration Mode, the CAL? menu is displayed first. Press Right [⏏ / ↓] to step through the menus and Left [+ / OK] to enter a menu. Once inside a sub-menu, press [⏏ / ↓] to move the cursor and [+ / OK] to edit and save parameters, as exemplified above for passwords. To exit a sub-menu, scroll through the entire list until EXIT? is shown, and then press Left [+ / OK].

Configuration Mode Menus and Sub-menus



CAL? (Calibration)	SENSOR ONOFF? (Enable/Disable)	SENSOR ALARM? (Set Alarm Limits)	MNT SETUP? (Monitor Set-up)	EXIT?
AIR CAL?	SAVE?	HIGH ALARM?	DATE?	
SINGLE SPAN?		LOW ALARM?	TIME?	
MULTI SPAN?		STEL ALARM?	EXIT?	
SET SPAN?		TWA ALARM?		
SINGLE BUMP?		EXIT?		
MULTI BUMP?				
CAL INTVL?				
BUMP INTVL?				
EXIT?				

5.4 Calibration and Bump Testing

Use this menu to perform zero or span calibration for one or more sensors, bump test the sensors and alarms for function, and change the span gas concentration.

The MUNI should be calibrated on the first day of use and at regular intervals not to exceed 180 days, depending on use and exposure to particulates, contaminants and sensor poisons. A daily bump test should be performed to ensure a functional response of all sensors and alarms.

- **BUMP TEST** is defined as a brief exposure to sensor gases, typically 10-20 seconds, just long enough to indicate that the sensors are responsive and the alarms are functional, without concern for a quantitative measurement.
- **CALIBRATION** is defined as exposing the sensor(s) to a known concentration standard gas for the full calibration time (typically 30-60 seconds, but longer for HCN) and setting the reading of the sensor(s) equal to the concentration of the calibration gas.

Calibration intervals and bump test procedures may vary due to sensor type, ambient conditions, local regulations and/or the user's company policies.* Automatic reminders for calibration and bump tests can be set up in the CAL? Menu or using the mPower Suite software (see Section 6.1). When a calibration or bump is due, a small icon is displayed next to the sensor name:  for Cal and  for Bump as shown below:

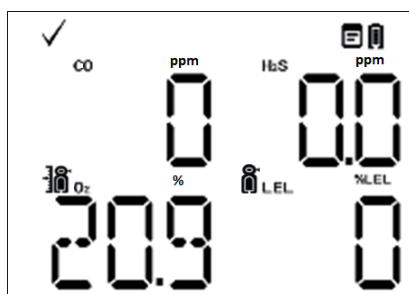

Calibration is also required if:

- The sensor has failed in a previous bump or calibration
- The sensor module has been replaced with one whose calibration is overdue.
- A new sensor is installed.

For more on calibration frequency see Tech/App Note 3 “How Often to Calibrate Gas Detectors”.*

* The calibration frequency must be defined by the user's company policy because each application is different and may cause a sensor's sensitivity loss for various reasons out of mPower's control, such as liquids, dirt or corrosion preventing gas from reaching a sensor, or exposure to chemicals that poison a sensor's function. Exotic gas sensors tend to need more frequent calibration than common O₂, LEL, CO and H₂S sensors. In general we recommend a bump test before each day's use to test sensor response and alarm function. A calibration check can be performed by applying a known concentration gas to see if the sensors still respond within typical limits. Cal check intervals can be increased as the user gains experience in the application. If a bump or cal check fails, the instrument should be given a full calibration. We recommend no more than one month between full calibrations, but this can be extended for up to 6 months if company policy allows.

5.4.1 Recommended Span Gases

5.4.1.1 Span Gas Selection

mPower recommends a mixture of 60 ppm CO / 15 ppm H₂S / 2.5% CH₄ (50% LEL) / 18% O₂, (balance N₂) to allow calibration of 4 standard sensors at the same time. Other calibration gas options are listed in the table below.

Sensor	Resolution-Range	Calibration Gas
LEL/O ₂ /CO/H ₂ S 4-Gas Mix	See sensors below	50%LEL/18% O ₂ /60 ppm CO/15 ppm H ₂ S
Oxygen (O ₂)	0.1-30% Vol	18 % Vol O ₂ and/or 100% N ₂ to set zero
Combustibles Pellistor (LEL%)	1-100%LEL	50 %LEL (2.5 % Vol Methane, balance air)
Hydrocarbons NDIR (LEL%)	1-100%LEL	50 %LEL (2.5 % Vol Methane)
CO (Carbon Monoxide)	1-1000 ppm	60 or 100 ppm CO
H ₂ S (Hydrogen Sulfide)	0.1-100 ppm	15 or 25 ppm H ₂ S
HCN (Hydrogen Cyanide)	0.1-50 ppm	10 ppm HCN
SO ₂ (Sulfur Dioxide)	0.1-20 ppm	5 ppm SO ₂

Note: Use balance gas of air if available, otherwise use nitrogen balance gas (except pellistor LEL must have oxygen)

5.4.1.2 Alternative Calibration Compounds for LEL Sensors

Because LEL sensors are broadband detectors, they can be calibrated with many possible gases. The type of calibration gas is selected from a list of over 50 compounds in mPower Suite (Section 6), typically methane, but propane and pentane are also commonly used. The measurement gas is also selected in mPower Suite. Correction Factors (CFs) are calculated and automatically applied to make the display read in equivalents of the Measurement Gas. Note that CFs are very different for NDIR sensors than for pellistor sensors. Thus far, CFs are only implemented for the pellistor LEL sensors, while for the NDIR sensor only methane can be used. TA Note 7 gives comprehensive lists of factors for both pellistor and NDIR LEL sensors along with slightly adjusted values for EMEA countries. Contact mPower for help in implementing any of these alternative Correction Factors.

5.4.2 Calibration Procedures

5.4.2.1 Air Calibration

Air calibration sets the zero baseline for toxic and combustible gas sensors and 20.9% for oxygen. It is done in normal fresh air or other clean air source. It is always best to zero the MUNI before Span Calibration, rather than after.

- Enter Configuration Mode and the CAL? sub-menu, where the first item is Air Calibration:
Config Mode → CAL? → AIR CAL?

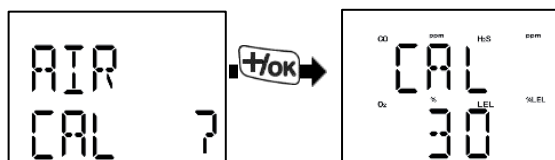

- Press Left [+/OK] and a 30-second count-down starts. When finished, “PASS” or “FAIL” is displayed. To Abort, press Right [⏻/↓] at any time during the count-down.
- The oxygen sensor performs a Span (set to 20.9%) during Air Calibration and can be Zeroed (set to 0.0%) using nitrogen in the Single Span menu.

5.4.2.1 Multi-Gas Span Calibration

Select the proper Span Gas as described above and check the gas cylinder to ensure that the concentrations match the Span Gas Value(s). If not, adjust the value(s) as described below. Also, check the cylinder expiration date and do not use expired gas.

- Enter Configuration Mode, enter the CAL? sub-menu and scroll to MULTI SPAN?:
Config Mode → CAL? → → → MULTI SPAN?
- Press Left [+ / OK] and the span gas concentrations are shown:

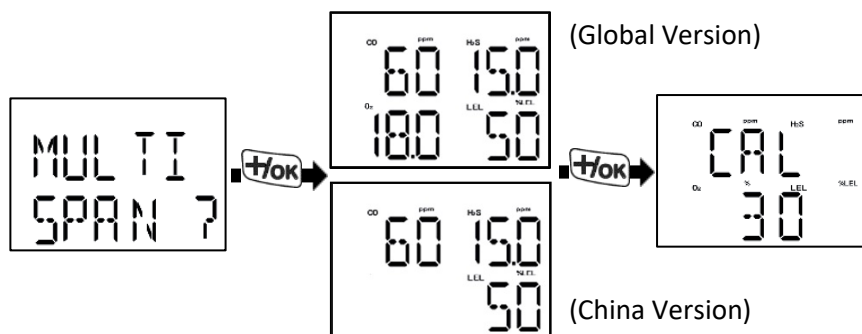

- Connect the calibration cap to the front face of the MUNI and start the span gas flow using preferably a 0.3 - 0.5 LPM regulator (range 0.3 - 1.0 LPM).
- Press Left [+ / OK] and wait for the 30-second count-down timer and “PASS” or “FAIL” calibration result.
- To abort, press Right [⏏ / ↓] at any time during the count-down.
- Turn off the gas supply, remove the calibration cap and exit the CAL? menu.
- Oxygen Sensor parameters during Multi-Gas Span Calibration:
 - Span is any concentration 0-30% **other than** 20.9% (Air Cal is used to set 20.9%).
 - In the Global version, oxygen is default enabled and set at 18%.
 - In the China version, oxygen is default disabled and set a 0% for separate Single Span.

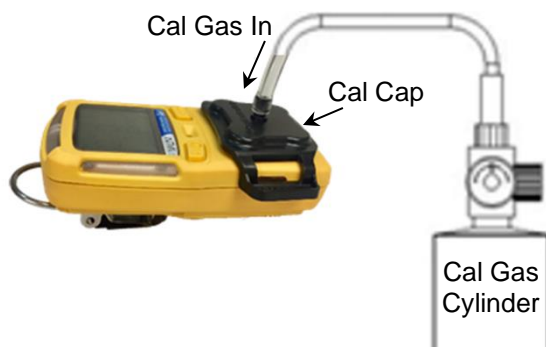

NOTE: If the sensor calibration fails, try again. If calibration fails again, turn off the power and replace the sensor. **⚠ WARNING!** Do not replace sensors in hazardous locations!

5.4.2.2 Single-Gas Span Calibration

Single-Gas Span Calibration can be done for gases not available in a mixture, or for the oxygen sensor at values lower than 20.9%. We recommend using 18% O₂ for work in normal breathing air and 0% O₂ (pure nitrogen) for work in inert atmospheres. If the Multi-Span gas mixture contains a sub-20.9% O₂ level, it can also be used for an oxygen Single Span done separately.

- Enter Configuration Mode, enter the CAL? sub-menu and scroll to SINGLE SPAN?:
Config Mode → CAL? → → SINGLE SPAN?
- Press Left [+ /OK] and the first sensor name is flashing. Move the cursor to the desired sensor.
- Press Left [+ /OK] and the span gas concentration is shown.
- Attach the Calibration Cap and proceed as for Multi-Gas Span above.

5.4.2.3 Set Span Value

To set the Span Calibration gas concentration:

- Enter Configuration Mode, enter the CAL? sub-menu and scroll to SET SPAN?:
Config Mode → CAL? → → → SET SPAN?
- Press Left [+ /OK] and the first sensor name is flashing. Move the cursor to the desired sensor.
- Press Left [+ /OK] and the span gas concentration is shown.
- Move the cursor to the desired digit and Left [+ /OK] to change the span value.
- Move the cursor to the ? and press Left [+ /OK] to save. Repeat with other sensors as needed.



5.4.2.4 Single- and Multi-Gas Bump Tests

A bump test is a quick check if the sensors and alarms are functioning, without doing a precise calibration. Enter the Configuration Mode CAL? sub-menu and scroll to SINGLE BUMP? or MULTI BUMP?. Then use exactly the same procedures as for Single- and Multi-Gas Span Calibrations, the only differences being the shorter count-down times, and confirming that the appropriate alarms are functioning properly. It is convenient and preferred to use the same gas(es) for Bump Tests as for Span Calibration, although other gas(es) with similar concentrations can be used that the sensor(s) respond to and that activate the alarms.



5.4.3 Cal and Bump Intervals

The Calibration and Bump Test Intervals are the number of days (up to 365) until the MUNI reminds the user to perform these tests again.

- Enter the Configuration Mode CAL? sub-menu and scroll to SPAN INTVL? or BUMP INTVL?:
Config Mode → CAL? → → → SPAN INTVL? → BUMP INTVL?
- Press Left [+ /OK] and the first sensor name is flashing. Move the cursor to the desired sensor.
- Press Left [+ /OK] and the Interval is shown (in days).
- Move the cursor to the desired digit and Left [+ /OK] to change the value.
- Move the cursor to the ? and press Left [+ /OK] to save. Repeat with other sensors as needed.

5.5 Sensor Enable/Disable

Sensors can be disabled if they are not needed for a particular application, or if a sensor fails but the other sensors still provide useful readings.

- To disable or enable a sensor, enter the Configuration Mode SENSOR ONOFF menu:
Config mode →→ SENSOR ONOFF?
- Press Left [+ /OK] to enter and the On/Off status of the first sensor is flashing.

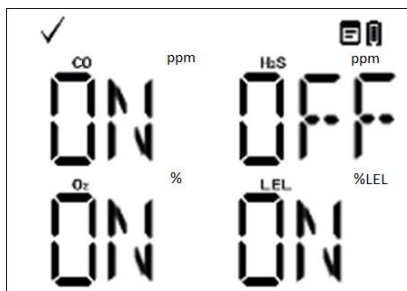

- Press Right [ϕ/↓] to scroll to the desired sensor and press Left [+ /OK] to toggle On/Off.
- Press Right [ϕ/↓] until the display shows SAVE? And press Left [+ /OK] to save.

5.6 Sensor Alarm Settings

All alarm limits can be customized, including High, Low, STEL and TWA alarms.

- Enter the Configuration Mode SENSOR ALARM? menu and scroll to the desired alarm:
Config mode →→→ SENSOR ALARM? → HIGH ALARM? → LOW ALARM? → etc.
- Press Left [+ /OK] to enter the specific alarm sub-menu.
- Scroll Right [ϕ/↓] until the desired sensor is flashing, and press Left [+ /OK] to select the sensor alarm, e.g., HI ALM 20.0?
- Press Right to highlight the desired digit and Left to change the alarm value. Hold down the Left [+ /OK] key for continuous number scrolling.
- Move the cursor to the ? and press Left [+ /OK] to save.
- Repeat for other alarm limits as needed.

5.7 Monitor Set-up

This menu is used to adjust the date and time as for any numerical inputs. The date is in Year-Month-Day format and the clock is in 24-hour format. The clock can also be set by synchronizing with the PC, if that option is enabled using mPower Suite.

- Enter the Configuration Mode MNT SETUP? menu and scroll to DATE? Or TIME?:
Config mode →→→ MNT SETUP? → DATE? → TIME?
- Press Left [+ /OK] to enter the specific sub-menu.
- Scroll Right [ϕ/↓] until the desired digit is flashing, and press Left [+ /OK] to change the value. Hold down the Left [+ /OK] key for continuous number scrolling.
- Press Right [ϕ/↓] repeatedly until SAVE? Is displayed and press Left [+ /OK] to save.

6. PC Communication

The mPower Suite software can be used to 1) download logged events, 2) upload configuration parameters to the instrument and 3) upgrade the instrument firmware. mPower Suite and instrument firmware can be downloaded from our website at <https://www.mpowerinc.com/software-downloads/>.



Micro B (5-Pin) to USB cable

6.1 Connecting and Configuring

- Turn on the instrument, cycle through the Main User Mode and enter COMM MODE.
- Slide the charge/comm connector into the bottom of the MUNI. Connect the USB cable to the PC and the Micro-USB end to the charge/comm connector in the instrument.*
⚠**WARNING!** Connect only in non-hazardous environments!
- Start mPower Suite on the PC and click the “Search” button to find the instrument.
- Find the instrument in the left bar Device Connected list. Click on the S/N to get the configuration file from the instrument.
- Edit the configuration parameters as desired including those under the tabs for each sensor in the upper right. Click “Write” to upload the configuration to the instrument.
- “Read” allows downloading the current configuration file from the instrument.
- “Save” allows storing the current configuration file to the PC.
- “Load” allows calling up a stored configuration file from the PC to mPower Suite.
- To update the instrument firmware, select “Firmware Upgrade”. The firmware must first be downloaded to the PC from the mPower website www.mPowerinc.com.

*NOTE: Any locally-obtained USB A to Micro B USB cable will work for battery charging, but will not work for communication with mPower Suite software. The mPower USB cable P/N M011-3003-000 is required for a PC to recognize the instrument and communicate with mPower Suite.

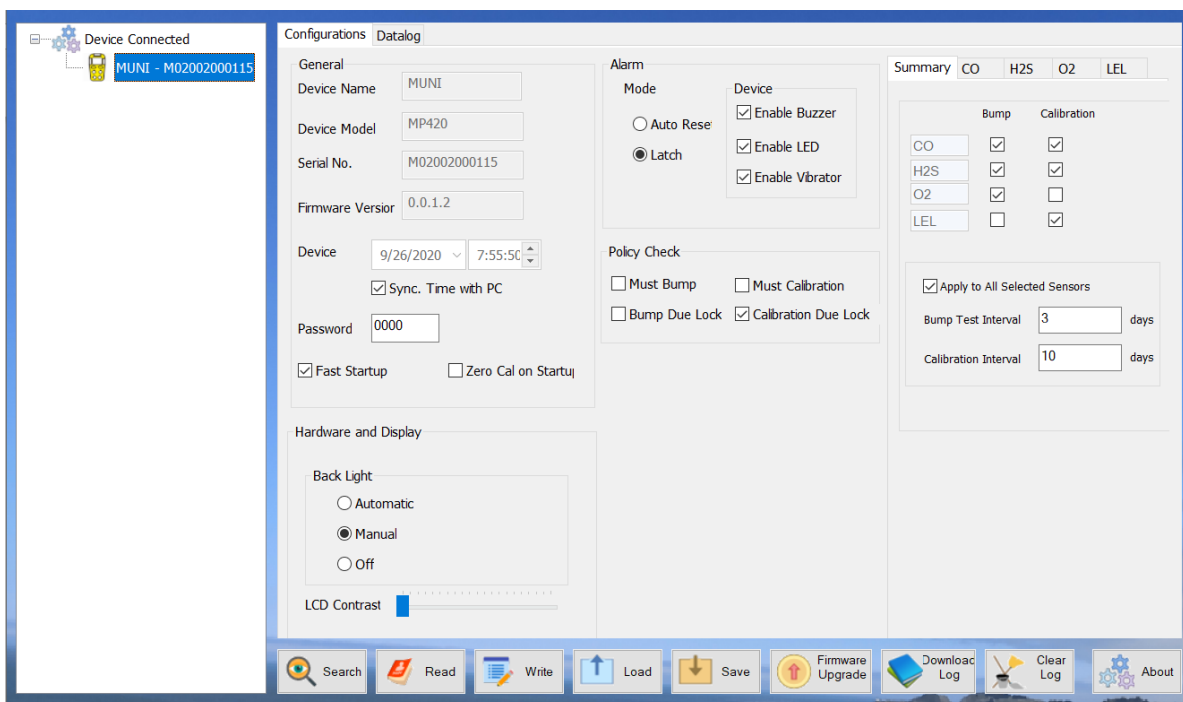

mPower Suite Main Configuration Screen

6.1.1 Configuration Details

These items can be set up using mPower Suite and are not accessible in the instrument Configuration Mode or are easier to manage in mPower Suite.

- **Alarm Mode: Auto Reset** means that the alarm signals stop as soon as the alarm condition no longer exists. **Latched Mode** means the alarm continues until the user acknowledges it by pressing the Left [+ / OK] key. Under **Alarm Device**, the user can check or uncheck the boxes to enable or disable any alarm signal.

⚠ WARNING!

Disabling all of the alarm devices prevents notification of hazardous gas concentrations and can lead to serious injury or death!

- **Backlight: Automatic** turns on automatically under dim light conditions and **Manual** requires the user initiation by pressing either the Left [+ / OK] or Right [⬇ / ⬆] keys.
- **Policy Check:**
 - “**Must Bump/Cal**” locks the instrument from being used once the **Bump** or **Cal Interval** is reached, until a Bump or Cal is performed.
 - “**Bump/Cal Due Lock**” allows overriding the Bump/Cal requirement by entering the instrument password.
- **Bump** and **Calibration Intervals** can be set in the far right panel, either under the Summary tab if all sensors are the same, or individually under each sensor tab. The software allows setting intervals between 1 and 365 days, but for all MUNI instruments calibration intervals should not exceed 180 days. Notifications and Policy Check are disabled by setting the intervals to zero.

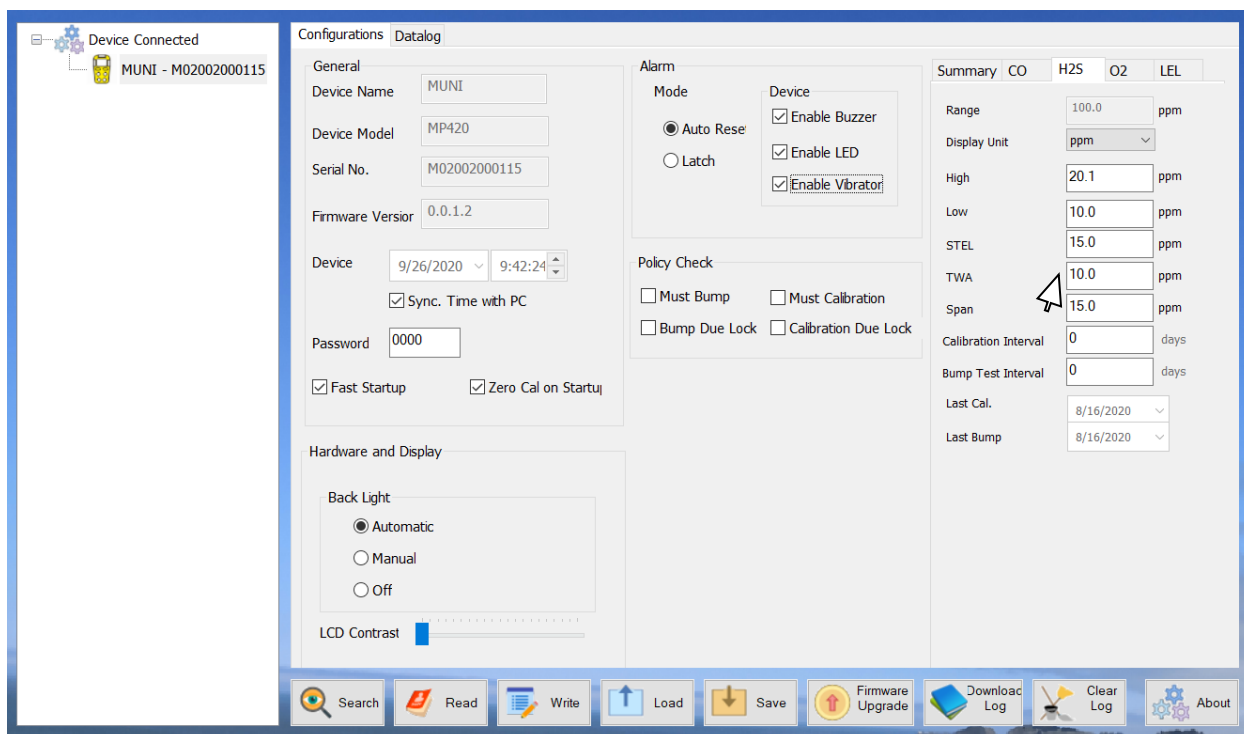

mPower Suite Alarm, Span and Bump/Cal Interval Settings

- Individual **Sensor Alarm Levels**, **Span Gas Concentrations** and **Display Units** can also be set in the sensor tabs in the far right panel.
- **LEL Calibration Gas** and **Measurement Gas** can be selected from a list of over 50 compounds for the Pellistor LEL sensor. If Measurement and Cal Gas are different, a correction factor is calculated and applied to make the sensor display in %LEL equivalents of the measurement gas. (About 20 factors are available for the NDIR LEL sensor – contact mPower for assistance in applying these factors.)

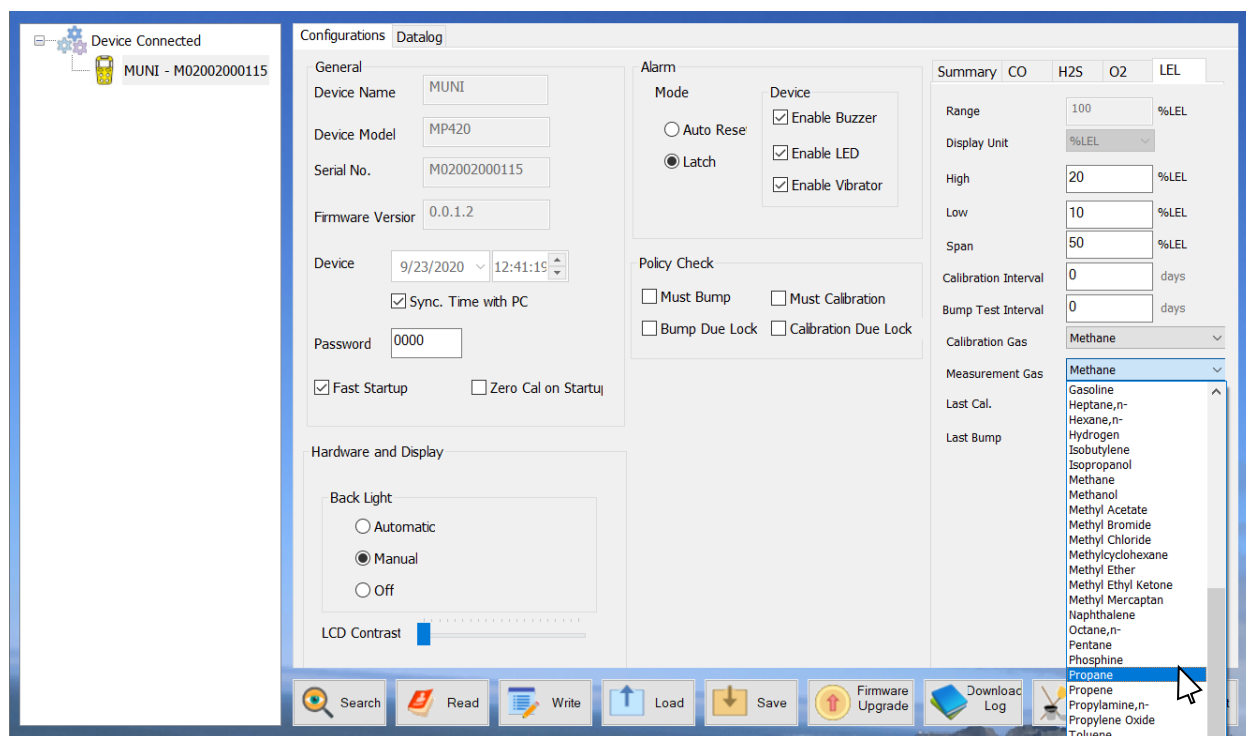

mPower Suite LEL Gas Selection

6.2 Event Log Retrieval and Calibration Certificates

The MUNI automatically stores up to 1000 events consisting of bump test results, calibration results, and alarm events that last for more than a few seconds. When the storage is full, the oldest data get overwritten by the newest event.

- Event logs can be retrieved either directly from the instrument or via the MuniDock.
- To download the event log to the PC, select “Download Log” on the bottom panel bar. This process may take a few minutes because datalogging is always on and many files can be generated. The event files will appear under the “Datalog” tab on the top of the screen. Below is a sample screen of event log information listing event type, readings, and other auxiliary information.
- To export data to a csv file readable by Excel or other spreadsheet software, move the cursor over the right data panel, click the right mouse button, and then select either the current Event file or all the stored files (Whole Datalog).

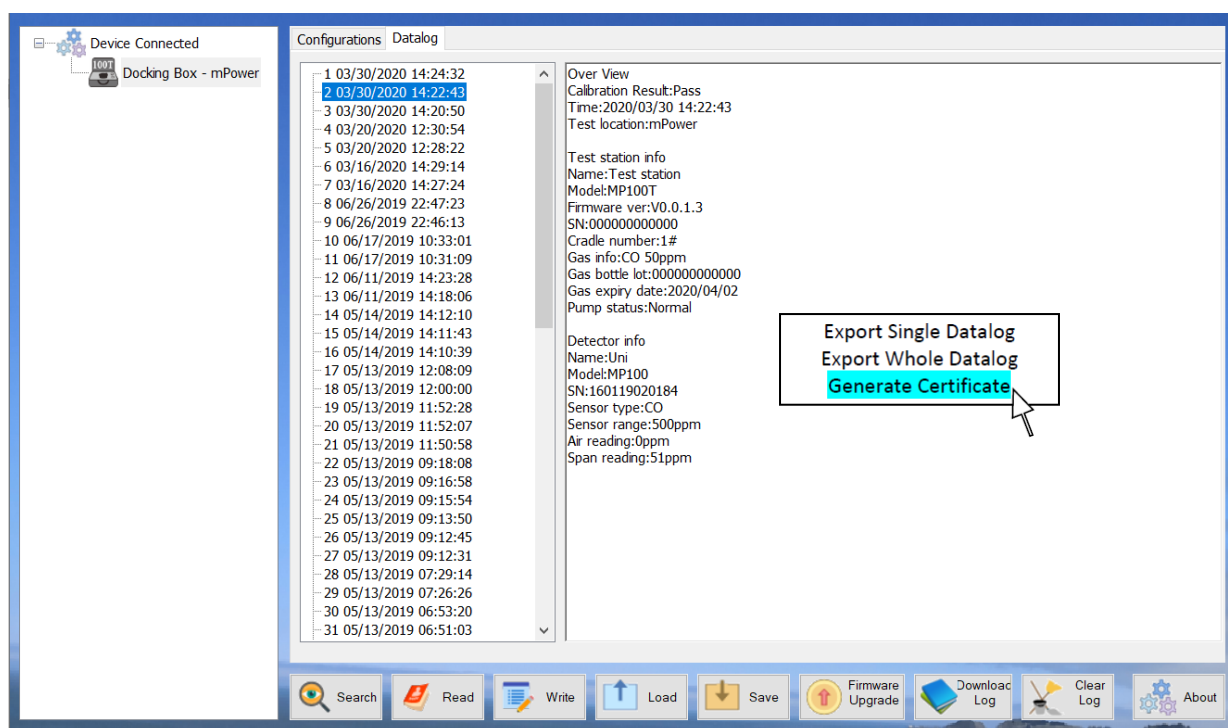

Bump/Calibration/Alarm results recalled from the MUNI

- To print a Calibration Certificate, right-click the mouse in the right panel and select Generate Certificate. Enter any desired information such as operator name and cylinder lot number, and click Print at the bottom.

CERTIFICATE OF MONITOR CALIBRATION

DATE: 6/ 3/2020 ASSET ID #:

CALIBRATED BY: TITLE:

APPROVED BY: TITLE:

SIGNATURE (with date):

INSTRUMENT INFORMATION CALIBRATION RESULT: PASS

Brand: mPower Electronics
 Serial #: 040919080238
 Model #: MP420

Sensor Type	Gas	Concentration	Post Cal Reading	Sensor Serial # ^
H2S	H2S	15ppm	15.3ppm	840219080241
O2	O2	18%	17.9%	840319080172
LEL	CH4	50%LEL	49%LEL	842519080324
CO	CO	60ppm	52ppm	840119080420 v

Calibration Gas	Mix	Calibration Gas	Single	Monitor Kit Complete
Expiration Date	12/31/2020	Expiration Date	12/31/2020	
Lot # 1	000000000000	Lot # 2		Missing Parts
Manufacturer		Manufacturer		

Print Certification Cancel

Calibration Certificate Generated from MUNI directly or via MuniDock

7. MuniDock Operation

7.1 MuniDock Cal/Bump Procedures

- For best results, download the latest version of mPower Suite at <https://www.mpowerinc.com/software-downloads/>.
- Further instructions will be included when the MuniDock becomes available.

7.2 MuniDock Data Download and Calibration Certificates

- Instructions will be included when the MuniDock becomes available.

8. Maintenance

The MUNI requires little maintenance, aside from daily battery charging (see Section 2), regular filter replacement, and sensor replacement as needed (1 to 3 years depending on sensor and use conditions). The battery may need replacement after long service or extreme use conditions.

8.1 External Filter

Use an external filter in environments with excessive dust or liquid aerosols. The filter attaches to the front housing covering all four sensor gas inlet ports.

NOTE: The external filter will slow the response of the MUNI sensors. Replace the filter when it is visibly dirty or when response times become noticeably long.

8.2 Replacing Internal Filter, Sensors, LCD or Battery

⚠ WARNING!

Open the instrument housing only in non-hazardous locations.

1. Turn off the instrument.
2. Remove the six screws in the back of the instrument.
3. Turn the instrument over, lift off the front cover.
4. **Sensors:** Carefully lift out each sensor to be inspected or replaced.
Install the replacement sensor. Make sure the electrical contact pins are aligned with the holes in the PC board and that the sensor is seated firmly. Sensor locations are marked on the circuit board and sensors cannot be exchanged with different types.
5. **Filter:** On the inside of the front housing cover, peel back and replace the white filter pad and/or the black sensor gasket, as needed.
6. **LCD:** Lift out the LCD and place the electrical ribbon of a new LCD onto the small white connector on the circuit board. Push down the black clamp to secure the ribbon (see below).
7. **Battery:** The battery is soldered onto the bottom of the circuit board and should be replaced at an authorized service center.
8. Ensure that the LCD is connected, replace the housing cover, and tighten the 6 screws.

IMPORTANT! Always perform a full calibration after replacing sensors.



Sensor & LCD replacement



Filter & gasket replacement



LCD connection:

- a. Place LCD ribbon flat onto white bracket
- b. Push black clamp onto ribbon to secure





9. Troubleshooting

Problem	Possible Reasons & Solutions
Cannot turn on power after charging the battery	<p>Reasons: Defective USB cable or charging circuit. Defective battery.</p> <p>Solutions: Try charging the battery again. Replace USB cable or charger.</p>
Lost password	<p>Solutions: Call Technical Support at (408) 320-1266</p>
Buzzer, LED lights, and vibration motor inoperative	<p>Reasons: Buzzer and/or other alarms disabled. Bad buzzer.</p> <p>Solutions: Check under 'Alarm' in mPower Suite that buzzer and/or other alarms are not turned off. Call authorized service center.</p>
Readings abnormally high or low or noisy.	<p>Reasons: Dirty or plugged filter or inlet. Dirty or old sensor. Excessive moisture and water condensation. Incorrect calibration.</p> <p>Solutions: Replace filters. Replace sensor(s). Calibrate unit.</p>
E001 Error; E002 Error	<p>Reasons: LEL Sensor short; LEL Sensor broken</p> <p>Solution: Replace LEL sensor</p>
Cannot communicate with PC	<p>Reasons: Wrong cable. Faulty Charge/Comm connector</p> <p>Solutions: Use mPower USB cable P/N M011-3003-000. Replace charge connector/AC adapter, or push up connector contacts.</p>

For replacement parts please contact an authorized mPower Service Center.

10. Technical Specifications

Detector Specifications

Size	4.33 x 2.36 x 1.10 in (110 x 60 x 28 mm)
Weight	8.0 oz (230 g)
Sensors	<ul style="list-style-type: none"> • Standard LEL (Pellistor), O₂, CO and H₂S • Alternatives CH₄ (NDIR*), O₂ LF (Pb-free†), SO₂ and HCN
Battery	Rechargeable Li-ion pack: ≥ 24 hours (with Pellistor) or extended run time (with NDIR)
Direct Readout	<ul style="list-style-type: none"> • Real-time reading of gas concentration • Visual compliance indicator • Battery status • STEL, TWA, peak and minimum values
Display	Segment LCD, 1.75 x 1.25 in (44 x 32 mm) with LED backlight for enhanced readability
Keypad	2 Operation keys
Calibration	Manual calibration. MuniDock option allows automatic bump test and calibration
Alarms	<ul style="list-style-type: none"> • Audible (95 dB @ 30 cm) • Visual (tri-color LEDs) • Vibration
Datalogging	1000 Events (alarms, function tests and calibrations)
Charging and Communication	<ul style="list-style-type: none"> • Charging with AC adapter or cable to PC • PC comm for data download, monitor setup & firmware upgrades via cable, optional BLE (Bluetooth Low Energy), or MuniDock
Temperature	-4° to 122°F (-20° to 50°C)
Humidity	0% to 95% Relative humidity (non-condensing)
IP Rating	IP-68
Safety Certifications	 Ex da ia IIC T4 Ga Class I, Div 1, Group ABCD (pending)  T4, -20°C ≤ T _{amb} ≤ +50°C  II 1G Ex da ia IIC T4 Ga (pending)  European Conformity (pending)
EMC/RFI	EMC directive: 2014/30/EU
Warranty	2 Years including sensors

Sensor Information

Sensor	Resolution & Range	Response Time (t ₉₀)
Combustibles (Pellistor) (NDIR)*	1 - 100% LEL	15 sec
	1 - 100% LEL CH ₄	30 sec
Oxygen (O₂) (Galvanic) (Lead-free)†	0.1 - 30.0% Vol	15 sec
	0.1 - 30.0% Vol	15 sec
Hydrogen Sulfide (H₂S)	0.1 - 100 ppm	15 sec
Carbon Monoxide (CO)	1 - 1000 ppm	15 sec
Sulfur Dioxide (SO₂)	0.1 - 20.0 ppm	30 sec
Hydrogen Cyanide (HCN)	0.1 - 50.0 ppm	45 sec

* NDIR CH₄ sensor detects methane and most hydrocarbons, but not some combustible gases such as hydrogen, acetylene and carbon disulfide. Contact mPower for assessment or approval for use in practical applications.
† Pb-free (Lead-free) O₂ sensor has a longer life span than the galvanic version, but requires more battery power.

Standard

- MP420 detector including rechargeable Li+ battery, selected sensors and alligator clip
- AC Charging adapter
- Calibration cap
- USB Communication cable
- Quick start guide
- Calibration certificate

Optional

- External filters
- BLE Wireless
- MuniDock MP420T bump & calibration station

All specifications and listed sensors are subject to change without notice. Please check for updates at www.mpowerinc.com.

Technical Support and mPower Contacts

mPower Electronics Inc.

3046 Scott Blvd. Santa Clara, CA 95054

Phone: (408) 320-1266

Fax: (669) 342-7077

info@mpowerinc.com

www.mpowerinc.com

