



Macurco™ DVP-1200 Manual

Detection and Ventilation Control Panel with BACnet Operation Instructions



IMPORTANT: Keep these user instructions for reference.

Table of Contents

- 1 General Safety Information..... 5
 - 1.1 List of warnings 5
- 2 Use Instructions and Limitations..... 6
 - 2.1 DVP-1200 General Description..... 6
 - 2.2 Remote Relay 6
 - 2.3 MRS-485 Modbus Adapter 6
 - 2.4 Features..... 7
 - 2.5 Specifications 7
- 3 Installation Instructions 8
 - 3.1 Location & Mounting..... 8
 - 3.2 Installation..... 9
 - 3.2.1 General Wiring Information..... 9
 - 3.2.2 Installation Diagram..... 10
 - 3.2.3 Power Connection..... 11
 - 3.2.4 Remote Sensor Connection 12
 - 3.2.5 Remote Relay Connection..... 18
 - 3.2.6 Remote Relay Operation..... 19
 - 3.2.7 Horn & Strobe Connection..... 20
- 4 Operations 21
 - 4.1 Power up 21
 - 4.1.1 Initial Operating Mode..... 21
 - 4.2 User Interface..... 21
 - 4.2.1 LCD Display..... 21
 - 4.2.2 Status Lights 21
 - 4.2.3 Keypad 22
 - 4.3 Normal Status Display 23
 - 4.4 ALARM, WARNING, and TROUBLE Status Display..... 24
 - 4.4.1 ALARM Status Display 24
 - 4.4.2 Warning Status Display 25
 - 4.4.3 Trouble Status Display 25
 - 4.5 Ventilation Control 26
 - 4.6 Main Menu 27

- 4.6.1 CONFIGURE SYSTEM? 27
- 4.6.2 MANUAL CONFIGURE?..... 27
- 4.6.3 CONFIGURE RELAYS, H/S, BUZZER? 37
- 4.6.4 COMMUNICATION? 46
- 4.6.5 VIEW SENSORS? 48
- 4.6.6 DATE/TIME – PASSWORD?..... 50
- 4.6.7 EVENTS? 50
- 4.6.8 TECHNICAL SUPPORT? 51
- 5 BACnet 52
 - 5.1 General Information..... 52
- 6 Testing & Maintenance 57
 - 6.1 Testing 57
 - 6.1.1 Relay Functionality Test 57
 - 6.1.2 Horn and Strobe Functionality Test 57
 - 6.2 Maintenance 58
- 7 Appendix A – Table of Figures..... 59
- 8 Appendix C – Replacement Parts 61
- 9 Appendix D – Setup Record 62
- 10 Macurco Gas Detection Product limited warranty 65
 - Technical Support Contact Information 65
 - General Contact Information 65

1 General Safety Information

1.1 List of warnings

 WARNING
Each person using this equipment must read and understand the information in this User manual before use. Use of this equipment by untrained or unqualified persons or use that is not in accordance with this user manual, may adversely affect product performance.
This equipment helps monitor for the presence and concentration level of certain specified airborne gases. Misuse may produce an inaccurate reading, which means that higher levels of the gas being monitored may be present and could result in overexposure. For proper use, see supervisor or User manual, or call Macurco Technical Service at 1-844-325-3050.
DVP-1200 may not function effectively below 32°F (0°C) or above 104°F (40°C). Using the equipment outside of this temperature range may adversely affect product.
Immediately exit any environment that causes an alarm condition on the sensor.
Each time the unit is turned on it performs a self-test, which activates the audible and visual alarms. If the self-test fails, or all the alarms do not activate, do not use and contact Technical Support at 1-844-325-3050.
Do not cover or obstruct audible alarm opening or visual alarm LED. Doing so may adversely affect product performance.
Do not disassemble unit or attempt to repair or modify any component of this instrument. This instrument contains no user serviceable parts, and substitution of components may adversely affect product performance and void product warranty.
Use only for monitoring the gases which the sensors and equipment are designed to detect. Failure to do so may result in exposures to gases not detectable and result in serious injury or death. For proper use, see supervisor or User manual, or Contact Technical Support at 1-844-325-3050. Failure to follow instructions outlined in this user manual can result in sickness or death.

2 Use Instructions and Limitations

2.1 DVP-1200 General Description

The DVP-1200 controller in conjunction with Macurco gas detectors provide automatic control to help maintain an acceptable environment in parking garages or other applications. The DVP-1200 offers an expandable system with up to 192 addressable detectors in the field. This panel also has an additional four relay board option in addition to the existing standard four relay boards. With three analog outputs, four 24vdc drivers and another option for up to two remote relays, the DVP-1200 will fit into any gas detection application.

2.2 Remote Relay

The DVP-1200 incorporates an optional remote relay module (RR-24) that includes a set of two relays mounted in a single box with an RS-485 interface. RR-24 communicates using standard Modbus protocol and can interface with Building Automation Systems, Control Panels or other Control Devices that accept Modbus communications.

NOTE: RR-24 is not a UL 2017 listed product and was not evaluated by Intertek in conjunction with the operation of DVP-1200.

Macurco RR-24 is not intended for use in hazardous locations.

Following are additional specifications and features of RR-24.

- Power: 24 VDC @ 0.5 A max
- Operating Environment: -32°F to 104°F, 0% to 95% RH non-condensing
- Mounting Kit
- 8-bit dip switch address selector
- RS-485 termination uses 4 pin connectors with jumper to select termination.
- Baud Rate: 4800, 9600, 19200 (default), 98400, 57600, 115200 bps
- Parity: Odd, Even (default) and None
- Intended for use in non-hazardous areas such as parking garages, warehouses, or other commercial facilities.
- Overlay LED indicates power and relay activation status.

2.3 MRS-485 Modbus Adapter

The Macurco MRS-485 adapter is an accessory used to convert the 4-20mA analog signal from Macurco 6-Series detectors to a digital Modbus signal for use with the DVP-1200 and other Macurco control panels.

The MRS-485 mounts to the back of a Macurco 6-Series detector installed on a 4" x 4" electrical box supplied by the contractor. An external power source supplies power to the MRS-485 and the detector.

Complete instructions for the MRS-485 Modbus Adapter can be found at <https://www.macurco.com/product/mrs-485/>

2.4 Features

- LCD display showing the status of each transducer and relay
- External keypad for user selection of the transducer/alarm display and setting the configuration (password protected)
- Three RS-485 digital input channels – 192 addressable sensors
- Up to 8 control zones can be defined
- Each zone can be controlled based on transducer signals and/or time of day
- Comes standard with four onboard 10A, 240 VAC SPDT Dry Contact relays
- Up to four optional onboard expansion relays available
- Up to 2 additional remote relays available
- Each relay is configurable with a delay before activation and minimum on time
- Fail-safe operation can be implemented
- Lockable NEMA 4X type enclosure
- Modular input and output connectors
- Ethernet connection for BACnet output (BACnet IP)
- USB connection
- Compatible with Macurco Commercial 6-Series gas detectors, MRS-485 adapter, Horn & Strobe Combo
- Four 24VDC Drivers for external Horn and Strobe
- Three 4-20mA output
- ETL Listed to UL 2017

2.5 Specifications

- Size: 13.0" x 10.0" x 2.75"
- Weight: 12.4 lb. (5.6 kg)
- Enclosure: NEMA 4X rated
- Operating Temperature: 32° to 104°F (0° to 40°C)
- Operating Humidity: 0% to 95% RH non-condensing
- Power Input: 100 – 240 VAC, 1 Amp, 50/60 Hz, single phase
- Relay Rating (4): SPDT, 120/240 VAC, 10 A Max (resistive)
- LCD Display: 320 x 240 Pixels Graphic LCD Display with backlight
- Status Indicators (LED): Power/Trouble, Hush, Warning/ALARM, and Relay
- Audible indicator: Internal buzzer, 90 dBA at 1ft
- External Drivers (4): 24VDC, maximum 250 mA
- Relay on Delay: 0 – 99 minutes in 1 second increments
- Relay Minimum Run Time: 0 – 99minutes in 1 second increments

3 Installation Instructions

3.1 Location & Mounting

The DVP-1200 should be installed in a centralized location, easy to access and protected from environmental elements. A Mechanical room, Alarm Control Room, or other similar areas are recommended.

Mounting holes are provided in the DVP-1200 case at the four corners. See Figure 3-1. The panel should be mounted with space around the panel for access to conduit entry holes provided on the top, bottom, and right side of the panel.



Figure 3-1 – Mounting Holes Back View

3.2 Installation

3.2.1 General Wiring Information

⚠ WARNING

This equipment helps monitor for the presence and concentration level of certain specified airborne gases. Misuse may produce an inaccurate reading, which means that higher levels of the gas being monitored may be present and could result in overexposure. For proper use, see supervisor or User manual, or call Macurco Technical Service at 1-844-325-3050.

Field wiring is completed via modular connectors (provided), except for the safety ground, AC power, and relays. After wiring, simply plug the modular connectors into the matching connectors on the printed circuit board (PCB).

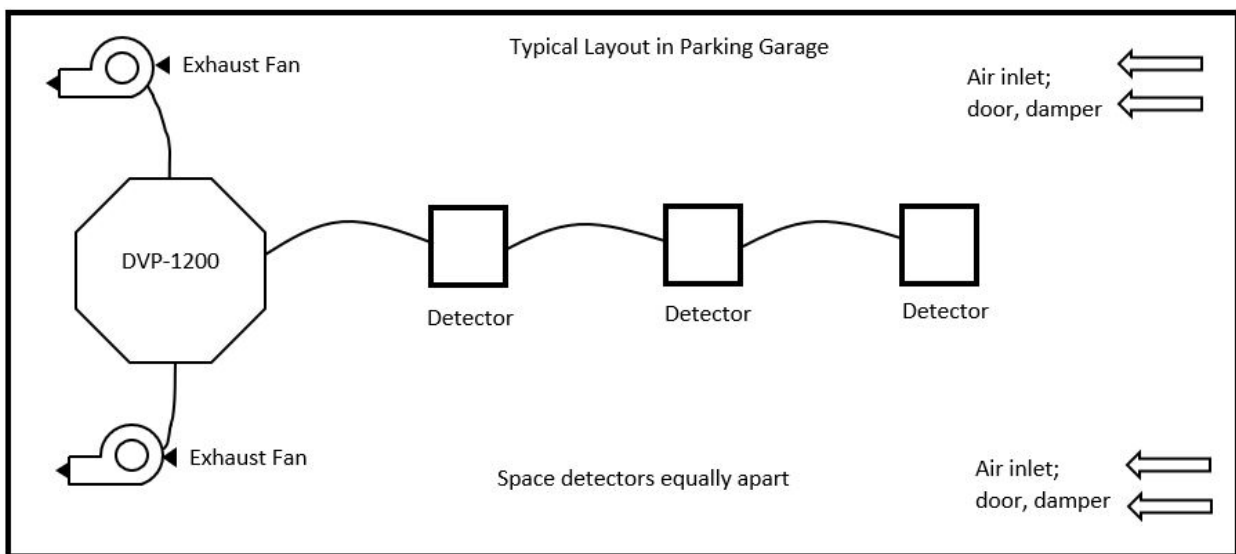

Figure 3-2 – Typical Layout diagram

Note: It is recommended to always install with wires enclosed within the rigid metallic conduit.

The power to the remotely mounted sensors should be size AWG18 (minimum) for short runs. Refer to Table 3-1 for recommended wire gauges.

Wire Gauge	Maximum Run Length	
	(feet)	(meters)
18	263	80
16	418	127
14	665	203
12	1058	322

Table 3-1 – Wire Gauge for run Length

Do not bundle sensor power or sensor signal connections with other AC power cables to prevent electrical interference. If other AC power connections must be bundled with the DVP-1200 sensor cables, the sensor connections should be made with two

twisted pairs of the appropriate gauge, with an overall foil and braid shield. All shields should be terminated at the DVP-1200 end of the cable only.

The power connections to the MRS-485 and remote mounted sensors should be size 18 AWG (minimum) for short runs. Refer to Table 3 1 for recommended wire gauges. The power for the MRS-485 adapter is connected via a two-terminal screw type connector, 12 to 24 VAC or 12 to 24 VDC and no polarity.

The MRS-485 adapter output is wired in the standard 2W-Modbus circuit definition with selectable built-in terminating resistors at the ends of the RS-485 bus. It is recommended to always use twisted wires to reduce noise and allow for reliable data communication over greater distances. For best performance use shielded 3-conductor wire with one twisted pair providing a pair for signal (A & B), common (COM) and shield ground (SHD) connections. Use at least 3-conductor wire with one twisted pair providing a pair for signal (A & B) and common (COM) connections. The Macurco MRS-485 Modbus output is connected via a four-terminal screw type connector.

Running the Modbus cable adjacent to or in the same conduit with high voltage wires is not recommended as there may be interference from the high voltages near the bottom left corner of the panel.

3.2.2 Installation Diagram

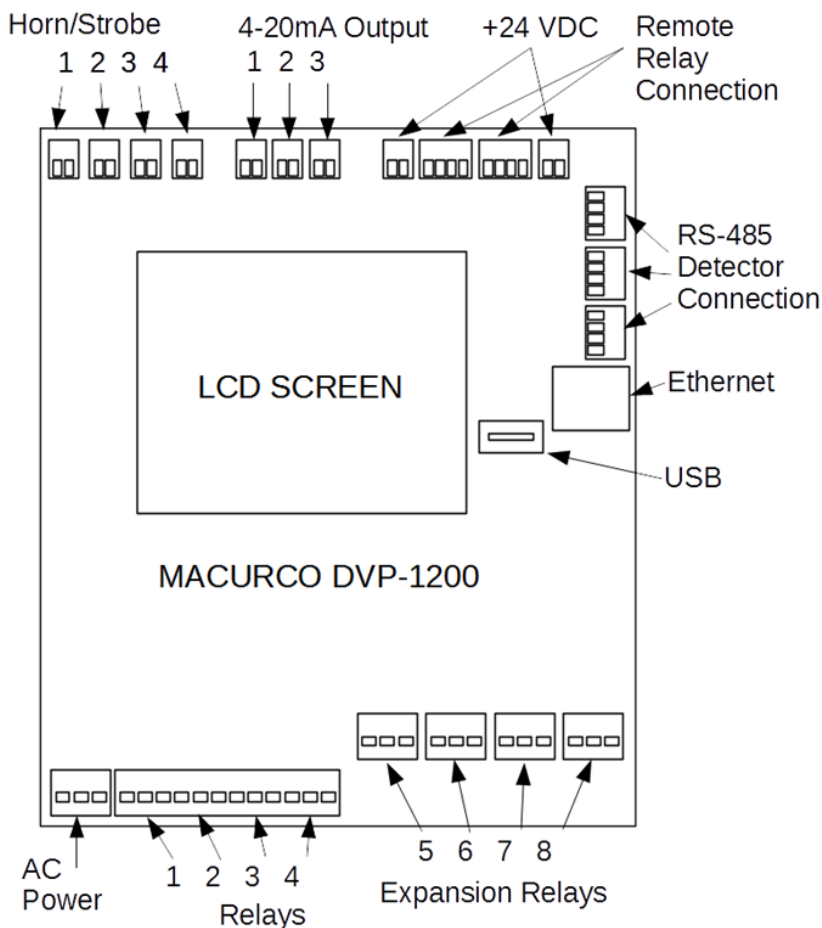

Figure 3-3 – DVP-1200 Board Diagram

3.2.3 Power Connection

The main power cable should be routed into the bottom left conduit entry.

Macurco recommends a minimum wire size of 18 AWG and the wire insulator must be rated for at least 140°F (60°C) service. The power connector will accept wire from 12-24 AWG.

The safety ground wire should be connected to terminal labeled as GND. Connect the wires to the following terminals:

Signal	Connector Label	Pin Label
Line (120/220/240/250 VAC)	AC~	L
Neutral	AC~	N
Ground	AC~	GND

Table 3-2 –

1. The line, neutral and ground wires should be stripped 1/4 in. (6.5 mm).
2. Press down the white button of the connector. You can use flat-headed screwdriver for this.
3. Insert the bare wire into the respective wire cavity of the connector. Refer Table 3-2.
4. Release the white button.
5. Ensure that the wire cannot be easily pulled from the connector.

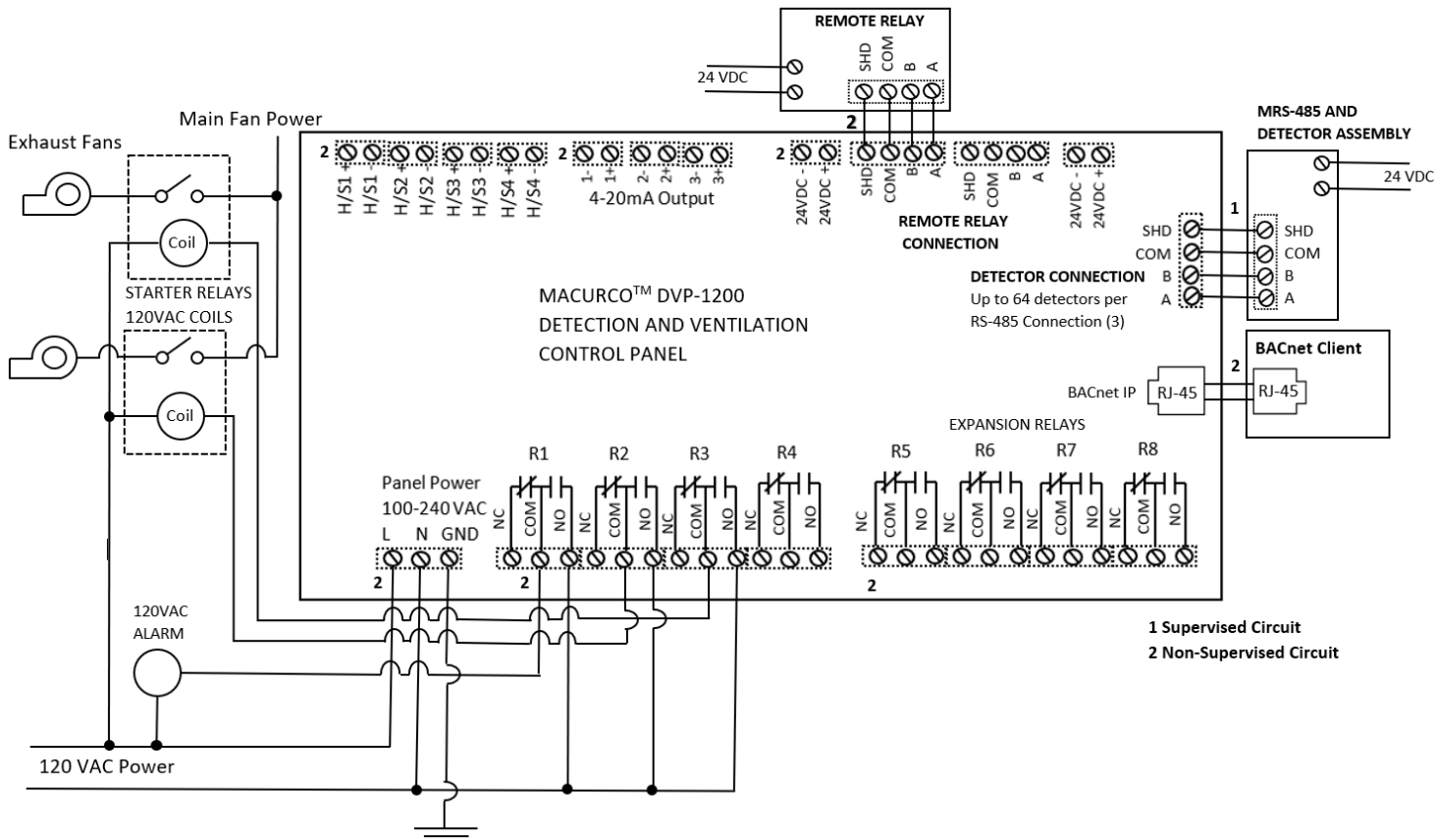

Figure 3-4 – System Wiring Diagram

Note: For ethernet connection, use surge protector (Model: DTK-MRJPOE manufactured by DITEK) and connect one end of the surge protector to DVP-1200 ethernet connection.

3.2.4 Remote Sensor Connection

Remote sensors must be connected to the DVP-1200 at one of the three RS-485 connectors labeled “MRS-485 DETECTOR CONNECTION”.

3.2.4.1 MRS-485 Connection and Operation

The Macurco MRS-485 Adapter converts the Macurco 6-Series 4-20mA analog output to a digital output for use with the DVP-1200 and other addressable network systems.

To install the MRS-485 on a Macurco 6-Series detector,

1. Remove the 4-20mA/Power plug from the Macurco 6-Series gas detector
2. Plug the MRS-485 adapter into the empty socket.
3. Install the provided MRS-485 screw.

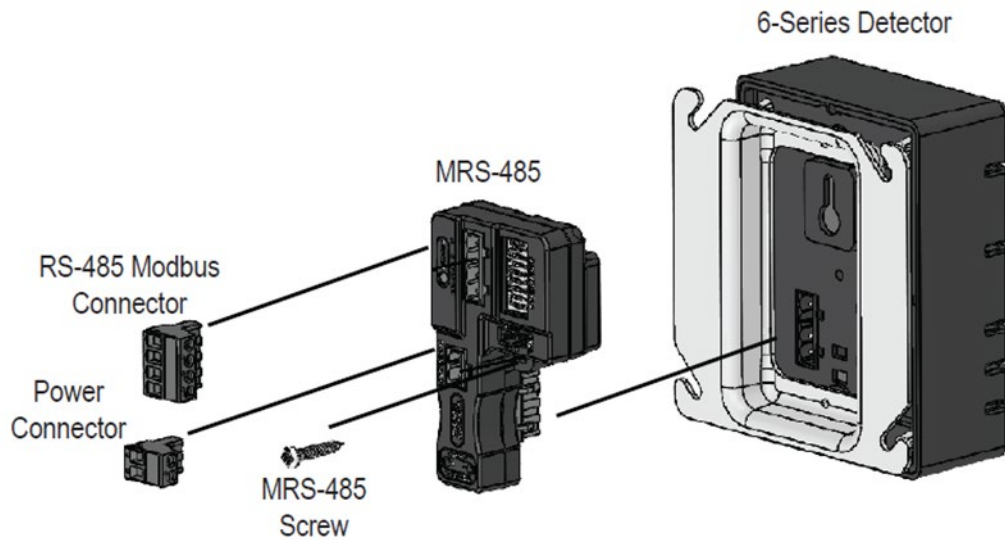

Figure 3-5 – MRS-485 Exploded View

Power connections to Macurco sensors used with the DVP-1200 are polarity-insensitive (no polarity) since a bridge rectifier is connected to the power input terminals. All sensors used with the DVP-1200 panel employ screw clamp terminal blocks for power and signal connections. The polarity of the current loop connections is marked on the printed circuit board of the sensor.

The MRS-485 will monitor the 4-20 mA current output of the detector. At power up and during its warm-up period, the 6-Series detector will communicate its sensor type over the 4-20 current output using a custom protocol. The MRS-485 will automatically register each 6-Series detector as it is programmed with information about all the detectors to which it can be connected. The MRS-485 will use this information to determine the gas level sensed by the 6-Series detector by measuring the 4-20 mA current-loop output during normal operation of the detector.

When the LED is solid GREEN, the operation is normal, the MRS-485 knows the detector type, no errors are detected, and no MODBUS data are being received or transmitted over the RS-485 line.

When the LED is GREEN with random bursts of AMBER, the operation is normal, and data are being received or transmitted over the RS-485 line. The AMBER LED will come on anytime that there is data traffic.

NOTE: After complete system installation, verify all sensors (verify sensor address and sensor type) connected to the panel are detected by the panel and there is not any trouble indication for any of the connected detector.

3.2.4.2 Connection

The Macurco MRS-485 output is connected via a four-terminal screw type connector. The MRS-485 adapter is wired in the standard 2W-Modbus circuit definition with selectable built-in terminating resistors at the ends of the RS-485 bus. The power for the MRS-485 adapter is connected via a two-terminal screw type connector, 12 to 24 VAC or 12 to 24 VDC and no polarity.

NOTE: Running the Modbus cable adjacent to or in the same conduit with high voltage wires is not recommended as there may be interference from the high voltages.

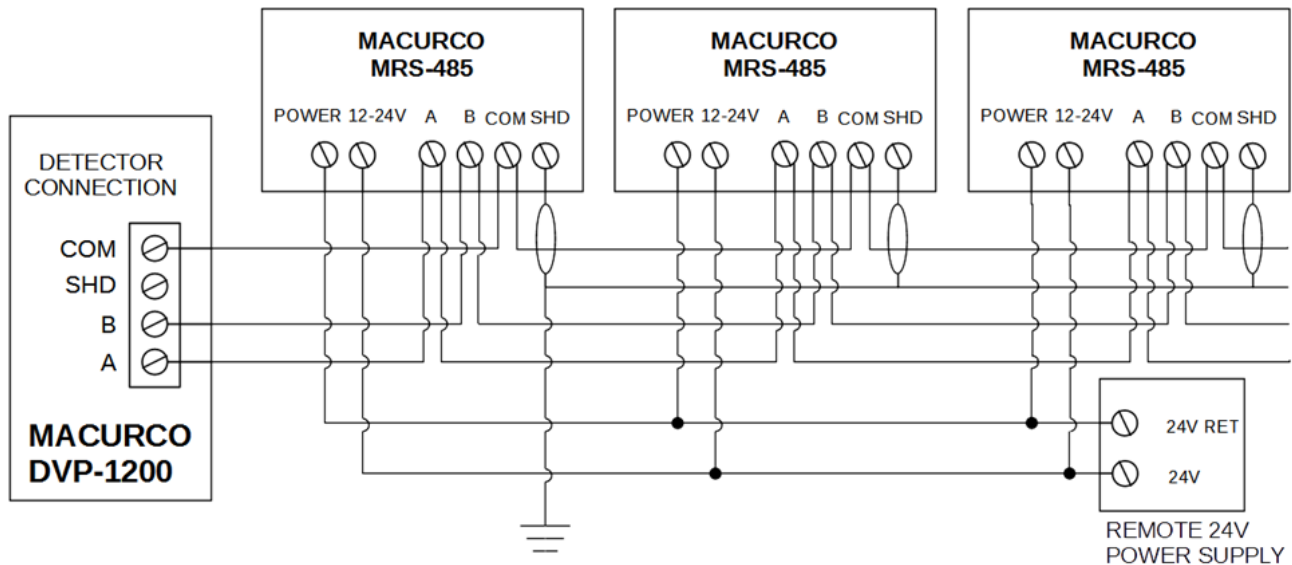

Figure 3-6 – MRS-485 Wiring Diagram

3.2.4.3 Dip Switches and Addressing

Each MRS-485 (and the detector it’s connected to) must be configured to a unique address. If there are 10 detectors on the serial line, then 10 unique addresses must be used, one for each detector. To set the address, use the eight DIP switch positions. For each unit choose the value from 1 to 192 (see chart) and set the eight switches to match the address. UP means ON or 1 and DOWN means OFF or 0. For example, to configure a unit as address “50”, set switches “2, 5, 6” (see Table 3-3) to ON or in the up position (01001100).

NOTE: If CX-6 is assigned address X and connected to DVP-1200, then address X is assigned to NO2 Sensor (Type: 2) and address X+1 is assigned to CO Sensor (Type: 1) by the panel.

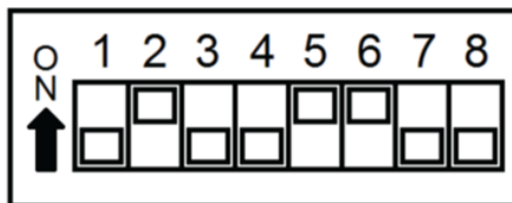

Figure 3-7 –

Address #	"On" Switches	Address #	"On" Switches	Address #	"On" Switches	Address #	"On" Switches
1 =	1	49 =	1, 5, 6	97 =	1, 6, 7	145 =	1, 5, 8
2 =	2	50 =	2, 5, 6	98 =	2, 6, 7	146 =	2, 5, 8
3 =	1, 2	51 =	1, 2, 5, 6	99 =	1, 2, 6, 7	147 =	1, 2, 5, 8
4 =	3	52 =	3, 5, 6	100 =	3, 6, 7	148 =	3, 5, 8
5 =	1, 3	53 =	1, 3, 5, 6	101 =	1, 3, 6, 7	149 =	1, 3, 5, 8
6 =	2, 3	54 =	2, 3, 5, 6	102 =	2, 3, 6, 7	150 =	2, 3, 5, 8
7 =	1, 2, 3	55 =	1, 2, 3, 5, 6	103 =	1, 2, 3, 6, 7	151 =	1, 2, 3, 5, 8
8 =	4	56 =	4, 5, 6	104 =	4, 6, 7	152 =	4, 5, 8
9 =	1, 4	57 =	1, 4, 5, 6	105 =	1, 4, 6, 7	153 =	1, 4, 5, 8
10 =	2, 4	58 =	2, 4, 5, 6	106 =	2, 4, 6, 7	154 =	2, 4, 5, 8
11 =	1, 2, 4	59 =	1, 2, 4, 5, 6	107 =	1, 2, 4, 6, 7	155 =	1, 2, 4, 5, 8
12 =	3, 4	60 =	3, 4, 5, 6	108 =	3, 4, 6, 7	156 =	3, 4, 5, 8
13 =	1, 3, 4	61 =	1, 3, 4, 5, 6	109 =	1, 3, 4, 6, 7	157 =	1, 3, 4, 5, 8
14 =	2, 3, 4	62 =	2, 3, 4, 5, 6	110 =	2, 3, 4, 6, 7	158 =	2, 3, 4, 5, 8
15 =	1, 2, 3, 4	63 =	1, 2, 3, 4, 5, 6	111 =	1, 2, 3, 4, 6, 7	159 =	1, 2, 3, 4, 5, 8
16 =	5	64 =	7	112 =	5, 6, 7	160 =	6, 8
17 =	1, 5	65 =	1, 7	113 =	1, 5, 6, 7	161 =	1, 6, 8
18 =	2, 5	66 =	2, 7	114 =	2, 5, 6, 7	162 =	2, 6, 8
19 =	1, 2, 5	67 =	1, 2, 7	115 =	1, 2, 5, 6, 7	163 =	1, 2, 6, 8
20 =	3, 5	68 =	3, 7	116 =	3, 5, 6, 7	164 =	3, 6, 8
21 =	1, 3, 5	69 =	1, 3, 7	117 =	1, 3, 5, 6, 7	165 =	1, 3, 6, 8
22 =	2, 3, 5	70 =	2, 3, 7	118 =	2, 3, 5, 6, 7	166 =	2, 3, 6, 8
23 =	1, 2, 3, 5	71 =	1, 2, 3, 7	119 =	1, 2, 3, 5, 6, 7	167 =	1, 2, 3, 6, 8
24 =	4, 5	72 =	4, 7	120 =	4, 5, 6, 7	168 =	4, 6, 8
25 =	1, 4, 5	73 =	1, 4, 7	121 =	1, 4, 5, 6, 7	169 =	1, 4, 6, 8
26 =	2, 4, 5	74 =	2, 4, 7	122 =	2, 4, 5, 6, 7	170 =	2, 4, 6, 8
27 =	1, 2, 4, 5	75 =	1, 2, 4, 7	123 =	1, 2, 4, 5, 6, 7	171 =	1, 2, 4, 6, 8
28 =	3, 4, 5	76 =	3, 4, 7	124 =	3, 4, 5, 6, 7	172 =	3, 4, 6, 8
29 =	1, 3, 4, 5	77 =	1, 3, 4, 7	125 =	1, 3, 4, 5, 6, 7	173 =	1, 3, 4, 6, 8
30 =	2, 3, 4, 5	78 =	2, 3, 4, 7	126 =	2, 3, 4, 5, 6, 7	174 =	2, 3, 4, 6, 8
31 =	1, 2, 3, 4, 5	79 =	1, 2, 3, 4, 7	127 =	1,2,3,4, 5, 6, 7	175 =	1, 2, 3, 4, 6, 8
32 =	6	80 =	5, 7	128 =	8	176 =	5, 6, 8
33 =	1, 6	81 =	1, 5, 7	129 =	1, 8	177 =	1, 5, 6, 8
34 =	2, 6	82 =	2, 5, 7	130 =	2, 8	178 =	2, 5, 6, 8
35 =	1, 2, 6	83 =	1, 2, 5, 7	131 =	1, 2, 8	179 =	1, 2, 5, 6, 8
36 =	3, 6	84 =	3, 5, 7	132 =	3, 8	180 =	3, 5, 6, 8
37 =	1, 3, 6	85 =	1, 3, 5, 7	133 =	1, 3, 8	181 =	1, 3, 5, 6, 8
38 =	2, 3, 6	86 =	2, 3, 5, 7	134 =	2, 3, 8	182 =	2, 3, 5, 6, 8
39 =	1, 2, 3, 6	87 =	1, 2, 3, 5, 7	135 =	1, 2, 3, 8	183 =	1, 2, 3, 5, 6, 8
40 =	4, 6	88 =	4, 5, 7	136 =	4, 8	184 =	4, 5, 6, 8
41 =	1, 4, 6	89 =	1, 4, 5, 7	137 =	1, 4, 8	185 =	1, 4, 5, 6, 8
42 =	2, 4, 6	90 =	2, 4, 5, 7	138 =	2, 4, 8	186 =	2, 4, 5, 6, 8
43 =	1, 2, 4, 6	91 =	1, 2, 4, 5, 7	139 =	1, 2, 4, 8	187 =	1, 2, 4, 5, 6, 8
44 =	3, 4, 6	92 =	3, 4, 5, 7	140 =	3, 4, 8	188 =	3, 4, 5, 6, 8
45 =	1, 3, 4, 6	93 =	1, 3, 4, 5, 7	141 =	1, 3, 4, 8	189 =	1, 3, 4, 5, 6, 8
46 =	2, 3, 4, 6	94 =	2, 3, 4, 5, 7	142 =	2, 3, 4, 8	190 =	2, 3, 4, 5, 6, 8
47 =	1, 2, 3, 4, 6	95 =	1, 2, 3, 4, 5, 7	143 =	1, 2, 3, 4, 8	191 =	1,2,3,4, 5, 6, 8
48 =	5, 6	96 =	6, 7	144 =	5, 8	192 =	7, 8

Table 3-3 – Dip Switch Settings

3.2.4.4 Topology

An RS485-MODBUS configuration without repeater has one trunk cable, along which devices are connected, directly (daisy chaining) or by short derivation cables. The trunk cable, also named “Bus”, can be long. Its two ends must be connected on “Line” Terminations. (see [Section 3.2.4.5 Line Termination – End of Line Resistor](#)). The use of repeaters between several RS485-MODBUS is also possible.

The DVP-1200 has three Modbus termination blocks that will accept two trunk cable connections allowing for two MODBUS communication lines. The Trunk cable must be wired in parallel from the panel to the end of line with no off shoots “T-tapping”.

3.2.4.5 Line Termination – End of Line Resistor

The MRS-485 and DVP-1200 are wired in the standard 2W-Modbus circuit definition with selectable built-in terminating resistors at the ends of the RS-485 bus. The MRS-485 and DVP-1200 provide integral termination for the end of line resistors (EOL). The terminations use 4-pin connector with a jumper to select termination: The user selects no termination or one of the two Modbus line termination options. The MRS-485 and DVP-1200 have two-line termination options (100 Ohm and 120 Ohm) available.

Place the EOL jumper on one of the following positions:

- N = No termination (default)
- 2 = 120 ohm
- 1 = 100 ohm

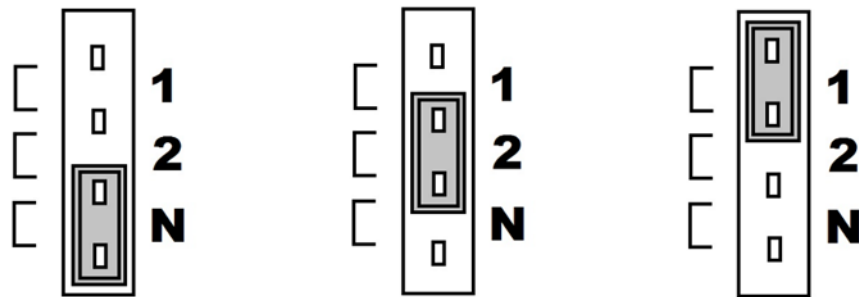

Figure 3-8 – EOL Jumper Settings

3.2.4.6 Baud Rate

At the baud rate of 19200 (default baud rate for Macurco MRS-485 and DVP-485) and with cables less than 1,000 ft. in length, termination resistors are not recommended.

At the baud rate of 19200 and with cables longer than 1,000 ft., termination resistors are recommended.

It is recommended to use an RS-485 type of cable and 120 ohms for termination resistor.

An RS-485 network requires a 3-wire cable: a twisted pair and a third wire. It is difficult to tell whether shielding is required or not in a particular system until problems arise, so it is recommended to always use shielded cable.

When using termination resistors use only 2 resistors, one at each end of the RS-485 transmission line (i.e. 1 at the DVP-485B and 1 at the last/farthest MRS-485).

For any other baud rates calculate when (at what length) termination resistors are required. This is calculated by dividing the length L by the ratio between the new baud rate and 19200 or (x/19200) where x is the new baud rate.

$$\frac{L}{(x/19200 \text{ baud})}$$

For example, if new baud rate is 9600

$$\frac{1000 \text{ ft}}{(9600 \text{ baud}/19200 \text{ baud})} = \frac{1000 \text{ ft}}{0.5} = 2000 \text{ ft}$$

Use termination resistors when cables are longer than 2000 ft.

For example, if new baud rate is 38400

$$\frac{1000 \text{ ft}}{(38400 \text{ baud}/19200 \text{ baud})} = \frac{1000 \text{ ft}}{2} = 500 \text{ ft}$$

Use termination resistors when cables are longer than 500 ft.

NOTE: Other manufacturers may have different recommendations on wire length and EOL resistor usage.

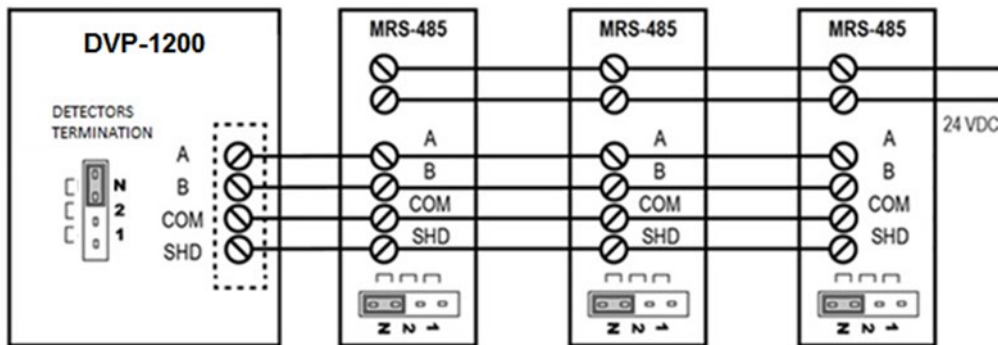

Figure 3-9 –

At 19200 baud rate (default), 1000 ft or less, and using RS-485 or Cat-5 type cable

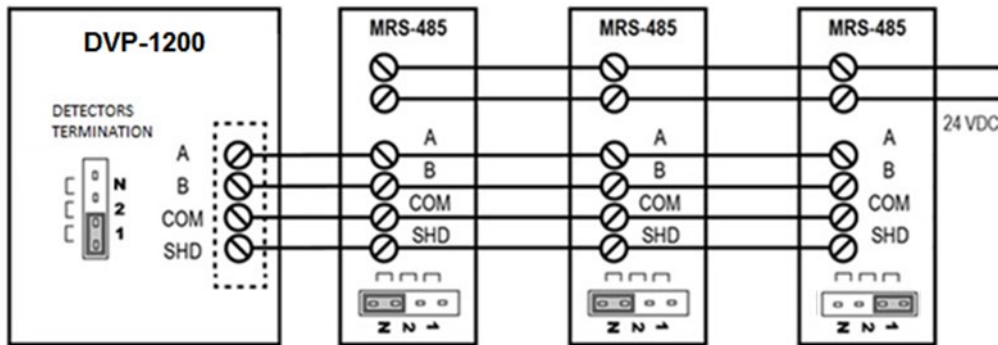

Figure 3-10 –

At 19200 baud rate (default), more than 1000 ft, and using RS-485 type cable

3.2.4.7 Wire Selection

For best performance, use shielded 3-conductor wire with one twisted pair providing a pair for signal (A & B), common (COM) and shield ground (SHD) connections.

For the balanced pairs used in an RS485 system, wire with a characteristic impedance of higher than 100 Ohms may be preferred, especially for 19200 and higher baud rates.

3.2.4.8 Wire Length

For the RS485-MODBUS, the wire gauge must be chosen sufficiently wide to permit the maximum length (1000 m or 3281ft). 24 AWG is always enough for the MODBUS Data. The modular RS-485 connector will accept wire from 16 to 28 AWG. The wire insulator must be rated for at least 140°F (60°C). Category 5 cables may operate for RS485-MODBUS, to a maximum length of 600 m 1968.5 ft.

The maximum length of the trunk cable depends on the

- baud rate
- cable (gauge, capacitance or characteristic impedance)
- number of loads on the daisy chain
- network configuration (2-wire)

For a maximum 9600 Baud Rate and 26 AWG (or wider) gauge, the maximum length is 1000m (3281ft). The derivations must be short, never more than 20m (65.5ft). If a multi-port tap is used with n derivations, each one must respect a maximum length of 40m (131ft) divided by n.

3.2.4.9 Grounding

The Common Circuit (COM) must be connected directly to protective ground, preferably at one point only for the entire bus. The shield should be connected to each detector at the SHD terminal and connected to a ground terminal or chassis only at one end of the bus.

3.2.4.10 External Power Supply

Select a UL Listed NEC Class 2 power supply which can power the MRS-485 units connected to 6-Series detectors.

To determine the required minimum power supply,

- Each MRS-485 connected with a detector is rated at 3.25W.
- The minimum power which the power supply needs to deliver for 12 detectors is figured as: 12 detectors x 3.25 W per detector = 39W
- Therefore, a 24VDC, 60W power supply will work.

3.2.4.11 Power Wire

All field wiring is completed via modular connectors (provided). After wiring, simply plug the modular connectors into the matching connectors on the MRS-485. The power connections to the remotely mounted detectors should be size 18 AWG (minimum) for short runs. Since Macurco detectors are rated for operation between 12 and 24 VDC or VAC, the voltage drop

between the power supply and the MRS-485 should not be an issue if the recommended power wire gauge guidelines are followed.

The terminals will accept wire from 16 to 28 AWG. To install a wire, strip back approximately 0.25 in. (6 mm) of insulation and insert the bare wire into the terminal. Tighten the screw clamp and ensure that the wire cannot be easily pulled from the connector.

3.2.4.12 4-20mA Connection

There are three 4-20mA output modular connectors. The wire terminals for the three 4-20 mA connectors are available at the connector labeled "4-20mA O/P". The connector accepts wires from 16 to 28 AWG. Refer to Figure 3-4 for details.

3.2.4.13 Relay Connection

The wire terminals for the four onboard relays are available at the connectors labeled "R1", "R2", "R3", and "R4". The wire terminals for the optional expansion relays are available at the connectors labeled "R5", "R6", "R7", and "R8".

Each relay will be wired to be either normally open (NO) or normally closed (NC). There is no polarity for these connections. Each terminal can accommodate a wire size from 12 to 24 AWG.

Connect one wire to the COM terminal. For normally open (NO) configuration, connect the other wire to the NO terminal. For normally closed (NC) configuration, connect the other wire to the NC terminal.

To connect wires to the relay terminals,

1. Strip each wire back 1/4 in. (6.5 mm).
2. Press down the white button of the connector.
3. Insert the bare wire into the wire cavity of the connector.
4. Release the white button.
5. Ensure that the wire cannot be easily pulled from the connector.

3.2.5 Remote Relay Connection

In addition to the onboard relays (four standard and four optional), the DVP-1200 can be connected to two additional remote relays. Each remote relay box includes two relays.

The wire terminals for the Remote Relay are available at the connector labeled "REMOTE RELAY CONNECTION".

Remote Relay (RR-24) Mounting:

Macurco RR-24 is shipped with mounting brackets and screws. Install mounting brackets on the back four corner of the enclosure. RR-24 should be mounted with sufficient space all round for access to conduit entry holes provide on the top and bottom side of the unit.

Remote Relay (RR-24) Wiring

All the connectors in RR-24 are spring tightening and will accept wire from 14 to 24 AWG. To connect the wires to terminals, press down the white button of the connector (use flat-headed screwdriver), insert bare wire into respective wire cavity of the connector and release the white button. Ensure that the wire cannot be easily pulled from the connector. Refer to figure below for location of different connectors in RR-24.

The power connections to the RR-24 should be size AWG18 (minimum) for short runs. For longer run follow recommended power wire gauge guidelines. Match the polarity for power connection.

For RS-485 or communication connection it is recommended to always use a twisted wire to reduce noise and allow for reliable data communication over greater distances. For best performance use shielded 3-conductor wire with one twisted pair providing a pair for signal (A & B), common (COM) and shield ground (SHD) connection.

NOTE: Running the RS-485 cable adjacent to or in the same conduit with high voltage wires is not recommended as there may be interference from the high voltages.

RR-24 provide integral termination for end of line resistors (EOL). The termination uses 4-pin connector (labeled J8) to select termination. Place the EOL jumper on one of the following positions:

- NU = No termination (default)
- 120 = 120 Ohm
- 100 = 100 Ohm

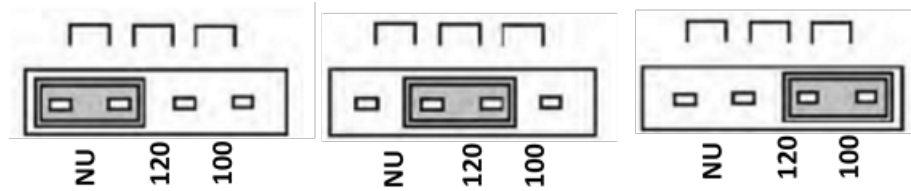

Figure 3-11 - EOL Placement

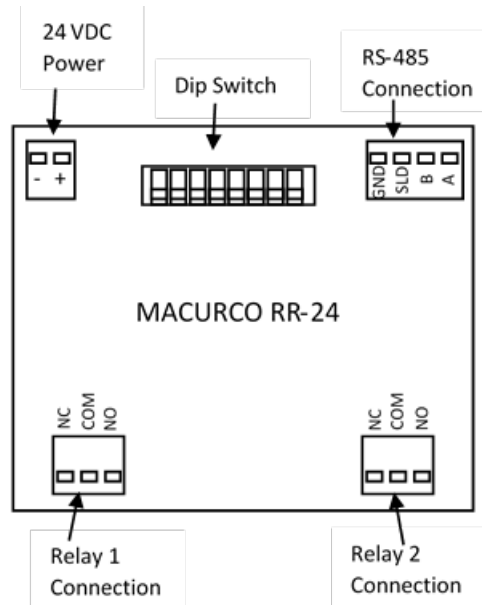

Figure 3-12 – RR-24 Board Diagram

3.2.6 Remote Relay Operation

Power LED will light up green to indicate the unit is operational. TX LED will flash blue to indicate the unit is communicating with DVP-1200. RELAY 1 and RELAY 2 LED will light up red when corresponding relay is activated. Refer to Figure above for location of Relay 1 and Relay 2.

3.2.6.1 Changing RR-24 Settings

The DIP switches are used to set the Modbus address and are also used to change the communication settings. Valid Modbus addresses for RR-24 are from 1 to 192 where switch 1 is the least significant bit (LSB) and switch 8 is the most significant bit (MSB). Address 254 is used to place the RR-24 in programming mode.

3.2.6.2 Programming Mode

When the RR-24 is powered with address set to 254, it enters programming mode. The STATUS LED will be flashing RED and GREEN alternatively every 200 milliseconds to indicate that RR-24 is ready and waiting for the user to enter new communication settings using 8 dip switches. Using the 8 dip switches, use can change the communication settings like baud rate and parity.

When looking at the switches with “Address” marking on top, the switches are defined from left to right.

- Switch 8, switch 7 and switch 6 are used to modify baud rate
- Switch 5 and switch 4 are used to modify parity
- Switch 1 is used to request to save the new settings
- Switch 3 and 2 are unused and should be left in ON position.

Switch 8	Switch 7	Switch 6	Description
OFF	OFF	OFF	Default baud rate (19200 Bd)
OFF	OFF	ON	4800 Bd
OFF	ON	OFF	9600Bd
OFF	ON	ON	19200 Bd (Default value)
ON	OFF	OFF	38400 Bd
ON	OFF	ON	57600 Bd
ON	ON	OFF	115200 Bd
ON	ON	ON	Do not change

Table 3-1 – Baud Rate configuration

Switch 5	Switch 4	Description
OFF	OFF	Default Parity EVEN (Default Value)
OFF	ON	Parity is ODD
ON	OFF	Parity is NONE
ON	ON	Do not change

Table 3-2 – Parity Configuration

Set the switches to the desired value and then set switch 1 to ON and then OFF, and the new settings will be saved in EEPROM.

The result of saving operation is displayed on STATUS LED. Alternating GREEN/OFF every 200 milliseconds indicates saving new settings passed and alternating RED/OFF every 200 milliseconds indicates that saving new settings failed. Once the new settings have passed, disconnect power from the unit, set the address for the device using the address switches and apply power back to unit.

3.2.7 Horn & Strobe Connection

There are four connection terminals for horns and strobes. The modular connectors are located at the top left of the board and are labeled “Horn/Strobe”.

Refer to Table 3 4 for recommended wire gauge vs. run length for the horn & strobe functions (maximum 2.5-volt drop in the wire). The horn & strobe circuits are Class 2 control circuits, so Class 2 conductors should be used.

Wire gauge	Maximum run Length
------------	--------------------

	(feet)	(meters)
24	200	61
22	340	103
20	480	147
18	850	215

Table 3-4 –

4 Operations

4.1 Power up

When power is applied to the panel, the DVP1200 will start up. During the startup sequence, the LED status lights will flash. Once the POWER/TROUBLE light is steady green, the panel is ready to configure. If the panel is powered up for the first-time screen like Figure 4-1 will show up. This screen will allow the installation company information to be entered and saved in the control panel. This information can be accessed or changed via “TECHNICAL SUPPORT” in main menu. Select “MAIN MENU” and hit ENTER to go to DVP-1200 Main Menu.

⚠ WARNING

DVP-1200 may not function effectively below 32°F (0°C) or above 104°F (40°C). Using the equipment outside of this temperature range may adversely affect product.

4.1.1 Initial Operating Mode

If the user has not entered any parameters, the system WILL NOT be controlling the ventilation system. The relays WILL NOT actuate, and the horn and strobe outputs WILL NOT be powered.

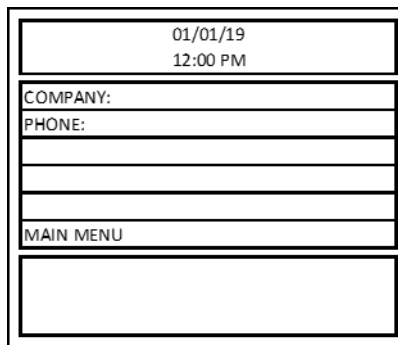

Figure 4-1 –

4.2 User Interface

4.2.1 LCD Display

The LCD display is used to show detailed information about the status of the control system and the configuration parameters.

4.2.2 Status Lights

The POWER/TROUBLE, HUSH, WARNING/ALARM, RELAY status lights indicate the system status and provide the following data:

- POWER/TROUBLE
 - Green – Power is good and there are no trouble indications.
 - Red– Trouble is indicated by a transducer or the panel itself.
- HUSH
 - Off –There are no silenced alarms or warnings or troubles.
 - Red –There are alarms, warnings and/or troubles that have been silenced (gas levels may or may not remain or continue to be at an alarm or warning levels).

- WARNING/ALARM
 - Off – All indicated gas levels are below the warning level
 - Red – One or more gas levels are at or above the alarm level
 - Amber – One or more gas levels are at or above the warning level
- RELAY
 - Off – Relay is not on
 - Green – Relay is on

The overall system status is visible via the status lights as described above. More detailed system information is displayed on the LCD, which can show the more detail information about sensor and panel configuration. A typical status display is shown in Figure 4-2.

4.2.3 Keypad

The keypad is used to select the menu displayed and to enter the configuration parameters, which are stored in the DVP-1200 memory. The keypad consists of ten number keys, four cursor keys, a MENU key, a HUSH key, an ENTER key, a DEL key, and a brightness key.

4.2.3.1 Digit Keys

The digit keys are used to input any alphanumeric information such as sensor numbers or a password.

4.2.3.2 Cursor Keys

In normal mode, (no warnings or alarms indicated), the up and down cursor keys will scroll through menu. The left and right cursor keys can be used to scroll through options on some menu items. Also, the left cursor key can be used to return to the previous higher-level menu.

4.2.3.3 MENU Key

When the system is in the normal display, press MENU to show the Configuration Menu. Press MENU again to return to the normal display.

If the MENU key is pressed from any submenu, the display will return to the configuration menu. Any changes made within the submenus will be lost if it is not saved by the user.

4.2.3.4 Hush Key

The HUSH key is only used to silence the audible indicators (internal buzzer and possible external Horn and Strobe devices). Pressing and releasing the key will silence the internal buzzer. The HUSH key must be held for 3 seconds to silence the Horn and Strobe devices.

The following table shows the silence period for different state of the panel.

State of the Panel	Silence Period
Alarm	5 minutes
Warning	15 minutes
Trouble	8 hours

Table 4-1 –

4.2.3.5 Enter key

The enter key is used to select menu items and to confirm any user input.

4.2.3.6 DEL Key

The DEL key is used to delete characters if an incorrect character is entered or is used to delete the event log.

4.2.3.7 Brightness Key

The brightness key is used to turn the LCD display backlight on or off. It is located on the lower left corner of the keypad.

4.3 Normal Status Display

The normal display shows the date and the time, the status and basic configuration of each zone, and the sensor type and number of sensors connected for each sensor type.

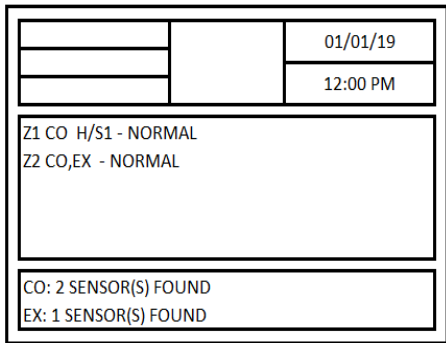

Figure 4-2 –

In the middle box, each zone is indicated by “Z” followed by zone number.

All sensors assigned to the zone are listed by their sensor type. They are indicated by the two-letter abbreviation for the gas type of the sensor.

If a horn/strobe is assigned to the group, it will be indicated by H/Sx where “x” is the horn/strobe number. Similarly, if a relay is assigned to the group, it will be indicated by Rx where “x” is the relay number.

Lastly, the status of each zone is displayed. In normal operating conditions, it will show “NORMAL”. If a sensor in the zone is indicating a gas level that is greater than the alarm or warning levels, the zone status will show “ALARM” or “WARNING” as appropriate. If any of the sensors assigned to the zone goes into trouble, then the status of the zone in the main screen is updated with ‘TROUBLE’.

NOTE: If a sensor is part of final system installation and needs to be monitored, it must be assigned to a zone.

4.4 ALARM, WARNING, and TROUBLE Status Display

If an alarm, warning, or trouble event occurs, the display will automatically switch to the corresponding screen. If multiple events occur simultaneously, the display will only show the event with higher priority. The event priority is (from highest to lowest) ALARM, GAS WARNING, TROUBLE.

4.4.1 ALARM Status Display

When any sensor indicates a gas level that is at or above the configured alarm level for the sensor, the panel will enter ALARM mode, during which the internal buzzer will sound, the WARNING/ALARM LED will be red, and the display will switch to the ALARM status display.

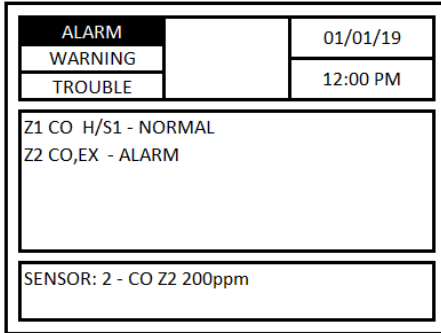

Figure 4-3 –

The top left box will have ALARM highlighted.

If the sensor in alarm is assigned to any of the zone, then status of the zone is updated to indicate ALARM in the middle box of the display.

The bottom box will cycle through all sensors that are in alarm, at five seconds per display. It will display sensor address, gas type, zone number (if assigned to a zone) and corresponding gas reading.



If an external horn and/or strobe are connected and configured to signal an alarm condition, they will also sound when an alarm condition occurs, after a delay if that configuration option is used.

When the HUSH key is pressed, the internal buzzer will be silenced for five (5) minutes. HUSH key must be held for three (3) seconds to silence the horn and strobe.

When all indicators have been silenced, the display will show that alarms have been silenced for five minutes. After any key is pressed (or five seconds), the display will return to normal mode and HUSH led will light up steady red.

If a relay is configured as an alarm relay, it will be turned on when an alarm condition is recognized.

4.4.2 Warning Status Display

When any sensor indicates a gas level that is at or above the configured warning level for the sensor, the panel will enter WARNING mode during which the internal buzzer will sound, the WARNING/ALARM status LED will be amber, and the display will switch to the WARNING status display.

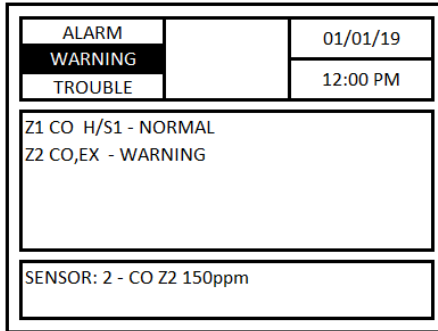

Figure 4-4 –

The top left box will have WARNING highlighted.

If the sensor in warning is assigned to any of the zone, then status of the zone is updated to indicate WARNING in the middle box of the display.

The bottom box will cycle through all sensors that are in warning, at five seconds per display. It will display sensor address, gas type, zone number (if assigned to a zone) and corresponding gas reading.

If the buzzer and/or an external horn and/or external strobe are connected and configured to signal a warning condition, they will also sound when a warning condition occurs. There is a configurable delay before the horn or strobe will sound.

When the HUSH key is pressed, the internal buzzer will be silenced for fifteen (15) minutes. HUSH key must be held for three (3) seconds in order to silence the horn and strobe.

When all indicators have been silenced, the display will show that warnings have been silenced for fifteen minutes. After any key is pressed (or five seconds) the display will return to normal mode and hush led will light up steady red.

4.4.3 Trouble Status Display

If a sensor fails, a connection is lost or the panel itself detects a failure of its own, the panel will enter TROUBLE mode during which the internal buzzer will sound, the POWER/TROUBLE LED will be red, and the display will switch to the trouble status display.

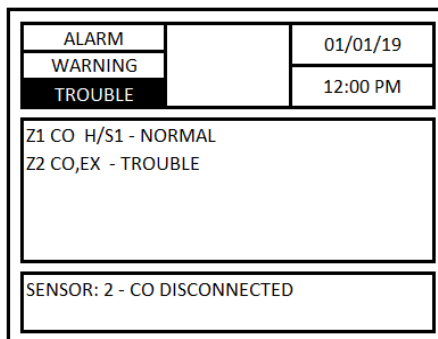

Figure 4-5 –

The top left box will have TROUBLE highlighted.

If the sensor in trouble is assigned to any of the zone, then status of the zone is updated to indicate TROUBLE in the middle box of the display.

The bottom box will cycle through all sensors that are in trouble, at five seconds per display. It will display sensor address, gas type, zone number (if assigned to a zone) and corresponding trouble description.

Possible trouble conditions are:

- Any configured channel has less than 4 mA flowing in the current loop
- A sensor is reporting a trouble condition
- Any configured channel wiring is open or shorted.
- Internal controller board problems are detected.

If an external horn and/or strobe are connected and configured to signal a trouble condition, they will also sound when a trouble condition occurs, after a delay, if that configuration option is selected.

When the HUSH key is pressed, the internal buzzer will be silenced for eight (8) hours. HUSH key must be held for three (3) seconds in order to silence the horn and strobe.

When all indicators have been silenced, the display will show that trouble indications have been silenced for eight hours. After any key is pressed (or five seconds), the display will return to normal mode and hush led will light up steady red.

4.5 Ventilation Control

The ventilation control function operates independently from the alarm function. It provides the ability to configure the DVP-1200 for control of up to 8 zones. Each zone can be configured to control relays and an external horn and strobe if desired.

When more than one zone is controlling a relay it only takes one zone to activate the relay, but all controlling zones must release the relay before it will turn off. Each of the relays, horn, and strobe has independent turn-on delays (to ignore short duration, transient gas signals) and turn off delays (to ensure minimum run times for fans that must run for internal cooling).

A VFD may be enabled and controlled by the DVP-1200 output relays or the DVP-1200 4-20mA output. This allows an operator to change fixed speeds for a VFD if it's used as a stand-alone control.

Here is an example of an application where VFD is controlling the speed of a fan: An operator can close relay 1, 2, or 3 to set the fan speed. If relay 1 is closed, the VFD will operate at 50%, If relay 2 is closed, the VFD will operate 75%, If relay 3 is closed, the VFD will operate at 100%.

Each zone can respond to gas levels indicated by one or more of the sensors, with configurable turn on and turn off concentrations (rising and falling) for each gas type.

For example, each zone can be configured to monitor a separate set of four sensors and control a single relay.

A single sensor may be assigned to multiple zones if desired. Here is an example of a control scheme which has single sensors assigned to multiple zones:

1. One zone monitors all sensors and turns one relay on at a relatively low gas concentration.
2. A second zone monitors the same sensors and turns on a second relay if the gas concentration reaches a higher level.

3. A third zone also monitors the same sensors and turns on the last relay as a signaling device to a live monitor station, as well as turning on an external horn and strobe.

In addition to controlling the relays based on the gas concentration, each zone can have a timed function, e.g. turn on low volume ventilation fans at 7:00 AM and turn them off at 8:00 PM.

4.6 Main Menu

The Main Menu can be entered from normal mode by pressing the MENU key. The display will show the main menu as shown below. All the DVP-1200 configuration menus are password protected. Default password for the panel is '1234'.

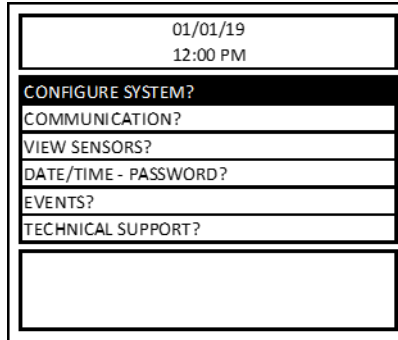

Figure 4-6 –

4.6.1 CONFIGURE SYSTEM?

Menu path: Main Menu/CONFIGURE SYSTEM? /

The DVP-1200 configuration can be changed manually. To enter the configuration menu, a password is required. While the DVP-1200 is in configuration mode, alarm and ventilation control functions continue in the background with the previously set configuration values. If an alarm, warning, or trouble condition is detected, the corresponding led, the buzzer, the horn and the strobe will operate as configured and the display will switch to the corresponding status display.

4.6.2 MANUAL CONFIGURE?

Menu path: Main Menu-->CONFIGURE SYSTEM? -->MANUAL CONFIGURE? -->

Choose “MANUAL CONFIGURE?” to use the DVP-1200 interface to configure the system. Follow the menu as shown below to enter the “MANUAL CONFIGURE?” menu.

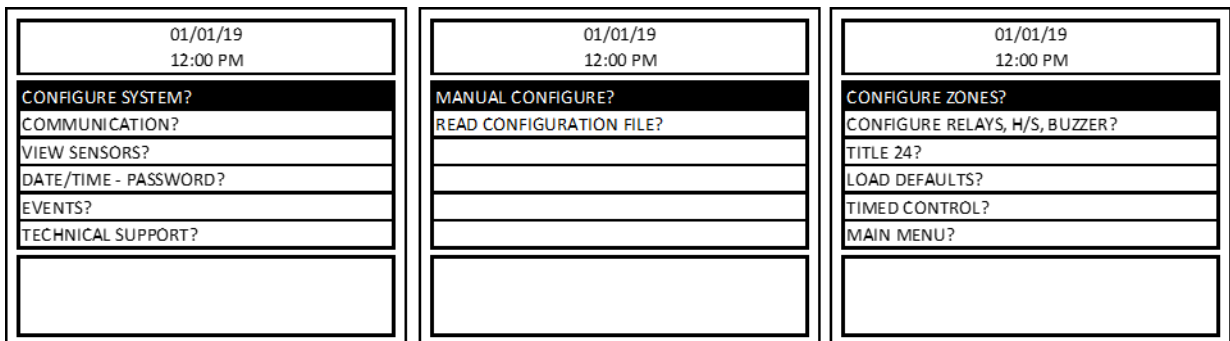

Figure 4-7 –

CONFIGURE ZONES?

REV – 1.3.1

[34-8708-4770-7]

27 | Page

Menu path: Main Menu-->CONFIGURE SYSTEM? -->MANUAL CONFIGURE? -->CONFIGURE ZONES? -->

The “CONFIGURE ZONES?” menu is used to create a new zone, edit an existing zone, or delete an existing zone.

To select a zone for editing select CONFIGURE ZONES from the CONFIGURE SYSTEM menu and press ENTER. The display will show the ADD/EDIT ZONES screen. Press ENTER. Then, enter the zone number and press Enter. The user can enter any valid zone number from 1-8.

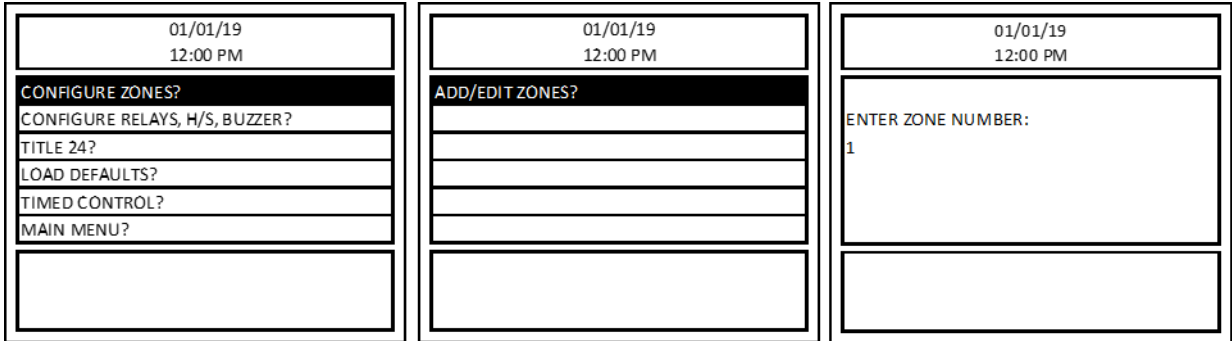

Figure 4-8 –

If the zone has not been configured, the system will skip straight to the zone configuration menu shown below.

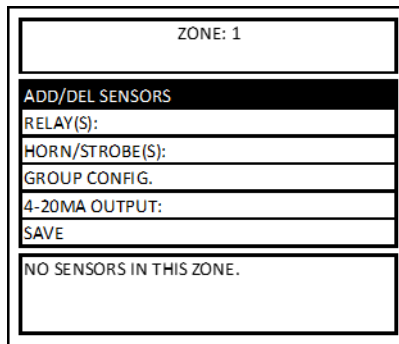

Figure 4-9 –

If the zone has already been configured, the display will briefly show the message “STATUS: ZONE EXIST” as shown below and then the user will have the option to CANCEL, RELOAD CONFIG, or DELETE.

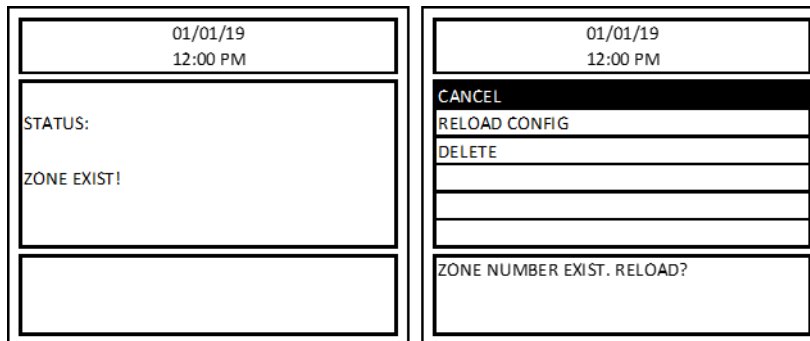

Figure 4-10 –

Choose CANCEL to return to the previous screen.

Choose RELOAD CONFIG to load the previous configuration for edit.

Choose DELETE to delete the zone.

Refer to Figure 4–11 for an example of a zone configuration screen. The top box displays the current zone (ZONE:1) you are configuring during the zone configuration process. The middle box of Figure 4–11 shows that Relay 4, Horn/Strobe 1, Horn/Strobe 3, and 4-20mA Output 2 are assigned to Zone 1. Also, the bottom box of Figure 4–11 shows 2 CO Sensors and 1 EX (Combustible) Sensor are assigned to Zone 1.

4.6.2.1 ADD/DEL SENSORS

Menu path: Main Menu-->CONFIGURE SYSTEM? -->MANUAL CONFIGURE? -->CONFIGURE ZONES? -->ADD/EDIT ZONES-->ADD/DEL SENSORS? -->

To add, delete, and view sensors assigned to the zone, select the ADD/DEL SENSORS option from the zone configuration menu and press ENTER.

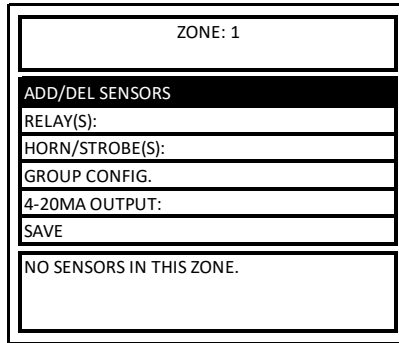

Figure 4-12 –

Refer to Figure 4-13 for sequence of display screen during sensor addition to a zone. To assign a sensor to the zone, select ADD SENSOR and press ENTER. Enter the Modbus address of sensor and press ENTER. The sensor will be added to the zone and the display will return to the ADD/DEL SENSORS menu. The bottom box of the display will be updated with the added sensor information. Repeat the process to add another sensor to the zone.

The bottom box in “ADD SENSOR” and “DELETE SENSOR” screen will list the address of all the sensors currently assigned to the zone.

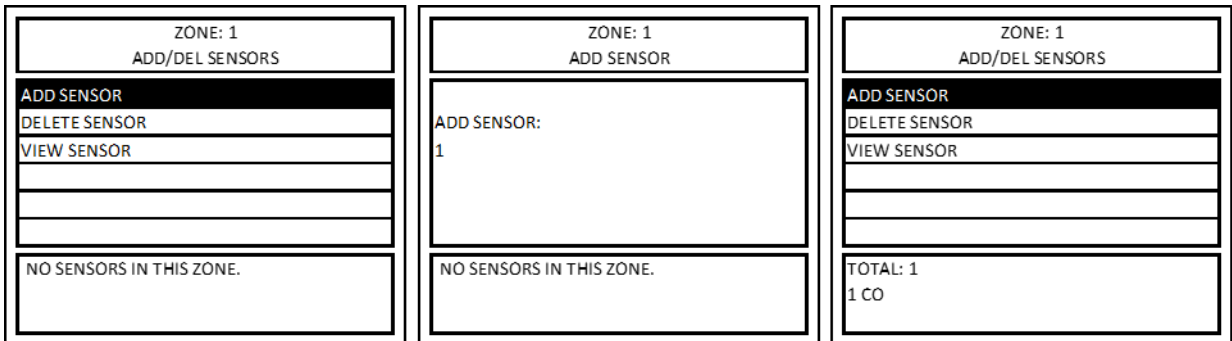

Figure 4-13 –

Refer to Figure 4-14 for sequence of display screen during deleting sensor from a zone. To remove a sensor from the zone, select DELETE SENSOR and press ENTER. Enter the Modbus address of the sensor to remove from the zone and press ENTER. The sensor will be deleted from the zone and the display will return to the ADD/DEL SENSORS menu. The bottom box of the display will be updated to reflect this change.

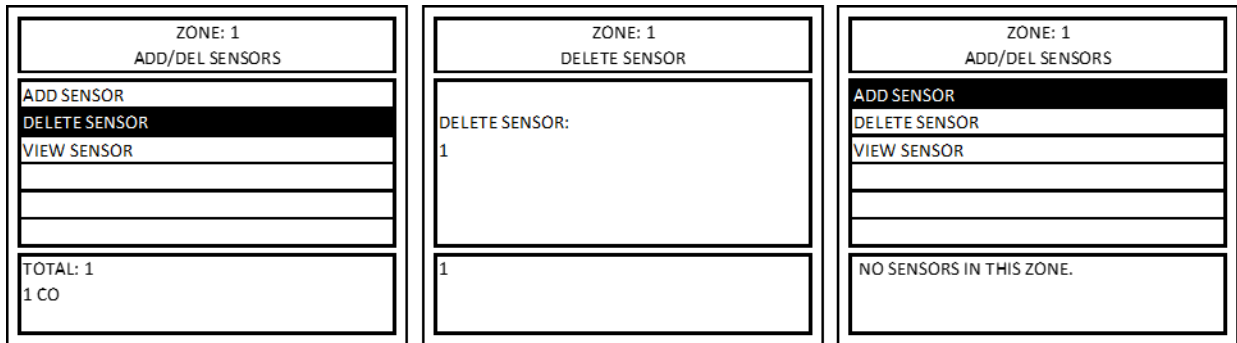

Figure 4-14 –

To view the sensors assigned to the zone, select VIEW SENSOR and press ENTER. The middle box of the display will list the addresses of the sensors assigned to the zone (Refer Figure X). Press ENTER or the LEFT arrow to return to the ADD/DEL SENSORS menu.

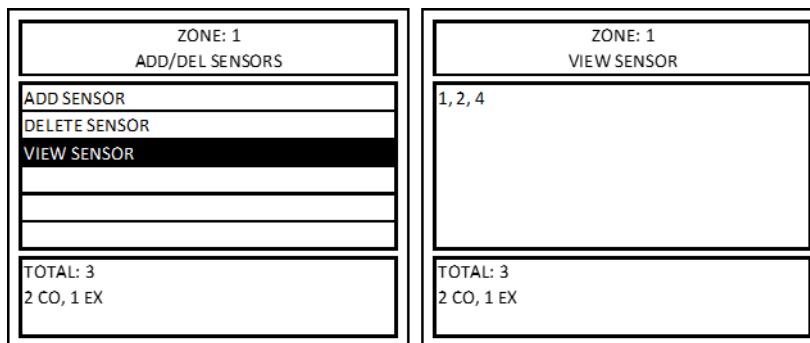

Figure 4-15 –

4.6.2.2 RELAY(S)

Menu path: Main Menu-->CONFIGURE SYSTEM? -->MANUAL CONFIGURE? -->CONFIGURE ZONES? -->ADD/EDIT ZONES-->RELAY(S): -->

To add relays to a zone or delete relays assigned from a zone, select “RELAY(S):” from the zone configuration menu and press ENTER. Then, select ADD RELAY or DELETE RELAY as shown below. The bottom box of the display will show any relays assigned to the zone and will get updated as you make changes.

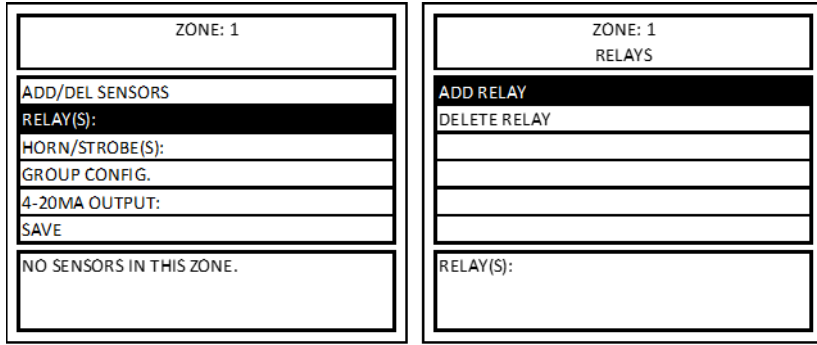

Figure 4-16 –

To assign a relay to the zone, select ADD RELAY and press ENTER. Input the relay number and press ENTER. The relay will be added to the zone and the display will return to the RELAYS menu with the bottom box of the display updated to reflect the changes made.

To delete a relay, select DELETE RELAY from the RELAYS menu and press ENTER. Input the relay number to delete and press ENTER (to delete all relays assigned to the zone, input “0” and press ENTER). The relay(s) will be deleted from the zone and the display will return to the RELAY menu with the bottom box of the display updated to reflect the change made.

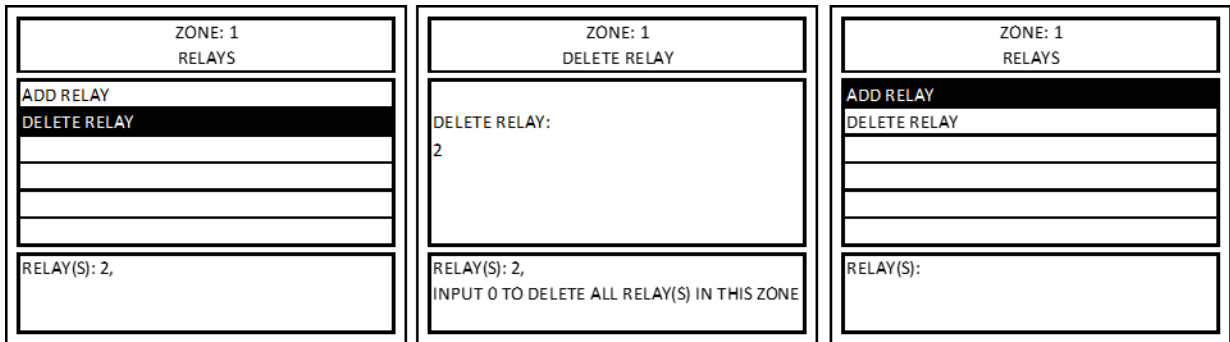

Figure 4-17 –

Relay assigned as Alarm Relay cannot be added to a zone. If an attempt to add an alarm relay to a zone is made, then it will display an error message “CANNOT ADD RELAY. DEDICATE FOR ALARM” as shown in Figure 4-18.

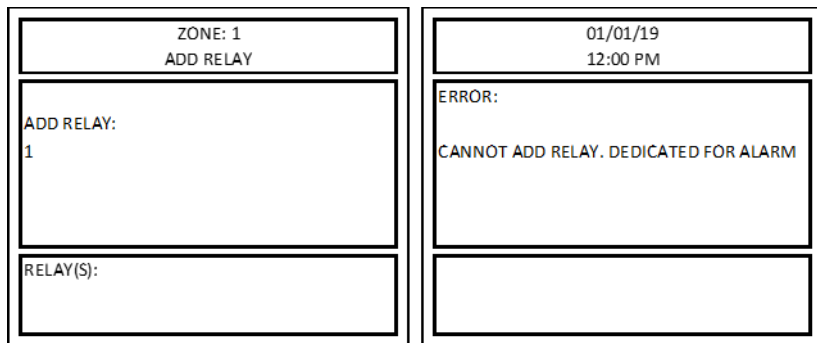

Figure 4-18 –

4.6.2.3 HORN/STROBE(S)

Menu path: Main Menu-->CONFIGURE SYSTEM? -->MANUAL CONFIGURE? -->CONFIGURE ZONES? -->ADD/EDIT ZONES-->HORN/STROBE(S): -->

To add Horn/Strobes to a zone or delete Horn/Strobes from a zone, select “HORN/STROBE(S)” from the zone configuration menu and press ENTER. Then, select ADD H/S or DELETE H/S. The bottom box of the display will display H/S assigned to the zone and will get updated as you make changes.

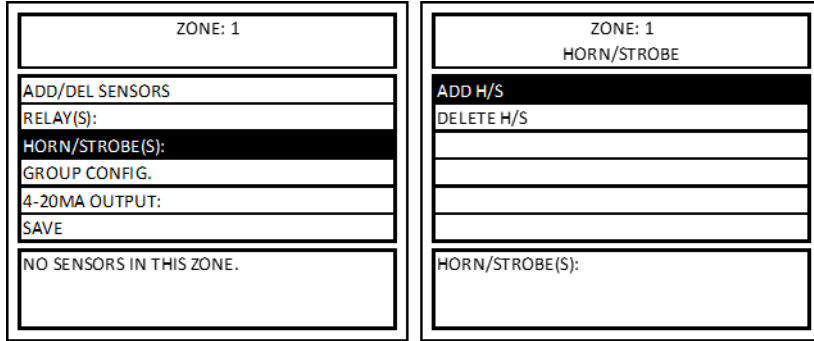

Figure 4-19 –

To assign a horn/strobe to the zone, select ADD H/S and press ENTER. Input the horn/strobe number (valid entries are 1 to 4) and press ENTER. The horn/strobe will be added to the zone and the display will return to the HORN/STROBE menu with the bottom box of the display updated to reflect the changes made (Refer Figure 4-20).

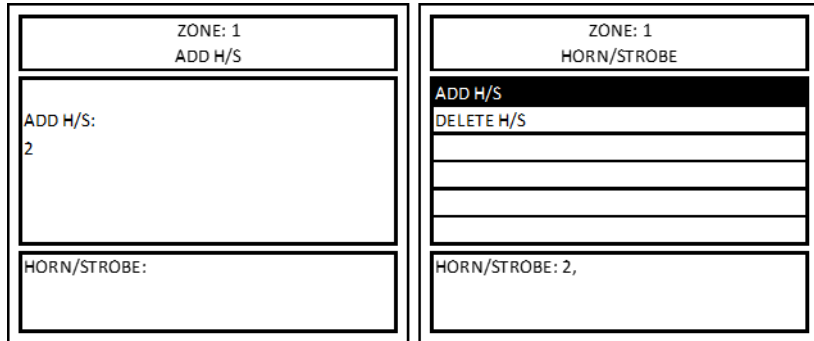

Figure 4-20 –

To delete a horn/strobe, select DELETE H/S from the HORN/STROBE menu and press ENTER. Input the horn/strobe number and press ENTER (to delete all horn/strobes assigned to the zone, input “0” and press ENTER). The horn/strobe(s) will be deleted from the zone and the display will return to the HORN/STROBE menu with the bottom box of the display updated to reflect the changes made.

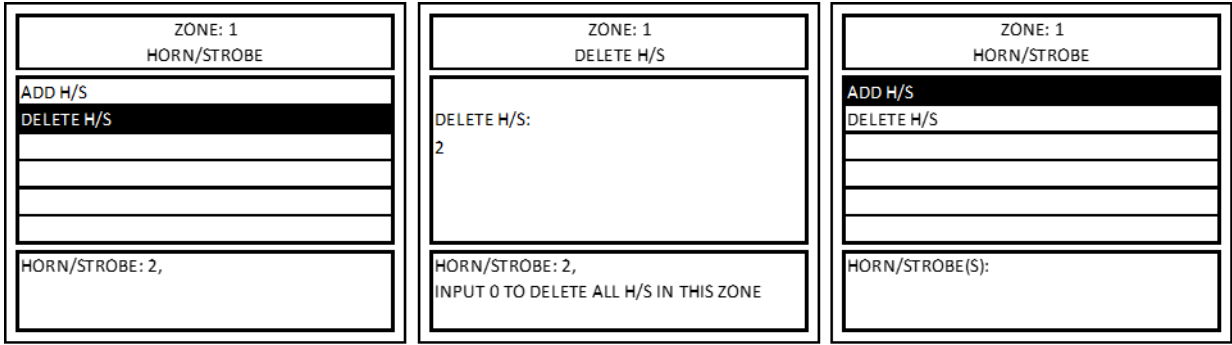

Figure 4-21 –

If a horn/strobe is already assigned as a dedicated alarm, warning, or trouble (see Section 4.6.1.2.2.3 CONFIGURE H/S), it will not be able to be added to the zone configuration and vice-versa. In the example below, H/S 1 has already been assigned as a dedicated alarm. Attempting to add it to the Zone 1 configuration results in an error message. Similarly, if a Horn/Strobe is assigned to a zone then it cannot be assigned to alarm, warning, or trouble.

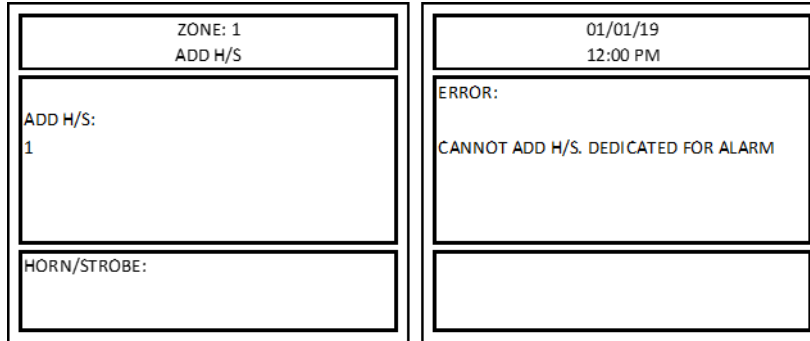

Figure 4-22 –

4.6.2.4 GROUP CONFIG.

Menu path: Main Menu-->CONFIGURE SYSTEM? -->MANUAL CONFIGURE? -->CONFIGURE ZONES? -->ADD/EDIT ZONES-->GROUP CONFIG. -->

Each group of sensors can be configured with settings unique to each zone.

For example, Group 1 sensors (CO gas) ALARM could be set to 200ppm in Zone 1 and 100ppm in Zone 2.

To configure the sensor groups within each zone, select GROUP CONFIG. from the zone configuration menu and press ENTER. To view or change values for a sensor type, select SENSOR TYPE and press ENTER.

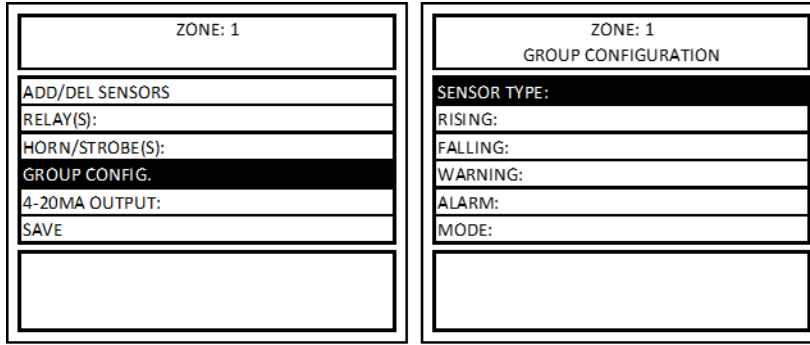

Figure 4-23 –

Then, enter the valid sensor type (displayed in bottom box) of the group to view and press ENTER. Once a valid sensor type has been entered, the current values for that sensor type or group of sensors in that zone will be displayed as shown below. To change the values, select the menu item and press ENTER. Then, key in the new value and press ENTER. For NO2 and O2 sensor press RIGHT key to add a decimal point after a value. E.g. to enter value 3.2, enter 3 press RIGHT key and then enter 2. Panel will display a message if an invalid value is entered. Values entered cannot be larger than range of the detector, rising value must be equal or greater than Falling value, and Alarm value must be equal or greater than Warning. Refer to Table 4-2 for default values for each field or menu item.

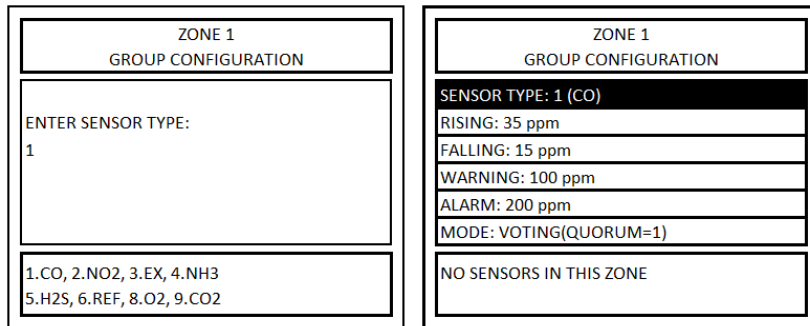

Figure 4-24 –

The following options are available for GROUP CONFIGURATION:

- RISING – If the gas concentration is greater than or equal to this level, the zone output(s) will be turned on.
- FALLING – If the gas concentration is less than or equal to this level, the zone output(s) will be turned off.
- WARNING - The gas concentration used to trigger a warning status for the group of sensors within the zone. Setting a warning level of 0 (zero) will disable warning detection for this sensor.
- ALARM – The gas concentration used to trigger an alarm status for the group of sensors within the zone. Setting an alarm level of 0 (zero) will disable alarm detection for this sensor.
- MODE – When multiple sensors are being monitored by a group, the output decision can be based on either voting, or the average of all sensors in the group. Valid modes are AVERAGE or VOTING (default). The bottom box in the LCD displays the current Mode used for the group (or sensor type).
 - AVERAGE: The gas concentrations from all sensors (of same type) in the group in a zone are averaged and
 - If the average is greater than or equal to the rising trip point, the zone outputs(s) are activated.
 - If the average is less than or equal to the falling trip point, the zone output(s) are de-activated.
 - If the average is between the two trip points, the outputs remain in their previous state.

- VOTING: The number of sensors (of same type) in the group indicating a value greater than or equal to the rising trip point is counted.
 - If the count is greater than or equal to the QUORUM, then the zone output(s) are activated.
 - For zone outputs to be deactivated first the count of sensors (of same type) with value greater than or equal to the rising trip point should be less than quorum value and count of sensors (of same type) with value less than or equal to the falling trip point should be greater than or equal to the quorum. NOTE: Activating the output(s) is given priority if there is an equal number of sensors (of same type) with gas readings greater than or equal to the rising trip point and sensors (of same type) with readings less than or equal to the falling trip point.
 - QUORUM: It is up to the installer to ensure that the quorum entry is appropriate for the configuration. A value greater than the number of sensors being monitored by the group, stops the group from controlling the outputs. The default quorum value is 1. Select Quorum and hit Enter after Selecting Voting to change the quorum to values other than default value of 1.

The default sensor types and settings are as follows:

Description	Carbon Monoxide	Nitrogen Dioxide	Combustible Gas	Ammonia	Hydrogen Sulfide	Refrigerants	Carbon Dioxide	Oxygen Depletion*	Oxygen Enrichment*
Type	CO	NO ₂	EX	NH ₃	H ₂ S	REF	CO ₂	O ₂	O ₂
Range	200 ppm	20 ppm	50% LEL	100 ppm	50 ppm	1,000 ppm	5,000 ppm	25% v/v	25.0% v/v
Alarm Level	200 ppm	5 ppm	20% LEL	75 ppm	20 ppm	300 ppm	4,000 ppm	19.5% v/v	23.5% v/v
Warning Level	100 ppm	2.5 ppm	15% LEL	50 ppm	15 ppm	200 ppm	1,500 ppm	20.0% v/v	22.5% v/v
Rising Level	35 ppm	2.5 ppm	10% LEL	25 ppm	8 ppm	100 ppm	1,000 ppm	20.3% v/v	22.0% v/v
Falling Level	15 ppm	1.2 ppm	5% LEL	10 ppm	3 ppm	50 ppm	800 ppm	20.6% v/v	21.5% v/v

Table 4-2 –

*The GROUP CONFIG. menu for Oxygen (SENSOR TYPE 8) has an additional option “O2 MODE” with available options: DEPLETION, ENHANCEMENT, BOTH. The Oxygen sensor can be configured to signal for:

1. High gas levels (ENHANCEMENT)
Values equal to or greater than 20.9%v/v are only valid for Enhancement settings (Rising, Falling, Warning and Alarm).
2. Low gas levels (DEPLETION)
Values equal to or less than 20.9%v/v are only valid for Depletion settings (Rising, Falling, Warning and Alarm).
3. High and low gas levels (BOTH)

If “BOTH” is selected for O2 mode, then panel will signal alarm, warning or zone activation for both oxygen depletion and enhancement. E.g. with default settings as indicated in Table 4-2 panel will indicate alarm condition for oxygen sensor reading of less than or equal to 19.5% vol as well as reading greater than or equal to 23.5% vol if “BOTH” is selected for O2 Mode. Whereas if “DEPLETION” mode is selected then panel will indicate alarm condition for reading less than or equal to 19.5% vol only and similarly if “ENHANCEMENT” mode is selected then panel will indicate alarm condition for reading greater than or equal to 23.5% vol only.

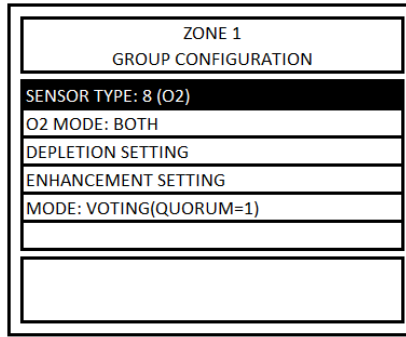

Figure 4-26 –

4.6.2.5 4-20mA OUTPUT or Analog Output

Menu path: Main Menu-->CONFIGURE SYSTEM? -->MANUAL CONFIGURE? -->CONFIGURE ZONES? -->ADD/EDIT ZONES-->4-20MA OUTPUT: -->

To assign 4-20mA output to a zone, select “4-20MA OUTPUT:” from the zone configuration menu and press ENTER. Then select “OUTPUT NUMBER:” and press ENTER.

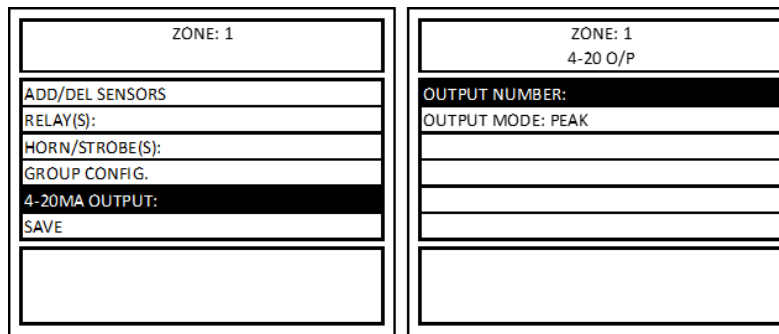

Figure 4-27 –

Input the 4-20mA output number to assign it to the zone. Valid entries are 1, 2 and 3 and press ENTER. The display will return to the 4-20 O/P menu screen and show the currently assigned 4-20 mA output in the OUTPUT NUMBER field.

NOTE: A zone can be assigned only one 4-20mA output, and a 4-20mA output can only be assigned to one zone. 4-20mA output once assigned to a zone can be re-assigned to a different zone but cannot be deleted from the zone.

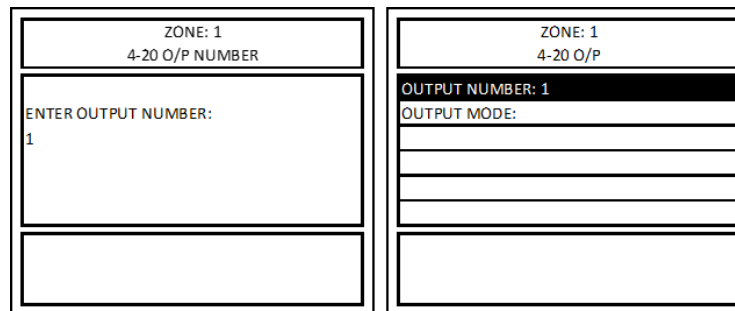

Figure 4-28 –

NOTE: Oxygen sensor readings is an exclusion for 4-20mA output i.e. its reading is not considered while computing output value for 4-20mA output.

Next, the output mode can be set to PEAK or SCALE.

PEAK – In this mode the gas reading active in the zone (except for the oxygen) corresponding to highest mA output is used to control the analog output assigned to the specific zone. In this case, any active gas reading, that is part of the zone will be taken in consideration, and the sensor reading corresponding to highest mA output will be used to control the analog output. E.g. If a CO and NO2 sensor is assigned to a zone and CO Sensor reading is 50ppm (which corresponds to 8mA) and NO2 sensor reading is 10.0ppm (which corresponds to 12mA) then 4-20mA or Analog output assigned to the zone will output 12mA.

SCALE – In this mode, the 4-20mA value for all detectors added to a zone are computed (for all sensor types except oxygen), and the output is the average of the 4-20mA value for all detectors assigned to the zone. E.g. If a CO and NO2 sensor is assigned to a zone and CO Sensor reading is 50ppm (which corresponds to 8mA) and NO2 sensor reading is 10.0ppm (which corresponds to 12mA) then 4-20mA or Analog output assigned to the zone will output 10mA.

To select the output mode for 4-20mA output, select OUTPUT MODE from the 4-20 O/P menu and press ENTER. Then, select PEAK or SCALE from the 4-20 O/P MODE menu and press ENTER. The display will return to the 4-20 O/P menu and the output mode selection will be updated as shown in Figure 4-29.

When the status of the zone is TROUBLE then 4-20mA output assigned to corresponding zone will switch the output to 20mA.

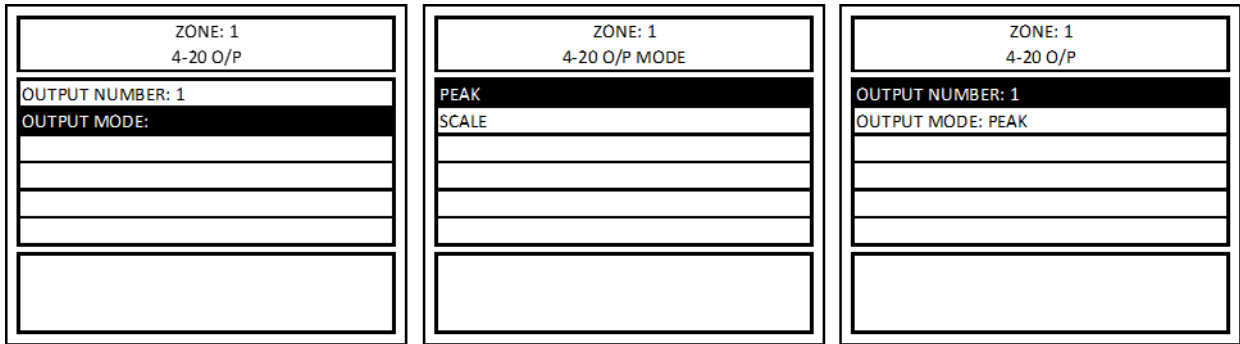

Figure 4-29 –

4.6.3 CONFIGURE RELAYS, H/S, BUZZER?

Menu path: Main Menu-->CONFIGURE SYSTEM? -->MANUAL CONFIGURE? -->CONFIGURE RELAYS, H/S, BUZZER? -->

The DVP-1200 includes 4 standard onboard relays with the option to add an additional 4 onboard relays. Additionally, remote relays can be added to the system. It also has an onboard buzzer and includes 4 outputs designed to operate standalone horn/strobe units. This section includes directions to configure those components.

From the CONFIGURE SYSTEM menu, select CONFIGURE RELAYS, H/S, BUZZER? and press ENTER. The display will show the CONFIGURE RELAYS, H/S, BUZZER? menu as shown in the images below.

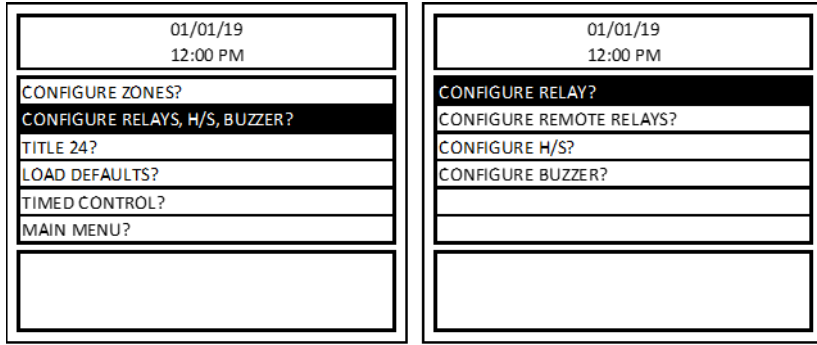

Figure 4-30 –

4.6.3.1 CONFIGURE RELAY?

Menu path: Main Menu-->CONFIGURE SYSTEM? -->MANUAL CONFIGURE? -->CONFIGURE RELAYS, H/S, BUZZER? -->CONFIGURE RELAY? -->

To configure an onboard relay, follow the menu sequence as shown in Figure 4–30. With “RELAY:” selected, press ENTER.

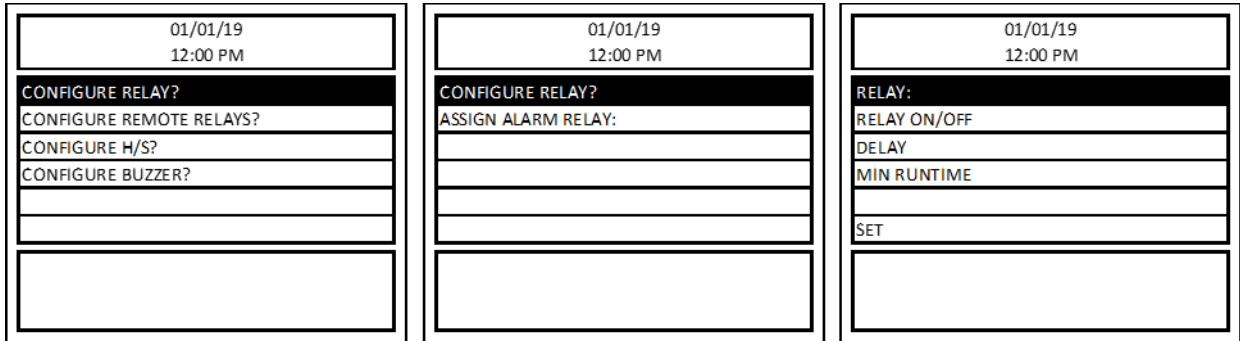

Figure 4-31 –

Then, input the relay number to configure and press ENTER. The current relay configuration will be loaded and become editable as shown in Figure 4–32.

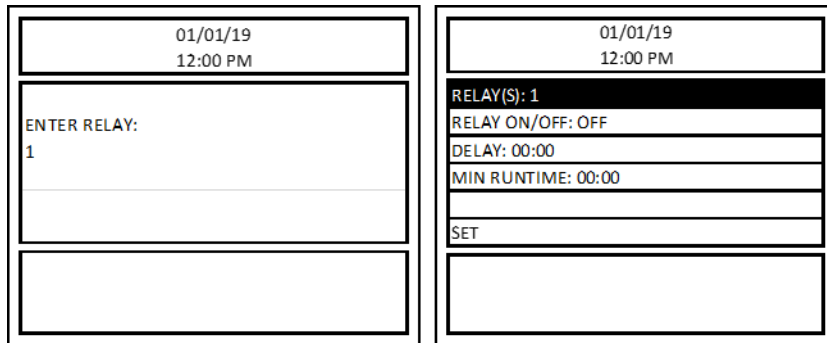

Figure 4-32 –

The following options are available for relay configuration:

- RELAY – Select the relay number to view settings and make changes.
- RELAY ON/OFF – Sets the selected relay to normally closed (ON) or normally open (OFF). Default value for this setting is OFF. Highlight this sub-menu and press Enter to change this configuration. Fail Safe operation can be implemented by configuring a relay to operate Normally ON, and wiring the circuit using the NC (normally closed) contact. In this way, if the control panel loses power the relay will activate the controlled device if it still has power.
- DELAY – Sets a delay between when conditions to activate the relay occur and when the relay activates. The time format is: [mm: ss]. Default delay time is 00:00. Highlight this sub-menu and press Enter to enter delay for the selected relay.
- MIN RUNTIME – Sets the minimum runtime once a relay is activated. The time format is: [mm: ss]. Default value is 00:00. Highlight this sub-menu and press Enter to enter minimum run time value for the selected relay.
- SET – The user must select SET to save the changes. The changes will become active as soon as the user selects SET.

ASSIGN ALARM RELAY

The user can assign a single relay to activate when an alarm condition occurs (regardless of zone). A relay assigned to ALARM will be dedicated to ALARM only and will not be shared with zones.

To assign a relay to ALARM, follow the menu as shown in Figure X. If any of the relay was assigned for Alarm, then it would be displayed in sub-menu “ASSIGN ALARM RELAY:”.

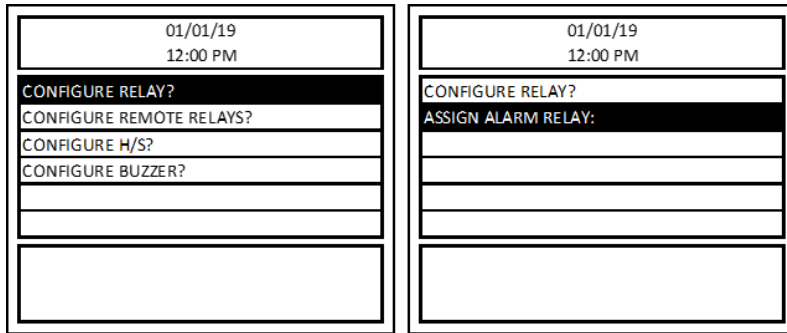

Figure 4-33 –

In the example below, relay 1 is assigned for the ALARM relay. After pressing ENTER, the display shows confirmation of the relay status. Enter “0” to set no relay as the alarm relay.

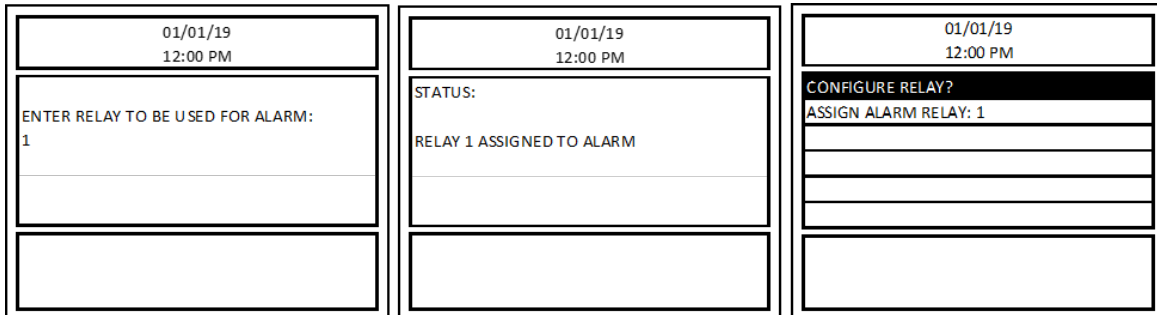

Figure 4-34 –

4.6.3.2 CONFIGURE REMOTE RELAYS

Menu path: Main Menu-->CONFIGURE SYSTEM? -->MANUAL CONFIGURE? -->CONFIGURE RELAYS, H/S, BUZZER? -->CONFIGURE REMOTE RELAYS?

To configure remote relays, follow the menu as shown in the images below. The user must first select DISCOVER REMOTE RELAYS before ASSIGN AND CONFIGURE REMOTE RELAYS becomes selectable.

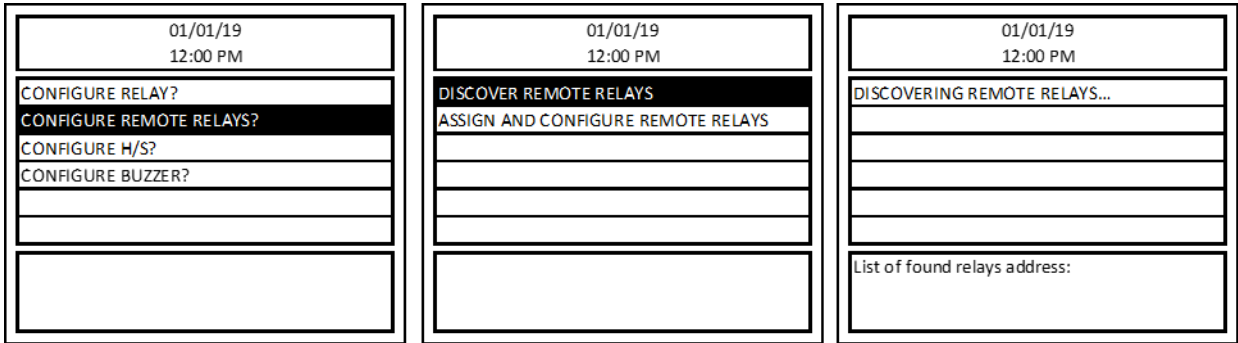

Figure 4-35 –

Once the system has found remote relay, the screen shown in Figure 4-36 below will be display with address of remote relay. If DVP-1200 does not find any remote relay, then it will display NO RELAY FOUND in bottom box of the LCD. In this case it is recommended to verify the communication settings for Remote Relay in DVP-1200 matches with RR-24 unit in addition to verifying the wiring between RR-24 and DVP-1200.

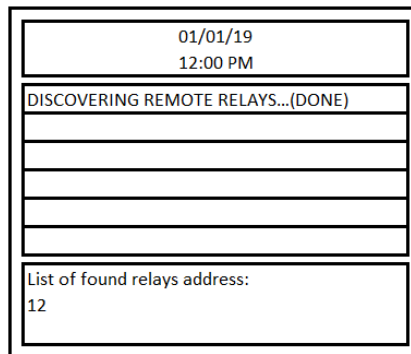

Figure 4-36 –

After successful remote relay discovery, next step is to assign and configure remote relay. Relays 9 to 12 in DVP-1200 are reserved for remoted relays. Odd number relay (9 and 11) correspond to Relay 1 of the remote relay (RR-24) and even number relay (10 and 12) correspond to Relay 2 of the remote relay (RR-24). Remote relays can only be assigned to continuous relay number i.e. a remote relay can be assigned either Relay 9 and 10 or Relay 11 and 12. If only one remote relay is connected, then DVP-1200 will only allow to assign the connected remote relay to Relay 9 and 10. Follow the menu sequence as shown below to assign remote relay.

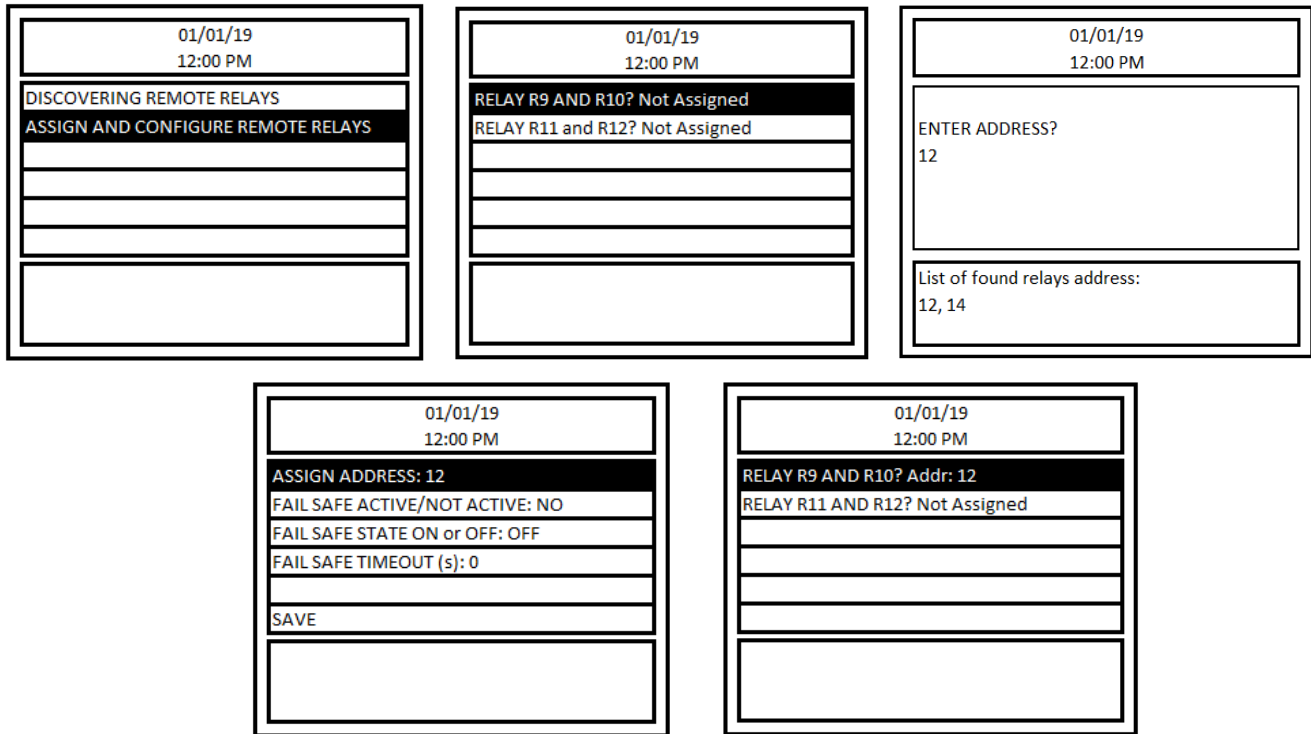

Figure 4-37 –

Following additional fail-safe settings are available for Remote Relay Configuration.

- **FAIL SAFE ACTIVE/NOT ACTIVE**
With this setting one can either enable (FAIL SAFE ACTIVE) or disable (FAIL SAFE NOT ACTIVE) fail safe operation for corresponding remote relay.
- **FAIL SAFE STATE ON or OFF**
This setting defines the state of the relay during fail safe condition if fail-safe settings is active or enabled.
- **FAIL SAFE TIMEOUT (s)**
This is the time (in seconds) that the remote relay must wait for communication from the DVP-1200 before going into fail-safe mode if fail-safe setting is active (ON). Valid entries are 10 to 3600 seconds.

To change corresponding setting, highlight the line and hit Enter. Select the desired settings and hit Enter again. Once the desired configuration is selected for all fail-safe settings hit SAVE to save the settings and transfer the settings to remote relay. Repeat the assignment procedure for second remote relay.

To configure Relays 9 to 12 for regular settings (delay, minimum run time etc.) use CONFIGURE RELAY? menu. Once remote relay is discovered and assigned then only corresponding relay number (9,10,11 and 12) will be valid entries for CONFIGURE RELAY menu.

4.6.3.3 CONFIGURE H/S

Menu path: Main Menu-->CONFIGURE SYSTEM? -->MANUAL CONFIGURE? -->CONFIGURE RELAYS, H/S, BUZZER? -->CONFIGURE H/S?

To configure a horn/strobe, follow the menu as shown in the images below. With “HORN/STROBE(S):” selected, press ENTER. Then input the horn/strobe number to configure (H/S 1 is shown in the example below) and press ENTER.

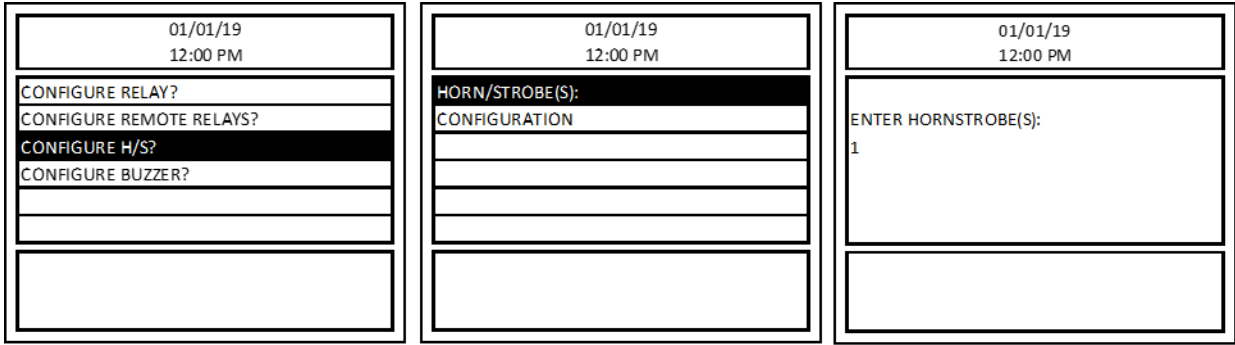

Figure 4-38 –

Select CONFIGURATION and press ENTER. The current configuration for the selected horn/strobe will load and become editable as shown in the images below.

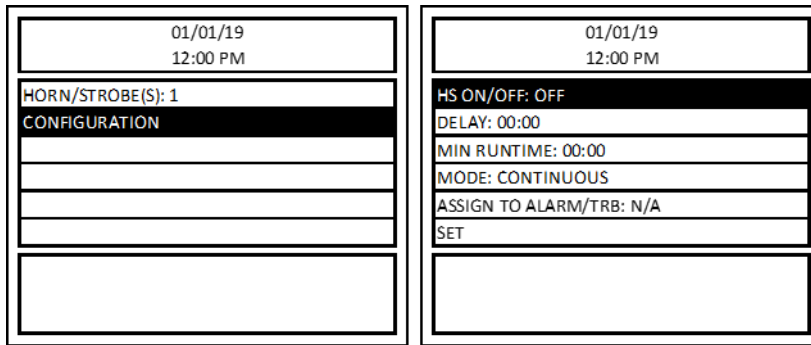

Figure 4-39 –

The following options are available for horn/strobe configuration:

- HS ON/OFF – Sets the selected Horn/Strobe to normally closed (ON) or normally open (OFF). Default value for this setting is OFF.
- DELAY – Sets a delay between when conditions to trigger the horn/strobe occur and when the horn/strobe turns on. The time format is: [mm: ss]. The default delay time is 00:00. To set the delay for the selected horn/strobe, highlight this sub-menu and press Enter.
- MIN RUNTIME – Sets the minimum runtime once a horn/strobe is activated. The time format is: [mm: ss]. The default minimum runtime is 00:00. To set the minimum runtime for the selected horn/strobe, highlight this sub-menu and press Enter. A horn would not normally require a minimum on time, but this parameter allows a more versatile configuration.
- MODE – The horn/strobe MODE can be set to CONTINUOUS(DEFAULT) or INTERMITTENT.
- ASSIGN TO ALARM/TRB – The horn/strobe can be assigned to activate during an ALARM, WARNING, or TROUBLE condition (regardless of zone). The default setting is NOT ASSIGNED(DEFAULT).
NOTE: A horn/strobe assigned to ALARM/WARNING/TROUBLE will be dedicated to that function and will not be able to be assigned to a zone.
- SET – The user must select SET to save the changes. The changes will become active as soon as the user selects SET.

4.6.3.4 CONFIGURE BUZZER

Menu path: Main Menu-->CONFIGURE SYSTEM? -->MANUAL CONFIGURE? -->CONFIGURE RELAYS, H/S, BUZZER? -->CONFIGURE BUZZER

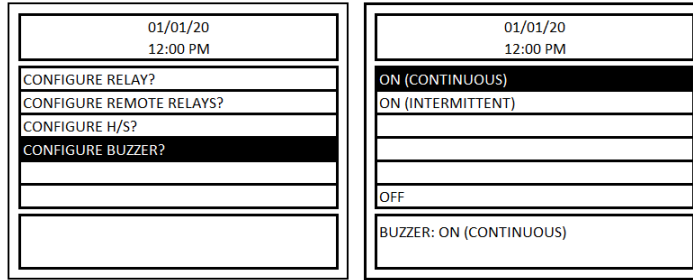

Figure 4-40 –

The DVP-1200 includes an onboard buzzer. The buzzer will activate during an ALARM, WARNING or TROUBLE condition. If the buzzer is activated, the user can press the HUSH button to silence it.

To configure the onboard buzzer, follow the menu as shown in Figure 4-37. Select CONFIGURE BUZZER? and press ENTER. The display will show the buzzer configuration options. It will also show the current buzzer configuration in the bottom box of the display.

The following options are available for the buzzer configuration:

- ON (CONTINUOUS) –During an ALARM, WARNING or TROUBLE condition, the buzzer will activate continuously. This is the default setting.
- ON (INTERMITTENT) – During an ALARM, WARNING or TROUBLE condition, the buzzer will activate intermittently (1 second on, 1 second off).
- OFF – This configuration will disable the functionality of buzzer and buzzer will not activate during any ALARM, WARNING or TROUBLE conditions.

4.6.3.5 LOAD DEFAULTS?

Menu path: Main Menu-->CONFIGURE SYSTEM? -->MANUAL CONFIGURE? -->LOAD DEFAULTS? -->

WARNING: This option will reset the DVP-1200 to its default factory settings. All zones and configuration will be lost.

To reset the DVP-1200 to its default factory settings, select LOAD DEFAULTS? from the CONFIGURE SYSTEM menu and press ENTER. Then press ENTER again. The configuration will be reset to factory settings and the DVP-1200 will restart.

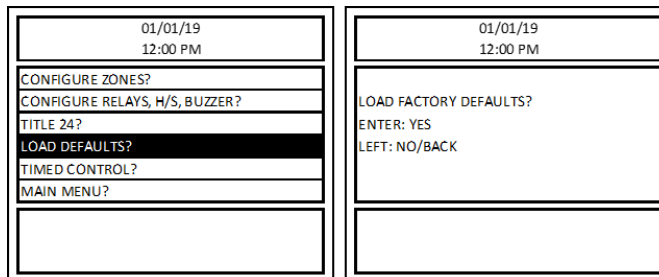

Figure 4-41 –

4.6.3.6 *TIMED CONTROL?*

Menu path: Main Menu-->CONFIGURE SYSTEM? -->MANUAL CONFIGURE? -->TIMED CONTROL? -->

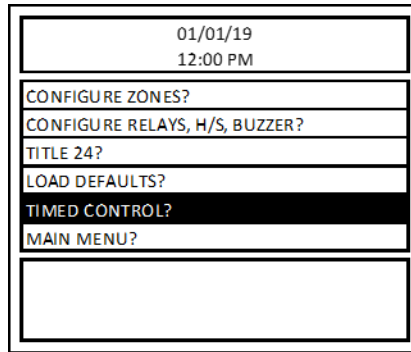

Figure 4-42 –

TIMED CONTROL can be used to turn the zone’s output ON at the START TIME and OFF at the next occurrence of STOP TIME irrespective of readings of sensors assigned to the zone. Timed control can be configured with separate time periods for weekdays and weekends. A zone must be created first (via Zone Configuration menu) before using TIMED MODE for the zone.

To setup timed control, select TIMED CONTROL from the configuration menu and press ENTER. Then select ZONE: and press ENTER. Enter the zone number to configure and press ENTER. Select CONFIGURE and press ENTER to enter the TIMED CONTROL menu.

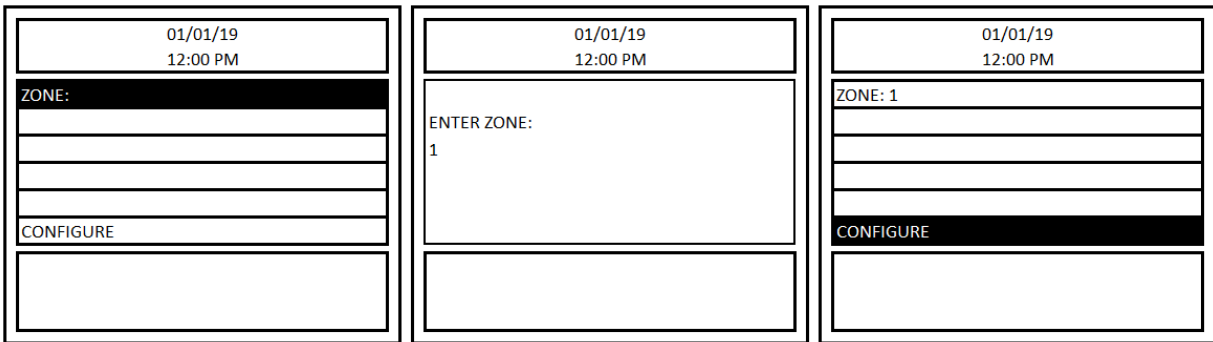

Figure 4-43 –

The display will show the following TIMED CONTROL menu:

01/01/19 12:00 PM
DAYS:
START TIME:
STOP TIME:
ACTIVE: OFF
SAVE

Figure 4-44 –

DAYS – Choose whether to configure weekdays or weekends. Select DAYS and press ENTER. Then, to set a schedule for WEEKDAY, press 1, then ENTER. To set a schedule for WEEKEND, press 2, then ENTER.

01/01/19 12:00 PM	01/01/19 12:00 PM	01/01/19 12:00 PM
DAYS:	ENTER 1:WEEKDAY, 2:WEEKEND	DAYS: WEEKDAY
START TIME:	1	START TIME:
STOP TIME:		STOP TIME:
ACTIVE: OFF		ACTIVE: OFF
SAVE		SAVE

Figure 4-45 –

START TIME – start of the time period for this zone. To enter the START TIME, use the left and right arrows to select the digit and the number pad to enter the value. To toggle between AM and PM, use the up and down arrows.

01/01/19 12:00 PM
ENTER TIME:
00:00 AM

Figure 4-46 –

END TIME – End of the time period for this zone. To enter the END TIME, use the left and right arrows to select the digit and the number pad to enter the value. To toggle between AM and PM, use the up and down arrows.

NOTE: START TIME and END TIME are entered in 12-hour time format, only entries with START TIME earlier than END TIME are valid. E.g. 11:00 AM (Start Time) to 01:00PM (End Time) is a valid entry but 11:00PM (Start Time) to 01:00 AM (End Time) is an invalid entry.

ACTIVE – Timed Mode Control will work only when this field is set to ON. The default setting is OFF. The user can disable the TIMED MODE for the chosen zone by setting ACTIVE: OFF.

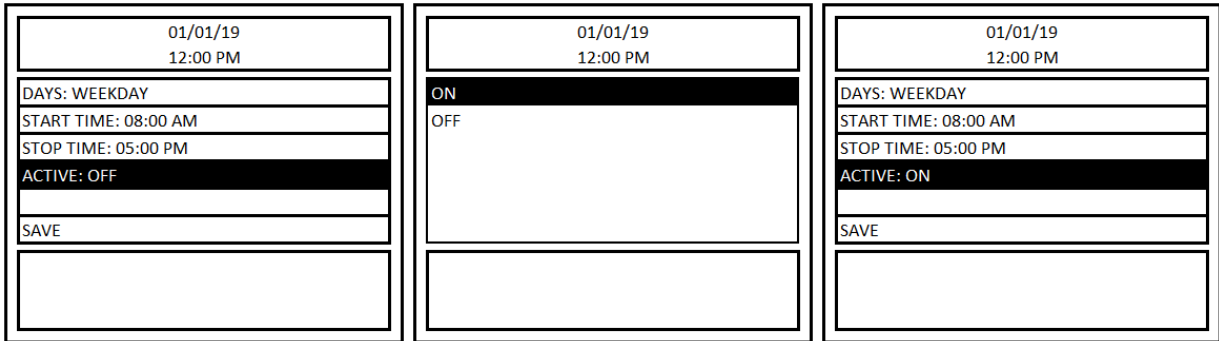

Figure 4-47 –

SAVE – Select SAVE and press ENTER to save any changes.

4.6.4 COMMUNICATION?

Menu path: Main Menu-->COMMUNICATION?-->

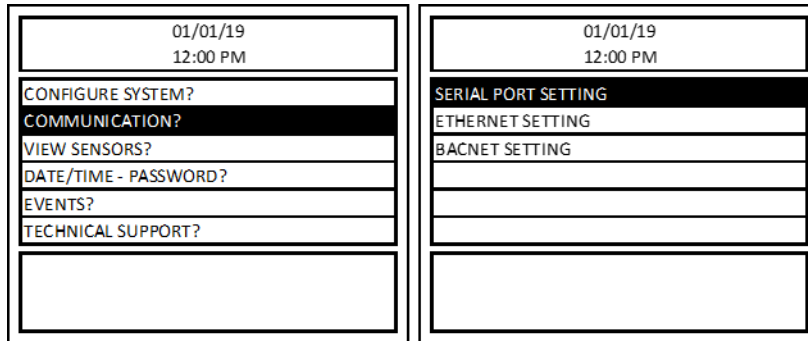

Figure 4-48 –

4.6.4.1 SERIAL PORT SETTING

Menu path: Main Menu-->COMMUNICATION? -->SERIAL PORT SETTING-->

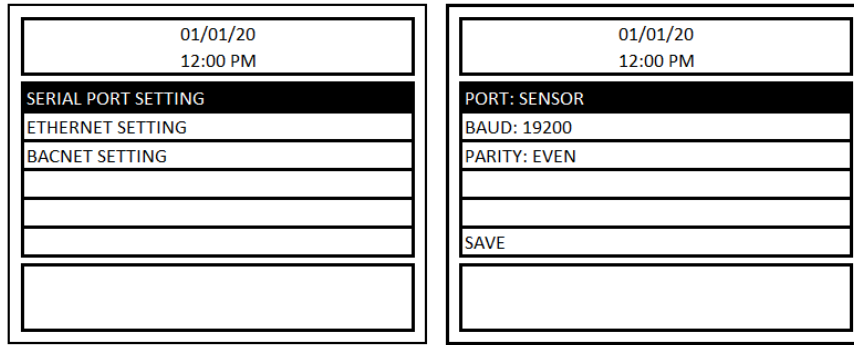

Figure 4-49 –

Communication settings of the panel for communicating with sensors and remote relay connected can be configured via this setting.

PORT – Select the port to configure. Available options are SENSOR or REMOTE RELAY.

BAUD – The user can change the baud rate for communication with the detector using this menu. Available rates are: 4800, 9600, 19200 (default), 38400, 57600, 115200.

PARITY: – Available options are EVEN, ODD, OFF.

SAVE– To save changes select SAVE and press ENTER.

4.6.4.2 ETHERNET SETTING

Menu path: Main Menu-->COMMUNICATION? -->ETHERNET SETTING-->

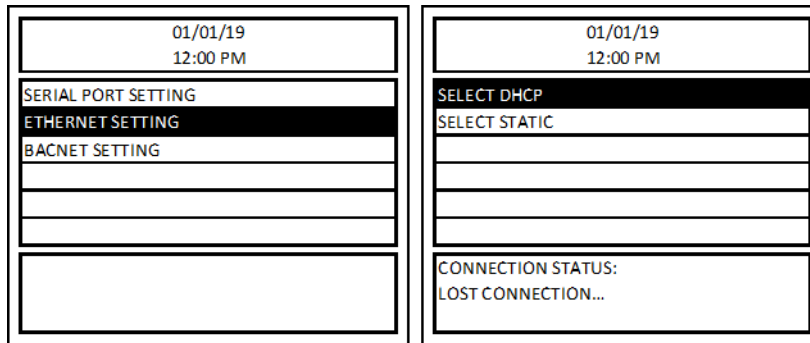

Figure 4-50 –

SELECT DHCP – The DHCP setting will allow a connected router to automatically configure the ethernet connection to the DVP-1200.

SELECT STATIC – The static setting allows the user to configure the ethernet connection manually.

- IP ADDRESS: 0.0.0.0
- SUBNET MASK: 0.0.0.0
- GATEWAY: 0.0.0.0

4.6.4.3 BACNET SETTING

Menu path: Main Menu-->COMMUNICATION? -->BACNET SETTING-->

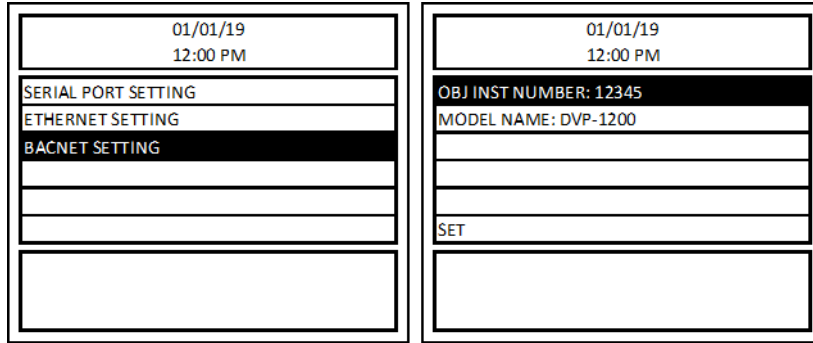

Figure 4-51 –

- OBJ INST NUMBER: Number in range 0 to 65535 are valid entries for Panel BACnet Object Instant Number.
- MODEL NAME: Model name entered in this field will appear as device name for the panel in BACnet network.

4.6.5 VIEW SENSORS?

Menu path: Main Menu-->VIEW SENSORS-->

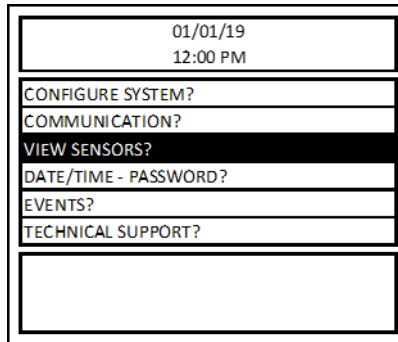

Figure 4-52 –

The VIEW SENSORS menu allows the user to view information about the sensors connected to the DVP-1200. Press the left/right cursor to scroll through the sensors. To select a specific sensor without scrolling, select “Sensor: x” and press ENTER. Then, enter the sensor address and press ENTER.

Sensor Description: Each sensor can be given a user defined description. The description is often used to describe the sensor’s location. To add or change a sensor’s description, select Sensor Description and press ENTER. A screen with sensor address, DESCRIPTION and SAVE will appear. Select ‘DESCRIPTION’ and hit ENTER. Then, use the alphanumeric keys to enter the description and press ENTER. Sensor description is limited to 20 characters. Use RIGHT arrow key to move to next character or to add a space and use DEL to delete last character entered. Once desired description is entered, SAVE the sensor description. Sensor Description entered for each sensor will be displayed in ALARM, WARNING and TROUBLE screen if corresponding sensor is one of the sources for the ALARM, WARNING or TROUBLE signal.

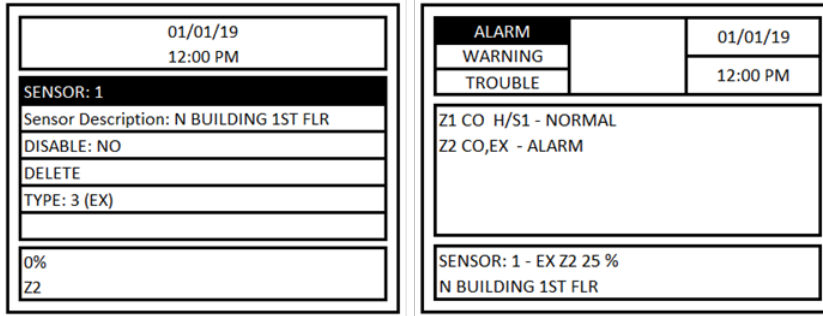

Figure 4-53 –

Disable: No - If any sensor is disabled, the panel will not take the sensor readings into consideration for Zone Outputs activation, panel fault conditions, etc. This is like a virtual delete.

When a sensor previously disabled is enabled back, then all the functionality related to the sensor is resumed back, i.e. sensor readings will be taken into consideration for Zone Outputs activation, panel fault conditions, etc.

This option allows the user to disconnect a sensor for repair or replacement without any trouble or error at the panel. For example, to replace a sensor, first disable that specific sensor in the panel. Then, disconnect it from the system and replace it with the new unit (of same type). Lastly, return to the VIEW SENSORS menu and enable the sensor. Using this method, all previous sensor configurations will be retained so it will not be necessary to reconfigure the sensor.

Delete – This will delete the sensor from the panel and from all the zone to which the sensor is added.

If the sensor is connected to the panel even after deleting it, then the panel must discover the sensor again. However, it will be like a new sensor discovery. Therefore, the sensor will not be added to any zones.

Note: When replacing a sensor (already registered with DVP-1200) with a sensor of different type but same address(e.g. CO sensor with address 17 replaced with NO2 sensor with address 17) then it is recommended to perform a Delete operation for corresponding sensor address, after sensor replacement is complete, and verify correct sensor type is displayed for corresponding sensor address.

Type: - Displays the sensor type. See Table 4-2 for a definition of each type.

The bottom box of the display shows the current gas reading of the detector. It also lists any zones the detector is part of. E.g. In following example, Sensor 1 is CO Sensor (Type: 1) reading 0ppm and is currently assigned to Zone 1.

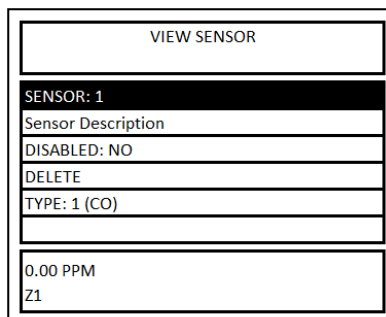

Figure 4-54 –

4.6.6 DATE/TIME – PASSWORD?

Menu path: Main Menu-->DATE/TIME – PASSWORD? -->

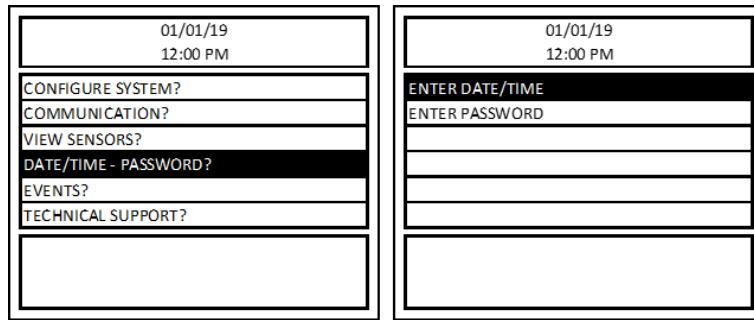

Figure 4-55 –

ENTER DATE/TIME – For the date and time, use the left/right keys to select the digit and the number keys to input a value. For the day of the week, select the field and use the up/down keys to scroll through days of the week. Time is entered in 12-hour format. To edit AM or PM, select the field and use up/down keys to toggle between AM and PM.

ENTER PASSWORD – This menu is used to enter a new password for the panel. Enter up to a 4-digit new password and hit ENTER to save the new password.

4.6.7 EVENTS?

Menu path: Main Menu-->EVENTS? -->

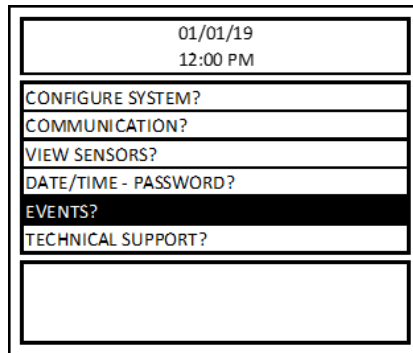

Figure 4-56 –

The DVP-1200 keeps a log of events in its memory. To view the events, select EVENTS? and press ENTER. The display will load the latest logged events if this menu is entered first time after power up otherwise it will load event screen last visited. It can store up to 122,880 events and once this limit is reached it will start overwriting older events.

Power Up, Alarm, Warning, Trouble and Relay activation are types of events that are logged in the panel. All the logged events will have date and time of the event occurrence. For Trouble, Alarm and Warning the event log will also have the sensor address that caused the corresponding event. Alarm and Warning events for a sensor are logged only if they are assigned to a zone. Figure 4-57 shows an example of Event Log screen and Table X lists the abbreviations used in Event Log for corresponding events.

EVENT	ABBREVIATION
Alarm	ALM
Warning	WARN
Relay Activation	RLY OP

Table 4-3 – Event Log Abbreviations

02/27/20 10:23 AM
POWER UP 02/03/20 02:59PM
TROUBLE 02/03/20 03:05PM #14 CO SNSR BRK
RLY OP 02/23/20 03:52PM G1 Z5 R3,R5,R9
WARN 02/23/20 03:52PM #13 CO Z1 100 ppm
WARN 02/23/20 03:52PM #14 CO Z3 100 ppm
TROUBLE 02/25/20 04:07PM #14 CO DISC.
SHOWING EVENTS FROM 90 TO 95 NUMBER EVENTS LOGGED IN MEMORY: 487

Figure 4-57 – Event Log Screen

Event Log screen also shows current displayed event number starting from top (events are logged in chronological order i.e. last event is the last entry in event log) and total number of events logged so far. Use the up and down arrow keys to scroll through past events. Press LEFT arrow key to exit Event Log screen. To delete all events from memory, from the event log screen press DEL. Then, press “0” followed by ENTER.

4.6.8 TECHNICAL SUPPORT?

Menu path: Main Menu-->TECHNICAL SUPPORT? -->

01/01/19 12:00 PM	01/01/19 12:00 PM
CONFIGURE SYSTEM?	COMPANY
COMMUNICATION?	PHONE:
VIEW SENSORS?	MACURCO TECH SUPPORT
DATE/TIME - PASSWORD?	844-325-3050
EVENTS?	SUPPORT@MACURCO.COM
TECHNICAL SUPPORT?	WWW.MACURCO.COM
	VERSION: 0.32 - SERIAL# 1234

Figure 4-58 –

The TECHNICAL SUPPORT? menu item shows the contact information for Macurco technical support. It also displays the currently installed firmware version and the serial number of the DVP-1200. If the Company Information and Phone Number of the installation company was entered during initial power up, then it will be displayed in this screen. This information (COMPANY and PHONE) can be entered or edited by pressing ENTER in the TECHICAL SUPPORT screen.

5 BACnet

5.1 General Information

Following information about DVP-1200 are accessible via BACnet.

1. Group Settings (Range, Alarm, Warning, Rising, Falling) for each type of sensor for all Zones.
2. Readings and Type for all detectors
3. Zone Configurations (Types of detectors assigned, Horn/Strobe Assigned, Relay Assigned, Analog Output Assigned, Quorum for Voting Mode) for all Zones
4. Output status and values of DVP-1200 Outputs

Note: BACnet Objects with value 65535 indicates the value received is not reliable. Some of the possible reasons for such a high value received are sensor not connected to panel, sensor is in trouble, or invalid/not supported BACnet object. Operator must figure out the root cause of such readings.

For details on BACnet implementation or BACnet capabilities of DVP-1200, refer to DVP-1200 PICS available in product page in company website (www.macurco.com).

1. Group Settings for each type of sensor for all Zones

Information about Group Settings for each gas type can be accessed via BACnet output in DVP-1200. Table 5-3 shows the BACnet Object Type and Object Instance for each object. N in Table 5-3 refers to zone number. E.g. if I want to access the Alarm settings for CO sensor in Zone 3, then Object Instance for the corresponding object is $3 + (3-1) * 68 = 139$.

Group settings are local to zone and hence each zone can have different settings for same type of sensor. Table 5-1 shows the possible values for ‘code’ object and corresponding detector type. Similarly, Table 5-2 shows the possible values for ‘Eng.unit’ object and corresponding engineering unit.

Code (Type)	Detector Type
1	CO (Carbon Monoxide)
2	NO ₂ (Nitrogen Dioxide)
3	EX (Combustible)
4	NH ₃ (Ammonia)
5	H ₂ S (Hydrogen Sulfide)
6	REF (Refrigerant)
8	O ₂ (Oxygen)
9	CO ₂ (Carbon Dioxide)

Table 5-1 – Types of Detector

Eng. Unit Value	Engineering Units
1	ppm
2	%LEL
3	%Vol.

Table 5-2 – Engineering Unit

Description		BACnet Object Type	BACnet Object Instance
Zone[N] N is from 1 to 8	Gas sensor [CO]	type	0+(N-1)*68
		Eng. unit	1+(N-1)*68
		range	2+(N-1)*68
		Alarm	3+(N-1)*68
		Warning	4+(N-1)*68
		Rising	5+(N-1)*68
		Falling	6+(N-1)*68
	Gas sensor [NO ₂]	type	7+(N-1)*68
		Eng. unit	8+(N-1)*68
		range	9+(N-1)*68
		Alarm	10+(N-1)*68
		Warning	11+(N-1)*68
		Rising	12+(N-1)*68
		Falling	13+(N-1)*68
	Gas sensor [EX]	type	14+(N-1)*68
		Eng. unit	15+(N-1)*68
		range	16+(N-1)*68
		Alarm	17+(N-1)*68
		Warning	18+(N-1)*68
		Rising	19+(N-1)*68
		Falling	20+(N-1)*68
	Gas sensor [NH ₃]	type	21+(N-1)*68
		Eng. unit	22+(N-1)*68
		range	23+(N-1)*68
		Alarm	24+(N-1)*68
		Warning	25+(N-1)*68
		Rising	26+(N-1)*68
		Falling	27+(N-1)*68
	Gas sensor [H ₂ S]	type	28+(N-1)*68
		Eng. unit	29+(N-1)*68
		range	30+(N-1)*68
		Alarm	31+(N-1)*68
		Warning	32+(N-1)*68
		Rising	33+(N-1)*68
		Falling	34+(N-1)*68
	Gas sensor [REF]	type	35+(N-1)*68
		Eng. unit	36+(N-1)*68
		range	37+(N-1)*68
		Alarm	38+(N-1)*68
		Warning	39+(N-1)*68
		Rising	40+(N-1)*68
		Falling	41+(N-1)*68
	Gas sensor [O ₂]	type	49+(N-1)*68
		Eng. unit	50+(N-1)*68
		range	51+(N-1)*68
		Alarm	52+(N-1)*68
		Warning	53+(N-1)*68

Description		BACnet Object Type	BACnet Object Instance	
		Rising	Analog value	$54+(N-1)*68$
		Falling	Analog value	$55+(N-1)*68$
		Alarm2	Analog value	$56+(N-1)*68$
		Warning2	Analog value	$57+(N-1)*68$
		Rising2	Analog value	$58+(N-1)*68$
		Falling 2	Analog value	$59+(N-1)*68$
		mode	Analog value	$60+(N-1)*68$
	Gas sensor [CO ₂]	type	Analog value	$61+(N-1)*68$
		Eng. unit	Analog value	$62+(N-1)*68$
		range	Analog value	$63+(N-1)*68$
		Alarm	Analog value	$64+(N-1)*68$
		Warning	Analog value	$65+(N-1)*68$
		Rising	Analog value	$66+(N-1)*68$
		Falling	Analog value	$67+(N-1)*68$

Table 5-3 – BACnet Objects for Group Settings of all Zone

2. Readings and Type for all detectors

Each sensor addresses from 1 to 192 has two BACnet Objects (one for sensor reading and one for sensor type referred as group). Table 5-4 shows the BACnet objects and corresponding object instance. N in Table 4 refers to the sensor address. E.g. to retrieve sensor reading for address 16, corresponding object instance is $553 + (16-1)*2 = 583$.

If a sensor address is not detected by the panel, then corresponding BACnet object reading and group value will be 65535 and 0, respectively.

Note: If the value of sensor reading BACnet object is outside the range of detection of the sensor then the reading is not reliable and cause for unreliable reading must be investigated. Refer to Table 4-2 or sensor manual for information on range of detection.

Description		BACnet Object Type	BACnet Object Instance	Notes
Sensors[N] Where N is from 1 to 192	reading	Analog value	$553+(N-1)*2$	e.g. To retrieve sensor # 16 reading, use $553+(16-1)*2 = 583$
	type	Analog value	$553+(N-1)*2+1$	

Table 5-4 – BACnet Object for Detector Reading

3. Zone Configurations (Types of detectors assigned, Horn/Strobe Assigned, Relay Assigned, Analog Output Assigned, Quorum for Voting Mode) for all Zones

Table 5-6 shows the BACnet Objects representing zone configuration for each zone. N in Table 5-6 refers Zone number.

When binary output is set to 1 (or active), it means that the corresponding DVP-1200 output (Horn/Strobe, Relay) is configured or assigned to that zone, or in case of the group[X] means that the sensor of type X (Table 5-1 lists the valid values of type i.e. value of X) is added to that zone.

If any of the three analog outputs are assigned to the zone, then object “analog output” for corresponding zone will have the analog output number (valid values are 1,2 and 3). If the zone does not have any analog (or 4-20mA) output assigned, then “analog output” will have value 0.

“mode” BACnet object retrieves information about the mode for each sensor type in the zone. Value for mode is a 12-bit number. Bit 11, bit 10, bit 9 and bit 6 are always set to 1. So, this field will have values from 3648 to 4095. If a sensor type has mode set to ‘VOTING’ in Group Configuration of the Zone, then its corresponding bit will be set to 1. And, if the sensor type has mode set to ‘AVERAGE’ then its corresponding bit will be set to 0. E.g. If Zone [1]. mode present value is 4095 then it means that all sensor types in Zone 1 are set to VOTING. Similarly, if Zone [2]. mode present value is 4094 then it indicates that all sensor types in Zone 2 are set to VOTING mode except Type 1 (CO) which is set to AVERAGE mode.

	Type 9 (Bit 8)	Type 8 (Bit 7)	Bit 6	Type 6 (Bit 5)	Type 5 (Bit 4)	Type 4 (Bit 3)	Type 3 (Bit 2)	Type 2 (Bit 1)	Type 1 (Bit 0)
Zone mode	x	x	1	x	x	x	x	x	x

Table 5-5 – Bit Assignment for Zone[N]. mode value

“quorum[X]” is another analog type object for Zone Configuration. If voting mode of operation for a sensor type X (Table 5-1 lists the valid values of type i.e. value of X) is selected, then value of this BACnet object represents quorum value for that sensor type.

Description	BACnet Object Type	BACnet Object Instance
Zone[N] Where N is from 1 to 8	Group [1]	Binary value (N-1) *24
	...	Binary value ...
	Group [9]	Binary value (N-1)*24 + 7
	Horn/Strobe 1	Binary value (N-1)*24 + 8
	Horn/Strobe 2	Binary value (N-1)*24 + 9
	Horn/Strobe 3	Binary value (N-1)*24 + 10
	Horn/Strobe 4	Binary value (N-1)*24 + 11
	Analog output	Analog value 937+(N-1) *14
	Mode	Analog value 937+(N-1) *14+1
	Quorum [1]	Analog value 937+(N-1) *14+2
	...	Analog value ...
	Quorum [12]	Analog value 937+(N-1) *14+13
	Relay 1	Binary value (N-1)*24 + 12
	...	Binary value ...
	Relay 12	Binary value (N-1)*24 + 23

Table 5-6 – BACnet Objects for Zone Configuration

4. Output status and values of DVP-1200 Outputs

When the output (buzzer, Horn/Strobe, Relay) is active the binary output value for corresponding output is set to 1 (active) and when the output is not active then the corresponding output is set to 0 (inactive).

For three analog outputs, the values of corresponding BACnet object represents the current output (in mA) from the analog or 4-20mA output in DVP-1200.

Table 5-7 shows the BACnet objects and corresponding Object Instance for DVP-1200 panel outputs.

Description		BACnet Object Type	BACnet Object Instance
Output Status	Buzzer	Binary output	0
	Horn/Strobe 1	Binary output	1
	Horn/Strobe 2	Binary output	2
	Horn/Strobe 3	Binary output	3
	Horn/Strobe 4	Binary output	4
	Relay 1	Binary output	5
	...	Binary output	...
	Relay 12	Binary output	16
	Analog output 1	Analog output	0
	Analog output 2	Analog output	1
	Analog output 3	Analog output	2

Table 5-7 – BACnet Objects for DVP-1200 Outputs

6 Testing & Maintenance

6.1 Testing

6.1.1 Relay Functionality Test

- Access the Relay Configuration Menu (Refer to Section 4.6.3.1) and select the configuration for relay to be tested.
- Change the “RELAY ON/OFF” to ON and save the configuration. This will activate the corresponding relay and normally open connections will be closed.

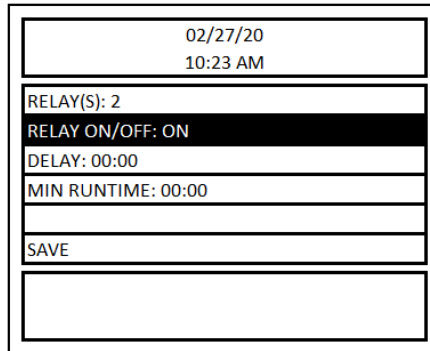

Figure 7-1 –

- Once the test is complete, change the configuration back to desired settings and save it.

6.1.2 Horn and Strobe Functionality Test

- Access the Horn/Strobe Configuration Menu (Refer to Section 4.6.3.3) and select the configuration for Horn/Strobe to be tested.
- Change the “HS ON/OFF” to ON and save the configuration. This will activate the device connected to corresponding Horn/Strobe.

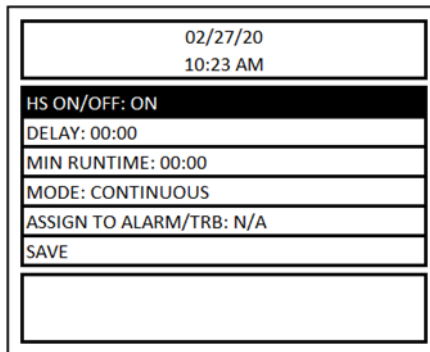

Figure 7-2 –

- Once the test is complete, change the configuration back to desired settings and save it.

6.2 Maintenance

DVP-1200 do not have parts that require regular maintenance.

For fuse replacement, use 5x20 mm slow-blow glass body cartridge fuse with a rating of 1 Amp 250V, e.g. Littelfuse P/N 218001. Be sure to DISCONNECT POWER before removing the safety cover and REPLACE THE SAFETY COVER on F2 before re-applying power to the DVP-1200.

In the event of trouble or any kind of help and support contact Technical Support at +1-844-325-3050

7 Appendix A – Table of Figures

Figure 3-1 – Mounting Holes	8
Figure 3-2 – Typical Layout diagram	9
Table 3-1 – Wire Gauge for run Length	9
Figure 3-3 – DVP-1200 Board Diagram	10
Table 3-2 –	11
Figure 3-4 – System Wiring Diagram	11
Figure 3-5 – MRS-485 Exploded View	12
Figure 3-6 – MRS-485 Wiring Diagram	13
Figure 3-7 –	14
Table 3-3 – Dip Switch Settings.....	15
Figure 3-8 – EOL Jumper Settings	15
Figure 3-9 –	16
Figure 3-10 –	17
Figure 3-11 - EOL Placement.....	19
Figure 3-12 – RR-24 Board Diagram.....	19
Table 3-1 – Baud Rate configuration	20
Table 3-2 – Parity Configuration	20
Table 3-4 –	21
Figure 4-1 –	21
Table 4-1 –	23
Figure 4-2 –	23
Figure 4-3 –	24
Figure 4-4 –	25
Figure 4-5 –	26
Figure 4-6 –	27
Figure 4-7 –	27
Figure 4-8 –	28
Figure 4-9 –	28
Figure 4-10 –	29
Figure 4-12 –	29
Figure 4-13 –	30
Figure 4-14 –	30
Figure 4-15 –	30
Figure 4-16 –	31
Figure 4-17 –	31
Figure 4-18 –	31
Figure 4-19 –	32
Figure 4-20 –	32
Figure 4-21 –	33
Figure 4-22 –	33
Figure 4-23 –	34
Figure 4-24 –	34
Table 4-2 –	35
Figure 4-26 –	36
Figure 4-27 –	36
REV – 1.3.1	[34-8708-4770-7]

Figure 4-28 – 36

Figure 4-29 – 37

Figure 4-30 – 38

Figure 4-31 – 38

Figure 4-32 – 38

Figure 4-33 – 39

Figure 4-34 – 39

Figure 4-35 – 40

Figure 4-36 – 40

Figure 4-37 – 41

Figure 4-38 – 42

Figure 4-39 – 42

Figure 4-41 – 43

Figure 4-42 – 44

Figure 4-43 – 44

Figure 4-44 – 45

Figure 4-45 – 45

Figure 4-46 – 45

Figure 4-47 – 46

Figure 4-48 – 46

Figure 4-49 – 47

Figure 4-50 – 47

Figure 4-51 – 48

Figure 4-52 – 48

Figure 4-53 – 49

Figure 4-54 – 49

Figure 4-55 – 50

Figure 4-56 – 50

Table 4-3 – Event Log Abbreviations 51

Figure 4-57 – Event Log Screen 51

Figure 4-58 – 51

Table 5-1 – Types of Detector 52

Table 5-2 – Engineering Unit 52

Table 5-3 – BACnet Objects for Group Settings of all Zone 54

Table 5-4 – BACnet Object for Detector Reading 54

Table 5-5 – Bit Assignment for Zone[N]. mode value 55

Table 5-6 – BACnet Objects for Zone Configuration 55

Table 5-7 – BACnet Objects for DVP-1200 Outputs 56

Figure 7-1 – 57

Figure 7-2 – 57

8 Appendix C – Replacement Parts

The table below lists replaceable parts for the DVP Control Panels, parts not listed such as the keypad can only be replaced at the factory.

CAUTION: Certification on all DVP Panels is based on testing of the complete assembly. Replacing any part in the DVP Assembly voids the certification and user must remove the ETL label applied on the panel.

Product Model	Replacement Part	Part Number
DVP-120 All Models	DVP-120 Replacement Power Supply Assembly	70-2900-0017-0
DVP-120 All Models	DVP-120 Replacement Buzzer	70-2900-0017-1
DVP-120 All Models	DVP-120 Replacement Lock/Keys	70-2900-0017-6
DVP-120	DVP-120 Replacement Board	70-2900-0017-2
DVP-120M	DVP-120M Replacement Board	70-2900-0017-5
DVP-120B	DVP-120B Replacement Board	70-2900-0017-3
DVP-120C	DVP-120C Replacement Board	70-2900-0017-4
DVP-1200	DVP-1200 Replacement Board	70-2900-0017-7

9 Appendix D – Setup Record

Record network parameters and keep in a safe place to assist with installation and future troubleshooting will be simplified.

Date of Install: _____

Serial Number: _____

Location of Install: _____

Installed by: _____

Detectors / Sensors

Under Detector type record gas type (e.g. CM-6, TX-6-ND, OX-12)

Note that CX-6 uses two addresses, one for each gas type.

Modbus Address	Detector Type	Location	Modbus Address	Detector Type	Location	Modbus Address	Detector Type	Location
1			34			67		
2			35			68		
3			36			69		
4			37			70		
5			38			71		
6			39			72		
7			40			73		
8			41			74		
9			42			75		
10			43			76		
11			44			77		
12			45			78		
13			46			79		
14			47			80		
15			48			81		
16			49			82		
17			50			83		
18			51			84		
19			52			85		
20			53			86		
21			54			87		
22			55			88		
23			56			89		
24			57			90		
25			58			91		
26			59			92		
27			60			93		
28			61			94		
29			62			95		
30			63			96		
31			64			97		
32			65			98		
33			66			99		

Modbus Address	Detector Type	Location	Modbus Address	Detector Type	Location	Modbus Address	Detector Type	Location
100			134			168		
101			135			169		
102			136			170		
103			137			171		
104			138			172		
105			139			173		
106			140			174		
107			141			175		
108			142			176		
109			143			177		
110			144			178		
111			145			179		
112			146			180		
113			147			181		
114			148			182		
115			149			183		
116			150			184		
117			151			185		
118			152			186		
119			153			187		
120			154			188		
121			155			189		
122			156			190		
123			157			191		
124			158			192		
125			159					
126			160					
127			161					
128			162					
129			163					
130			164					
131			165					
132			166					
133			167					

Relays and outputs

Relay connection	Connected device	Zone Configured	Delay	Runtime
Relay 1				
Relay 2				
Relay 3				
Relay 4				
Relay 5				
Relay 6				

Relay 7				
Relay 8				
Remote – Relay 9				
Remote – Relay 10				
Remote – Relay 11				
Remote – Relay 12				
Horn/Strobe 1				
Horn/Strobe 2				
Horn/Strobe 3				
Horn/Strobe 4				
4-20mA output 1				
4-20mA output 2				
4-20mA output 3				

Notes:

10 Macurco Gas Detection Product limited warranty

Macurco warrants the DVP-1200 control ventilation panel will be free from defective materials and workmanship for a period of two (2) years from the date of manufacture (indicated on inside cover of the DVP-1200), provided it is maintained and used in accordance with Macurco instructions and/or recommendations. If any component becomes defective during the warranty period, it will be replaced or repaired free of charge, if the unit is returned in accordance with the instructions below. This warranty does not apply to units that have been altered or had repair attempted, or that have been subjected to abuse, accidental or otherwise. The above warranty is in lieu of all other express warranties, obligations, or liabilities. THE IMPLIED WARRANTIES OF MERCHANTABILITY AND FITNESS FOR PARTICULAR PURPOSE ARE LIMITED TO A PERIOD OF TWO (2) YEARS FROM THE PURCHASE DATE. Macurco shall not be liable for any incidental or consequential damages for breach of this or any other warranty, express or implied, arising out of or related to the use of said gas detector. The manufacturer or its agent's liability shall be limited to replacement or repair as set forth above. Buyer's sole and exclusive remedies are the return of the goods and repayment of the price, or repair and replacement of non-conforming goods or parts.

*Modbus is a trademark or registered trademark of Schneider Automation Inc.

*BACnet is a registered trademark of ASHRAE.

Macurco Gas Detection

3601 N. St. Paul Avenue
Sioux Falls, SD 57104

Technical Support Contact Information

Phone: 1-844-325-3050

Fax: 1-605-951-9616

Email: support@macurco.com

Website: www.macurco.com/support/

General Contact Information

Phone : 1-877-367-7891

Fax : 1-605-951-9616

Email: info@macurco.com

Website: www.macurco.com

REV – 1.3.1

Issue Date: 09-29-2020

Document No: 34-8708-4770-7

© Aerionics 2020. All rights reserved.

Macurco is a trademark of Aerionics, Inc.

