

Ammonia-specific Electrochemical Gas Sensor/Transmitter

Manning EC-F9-NH₃ Instruction and Installation Manual

04/13

Certified for electrical shock and electrical fire hazard only.
La certification couvre uniquement les risques de chocs électriques et d'incendies d'origine électrique.

Release F

Honeywell Confidential and Proprietary

This work contains valuable, confidential, and proprietary information. Disclosure, use or reproduction outside of Honeywell Inc. is prohibited except as authorized in writing. This unpublished work is protected by the laws of the United States and other countries.

Notices and Trademarks

Copyright 2013 by Honeywell International Inc.

Release F April 2013

While this information is presented in good faith and believed to be accurate, Honeywell disclaims the implied warranties of merchantability and fitness for a particular purpose and makes no express warranties except as may be stated in its written agreement with and for its customers.

In no event is Honeywell liable to anyone for any indirect, special, or consequential damages. The information and specifications in this document are subject to change without notice.

Manning is a registered trademark of Honeywell International Inc.

Other brand or product names are trademarks of their respective owners.

Honeywell Analytics
23500 W. 105th St. MD 400
Olathe, KS 66061

847 955 8200
800 538 0363

detectgas@honeywell.com
www.honeywell.com

About This Document

World Wide Web

The following Honeywell web sites may be of interest to Industry Solution customers.

| Honeywell Organization | WWW Address (URL) |
|------------------------|--|
| Corporate | www.honeywell.com |
| Honeywell Analytics | www.honeywellanalytics.com |
| Manning Gas Detection | www.manningsystems.com |

Telephone

Contact us by telephone at the numbers listed below.





| Organization | | Phone Number |
|------------------------|--|------------------|
| United States / Canada | Honeywell Analytics Inc. Lincolnshire, IL | 1-800-538-0363 |
| Service | | 1-800-321-6320 |
| Asia Pacific | Honeywell Asia Pacific Inc. Hong Kong | (852) 23 31 9133 |
| Europe | Honeywell PACE Brussels, Belgium | {32-2} 728-2711 |
| Latin America | Honeywell International Inc. Lincolnshire, IL | 1-847-955-8200 |

Sales Information

Contact us at detectgas@honeywell.com

Symbol Definitions

The following table lists those symbols used in this document to denote certain conditions.

| Symbol | Definition |
|---|--|
|  | ATTENTION: Identifies information that requires special consideration. |
|  | TIP: Identifies advise or hints for the user, often in terms of performing a task. |
|  | REFERENCE-EXTERNAL: Identifies an additional source of information outside of this bookset. |
|  | REFERENCE-INTERNAL: Identifies an additional source of information within this bookset. |
| CAUTION | indicates a situation which, if not avoided, may result in equipment or work (data) on the system being damaged or lost, or may result in the inability to properly operate the process. |
|  | CAUTION: Indicates a potentially hazardous situation which, if not avoided, may result in minor or moderate injury. It may also be used to alert against unsafe practices. CAUTION symbol on the equipment refers the user to the product manual for additional information. The symbol appears next to required information in the manual. |

Contents

Serial number:

| Section | Title | Page |
|---------|--|------|
| 1 | System Description | 6 |
| | Specifications | 6 |
| 2 | Installation | 7 |
| | A Locating the Manning EC-F9-NH ₃ Sensor | 7 |
| | B Wiring | 9 |
| 3 | Operation | 11 |
| | A Start-up Procedures | 11 |
| | B Pushbutton Operation and LED Indicators | 11 |
| | LED Blink Sequence | 11 |
| | LED Sequence Indicator and Operation Summary | 13 |
| | SensorCheck™ | 14 |
| | 4/20 mA Loop Check | 14 |
| | Simple Zero Test | 15 |
| | Span Calibration Mode | 15 |
| | Modbus Address Change | 17 |
| | C Troubleshooting | 18 |
| | D Maintenance | 19 |
| | EC Cell Replacement Procedure | 19 |
| | E Replacement Parts | 19 |
| 4 | Limited Warranty | 20 |

Introduction

This manual has been prepared to help in the use and installation of the Manning EC-F9-NH₃ (Electrochemical-Ammonia) Sensor. This manual will convey the operating principles of the sensor, ensure proper installation, and demonstrate start-up and routine maintenance procedures for the sensor.



ATTENTION: This manual must be carefully followed by all individuals who have or will have the responsibility for using or servicing the sensor. Warranties made by Honeywell Analytics with respect

to this equipment will be voided if the equipment is not used and serviced in accordance with the instructions in this manual. If in doubt about a procedure, please contact Honeywell Analytics before proceeding.

1 System Description

The Manning EC-F9-NH₃ Sensor is a three-wire, 4/20 mA sensor, with optional RS-485 Modbus RTU communication, designed for low-level ammonia detection available in ranges of 0–100 ppm, 0–250 ppm, 0–500 ppm, and 0–1,000 ppm.

The unit exhibits excellent accuracy and precision, with negligible response to common interference gases and dramatic changes in relative humidity. Reliable trip levels as low as 25 ppm can be expected with the 0–100 ppm sensor. The unit exhibits extremely high reliability with no moving parts.

Monitoring equipment must be configured to indicate a fault if the signal is less than 1.5 mA. All signals over 20 mA must be considered a high gas concentration.

Specifications

Method: Electrochemical (diffusion)

Ranges: 0–100 ppm (standard)

0–250 ppm

0–500 ppm

0–1,000 ppm (requires High-Range cell)

Output: Isolated 4/20 mA, 700 ohms max at 24 VDC. Signal output reduces to 0.5 mA to indicate a fault condition.

RS-485 Protocol: MODBUS RTU

Accuracy: ± 5% generally, but limited by available calibration gas accuracy

Repeatability: ± 2% full scale

Response Time: T₅₀ = 10 seconds,
T₁₀₀ = 1 second for concentrations >1% NH₃

Sensor Viability Test: An internal microprocessor determines the sensor's electrical viability every 24 hours (SensorCheck™). Should the electrical viability test fail, a 0.5 mA signal will indicate a fault.

A red LED on the circuit board will indicate if a sensor is degraded electrically, dried up or disconnected.

4/20 mA Loop Viability Test: Internal monitoring of 4/20 mA output impedance

Operating Humidity: 5–100% RH (condensing). ATMOS equipped® enviro-adaptive technology option required for condensing conditions or refrigerated areas, and all outdoor applications.

Operating Temperatures: –50° F to +120° F. ATMOS equipped® enviro-adaptive technology option required for refrigerated areas or outdoors.

Sensor Pressure Limits: 0–10 PSIG

Power Source: 24 VDC (recommended), 0.5 amp max. 14–26 VDC acceptable. **NOTE:** If sensor is ATMOS equipped®, contact Honeywell Analytics if supply voltage is less than 16 VDC.

Cable Recommendations:

4/20 output: #18/3 shielded cable (Belden #8770 or equal), cable runs <1,500 feet.

Modbus RTU (RS-485): For communication cable, use 24 AWG twisted pair, shielded (Belden #9841 or equal), cable runs up to 2,000 feet. For power cable, use 14 AWG (Belden #5100UE or equal), cable runs up to 1,000 feet, for each power supply. Larger power cable and/or additional power supplies may be required for longer cable runs and/or increased number of sensors. Due to variables such as sensor current draw, line loss, and cable size, contact Honeywell Analytics for help with power requirements.

Gas Sampling: Diffusion method is standard.

Enclosure: NEMA 1, gasketed, #16-gauge steel (standard). Stainless steel or explosion-proof designs, including modified enclosures for low temperatures, ventilation ducts, etc., are available (contact Honeywell Analytics).



NOTE: The standard EC is for use in non-classified areas only.

Weight: 3 lbs.

Dimensions: 6" high x 4" wide x 3.5" deep

2 Installation

A Locating the Manning EC-F9-NH₃ Sensor

Because each sensor is a point measurement, **it is very important that the sensor be located properly.**



One of the most important considerations when installing EC sensors is that they must be easily accessible for calibration and maintenance. As a general rule, locate sensors no closer than one foot from the ceiling.

If the primary application is **personal protection** (representative concentration reading that an employee would be exposed to), mount the sensor at a height in the breathing zone of the employees. It would typically be about five feet off the ground, which also allows easy access.

If the primary application is the fastest possible leak detection, mount the sensor near the potential leak sources. In the case of ammonia, this is usually near the ceiling as ammonia vapor is lighter than air. In certain refrigeration applications, ammonia vapors from an NH₃ leak will remain at a low elevation. In these cases, leak detection will take longer if the sensor is mounted at high elevation and the indicated concentration will not be representative of personnel exposure. Higher mounting locations can also complicate access to the sensor for required calibration and maintenance. For more information on sensor mounting locations for different leak scenarios, please contact Honeywell Analytics.

No matter where the sensor is mounted, it must be easily accessible.

CAUTION General Mounting Considerations:

- Must be easily accessible for calibration and maintenance.
- Mount the sensor close to the potential leak source.
- If personnel protection is the primary application, mount in the “breathing zone”.
- Protect sensor from water, excessive humidity, and wash-down.
- Take air movement and ventilation patterns into account.

- If mounting sensor outdoors, consider prevailing wind direction and proximity to the most likely source of leaks. Protect the sensor from sun and rain as much as possible.
- Never mount the sensor in CA (controlled atmosphere) rooms because normal atmospheric level of oxygen is required for operation.
- For highly critical locations, more than one sensor should be installed in each room.
- To prevent electrical interference, keep sensor and wire runs away from mercury vapor lights, variable speed drives, and radio repeaters.
- Protect sensor from physical damage (fork lifts, etc.).
- Do not mount the sensor over a door in a refrigerated area.

Figure 1. Mounting Dimensions

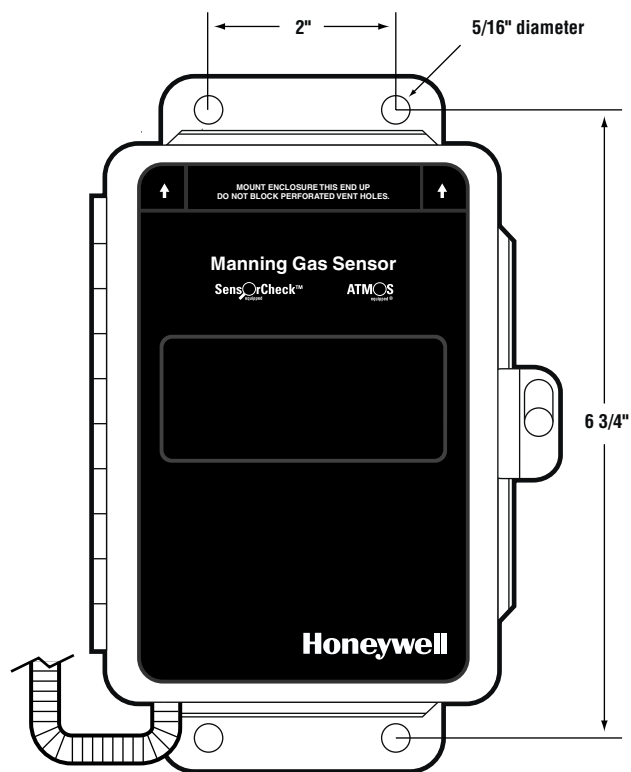

2 Installation continued

CAUTION

- Sensor **must** be mounted vertically.
- **Never** mount flat on a ceiling.
- Enter enclosure **only** through existing hole in bottom.
- **Always** make a drip loop in the conduit (see Figure 1).

Blast Freezers: Never mount sensor above the coil. The ideal location, when possible, is below the bottom of the coil. Try to put in return air and protect the unit from being damaged by product loading and unloading. Keep it away from warm, moist air during defrost. Usually four or five feet off the ground is the best location.

Penthouses:

Multi-Coil (defrost one coil at a time): In this case the best location is usually in the center of the penthouse four or five feet above the grate.

Single Coil (or when all coils defrost at the same time): In this case high moisture conditions can occur and the sensor should be mounted one foot above the grate.

Engine Rooms: The Manning EC sensor should be mounted in a cool part of the room, if possible. Keep the sensor away from hot air exhausting from electric motors or other machinery. Usually the best location is four or five feet above the floor in a location where the room exhaust fan will move air across the sensor from the potential leak source.

Ceiling-Hung Evaporators: When mounting Manning EC sensors near evaporators, mount the sensor no higher than two feet below the top of the evaporator coil. **DO NOT** mount in high air flow (1,200 feet/ minute maximum). **NEVER** mount the sensor on evaporators as vibration can damage the sensor.

Other Locations: When mounting Manning EC sensors in locations such as roof top air units, ductwork, attic spaces, makeup air intakes, etc., contact Honeywell Analytics for application assistance and recommendations.

2 Installation continued

B Wiring

Figure 2 presents 4/20 mA output wiring information for the Manning EC-F9-NH₃ sensor. Figure 3 presents RS-485 communication wiring information for the Manning EC-F9-NH₃ sensor.

Electrical wiring must comply with all applicable codes. Plant equipment that may be involved and operating conditions should be discussed with local operating personnel to determine if any special needs should be taken into account.

Almost all start-up problems are due to improper wiring or monitor configuration. Please follow these guidelines carefully.

CAUTION Do not pull sensor wiring with AC power cables. This will cause electrical interference. Be sure there are no breaks or splices in sensor wiring runs. If cable runs cannot be made without a splice, all connections must be soldered. Soldering should be done using a rosin flux to tie the connecting ends of sensor wires to ensure a positive and long-lasting contact.

Ground the shield at the main control panel. Connect the shield wire in the sensor terminal block labeled *SHLD*. Tape all exposed shield wire at the sensor to insulate it from the enclosure.

All penetrations into a refrigerated room should be sealed to prevent condensate from forming in the conduit and dripping into the sensor enclosure.

Make drip loops for cables going into sensor housings. When heated enclosures are used, follow the special mounting instructions on the enclosure (...*This End Up*).



Mount sensor enclosures through the flange holes as shown in Figure 1, and *always mount vertically*.

4/20 mA output: Always use three conductor, insulated, stranded, shielded copper cable. Use only three conductor cable, not two cables of two conductor wire.

RS-485 output: Always use two conductor twisted pair, insulated, stranded, shielded copper cable for the communication cable. Use two conductor, insulated, stranded cable for sensor power.

With RS-485, the communication cabling of the network is “daisy chained”, with multiple devices (sensors, relay modules, etc.) communicating along the same pair of wires. If used with the Manning AirAlert™96d controller, up to 32 devices can be wired in series per channel (up to three channels). Refer to



the controller manual for specific wiring details.

CAUTION When many sensors are connected to one set of power cables, total current draw may exceed cable recommendations and/or cause considerable line-loss. Contact Honeywell Analytics for recommendations on power cable sizing and additional power supplies.

Figure 2. 4/20 mA Output Wiring Diagram

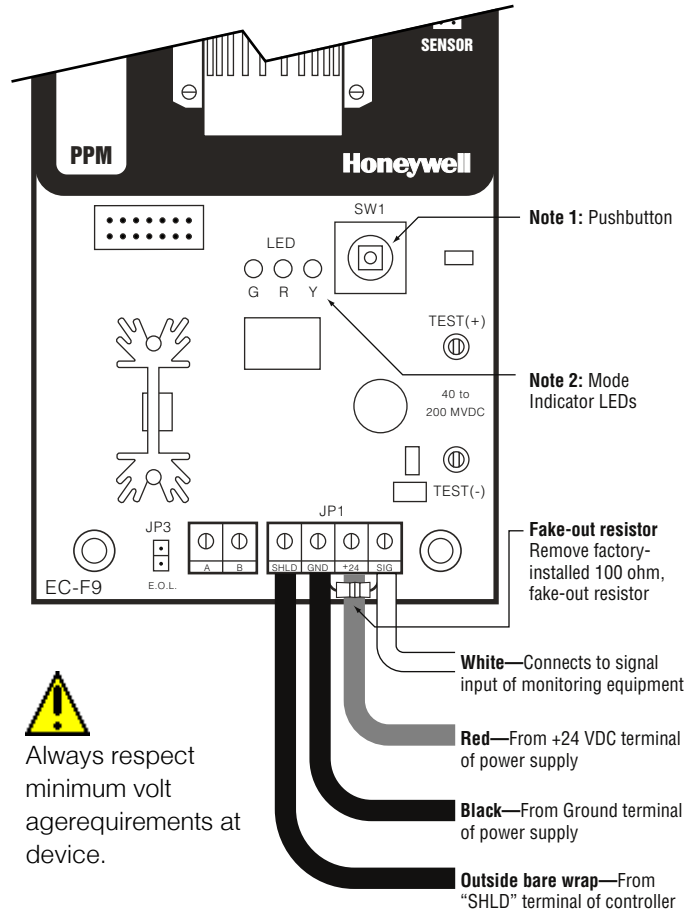

2 Installation continued

Electrical Power: 24 VDC regulated, 30 mA. With an ATMOS equipped® enclosure the current draw is 400 mA max.



Respect minimum voltage requirements.

Outputs:



ATTENTION: The Manning EC-F9 sensor is shipped with a 100 ohm, 1/4 watt resistor in the green, four position terminal block, across the Signal and Ground terminals (see Figure 3). This resistor is needed to “fake out” the 4/20 mA loop if using the Modbus RTU output. Only remove this resistor if using the 4/20 mA output.

4/20 mA: Circuit board mounted sensor provides a linear 4/20 mA output. Monitoring equipment may have a maximum input impedance of 700 ohms.

RS-485: MODBUS RTU communication protocol.

Cable Recommendation:

4/20 mA output: Use #18/3 shielded cable (Belden #8770 or equivalent). Length of cable to sensor should be no greater than 1,500 feet. Use only the existing punched holes for connections to the sensor.

RS-485: For communication cable, use 24 AWG twisted pair, shielded (Belden #9841 or equal), cable runs up to 2,000 feet. Avoid “T-taps” if possible. Do not exceed 65 feet per T-tap. Do not exceed 130 feet total of all T-taps (per channel). For power cable, use 14 AWG (Belden #5100UE or equal), cable runs up to 1,000 feet, for each power supply. Larger power cable and/or additional power supplies may be required for longer cable runs and/or increased number of sensors. Due to variables such as sensor current draw, line loss, and cable size, contact Honeywell Analytics for help with power cable requirements.

CAUTION Follow cable recommendations.

Monitoring: The Manning EC-F9-NH₃ Ammonia Sensor may be monitored by the Manning GM-10, GM-4, GM-1, GM-JR, AirAlert™96d, or other appropriately configured system. For 4/20 output, monitoring equipment must be configured to indicate a fault if the signal is below 1.5 mA. All signals over 20 mA must be considered a high gas concentration, *not* a fault condition.



NOTE for PLC applications: The signal output load can range from 0 to 700 ohms, where the maximum load resistor at a 24 VDC supply is 700 ohms and the maximum load resistor at a 10 VDC supply is 267 ohms. Any load outside these values will indicate a fast flash on the red LED while in operation or this test mode during normal operation. The error LED will blink fast at any time if the signal output cannot source the necessary current.

Figure 3. RS-485 Communication and Power Wiring Diagram

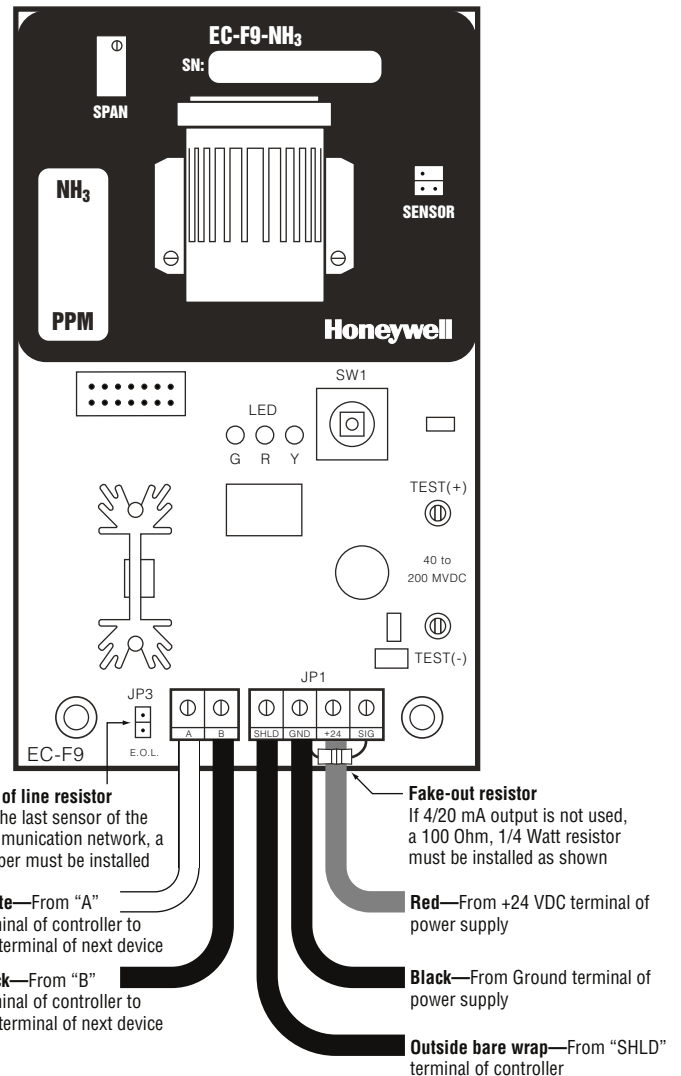

3 Operation

A Start-Up Procedures

Before applying power, make a final check of all wiring for continuity, shorts, grounds, etc. It is usually best to disconnect external alarms and other equipment from the sensor until the initial start-up procedures are completed. SensorCheck™ is initiated each time the unit is powered up.

After power-up, allow 24 hours for the system to stabilize before testing the sensors. Because sensors are normally located at a distance from the main unit, the test time required and accuracy of the response checks will be improved if two people perform the start-up procedures and use radio contact.

Simple Start-Up Test:

- One person exposes each sensor to a small amount of the gas that is being monitored.
- The second person stays at the control unit to determine that each sensor, when exposed to the gas fumes, is connected to the proper input and responds, causing appropriate alarm functions.

B Pushbutton Operation and LED Indicators

The Manning EC-F9-NH₃ has an internal pushbutton that is utilized for navigation of test functions and operating modes (see Figure 5, Note 5). It also has a group of LEDs (green, red, yellow – see Figure 3) that blink in specific sequences to indicate sensor operation modes. A summary of sensor operation modes and corresponding LED blink sequences is shown in Figure 6. The pushbutton must be pressed the correct number of times and at the correct rate.







- When a multi-press sequence must be performed, the button must be pressed rapidly and evenly, lifting one's finger completely from the actuator for each consecutive press.

- For press and hold activations, one's finger must always be applying a down pressure without disruption for the specified time in order to activate the desired mode.
- See complete details of each operation in other parts of the manual. 

The Manning EC-F9-NH₃ has been designed with three distinct test mode procedures that are triggered by the appropriate push button action. These test modes include Manual SensorCheck™, Simple Zero Test, and 4/20 mA Loop Check.

The fourth operation puts the unit into Calibration Mode to allow for testing with a certified calibration gas standard and to provide information for appropriate span adjustments, if required.

Figure 4. LED Blink Sequence

| | |
|---------------|---|
| SLOW BLINK |  |
| MEDIUM BLINK |  |
| FAST BLINK |  |
| CONTINUOUS ON |  |

3 Operation continued

Green LED

- Solid ON – all modes except Cal. and 4/20 mA calibration.
- Slow Blink – Calibration mode.

Red LED

- Solid ON – Possible catastrophic failure on the circuit board. The 4/20 mA signal will vary depending on the exact failure. In the event of corrupted data, calibration values and Modbus ID may be lost but the gas sensor and 4/20 mA output circuit would still be operational. In the event of a CPU failure, a 0.5 mA fault signal is output from the sensor. All other functions and devices would be inoperable (optional LCD, network, pushbuttons, etc.). Contact Honeywell Analytics for technical support.
- Slow Blink – Near death, possible dried up or disconnected Cell. A 0.5 mA fault signal is output from the sensor during this error event. A replacement cell should be ordered at this time.
- Medium Double Blink – Possible weak cell. Cell is nearing the end of its useful life. Although the sensor may pass the span calibration or detect the presence of ammonia, frequent attention and increased calibration checks are strongly recommended until the cell is replaced.
- Fast Blink – Possible 4/20 mA loop failure or load resistance too high. Check output impedance and ensure it is between 10Ω and 700Ω referenced to ground. In addition, ensure power supply voltage is within specified operating range.

Yellow LED

- Solid ON – During Sensor Check™.
- Medium Double Blink – During 4/20 mA (0.5 mA low) test.
- Fast Blink – During 4/20 mA (22 mA high) test and during failed (22 mA high) test.

Green – ON, Red – Fast Blink, Yellow – Fast Blink

- 4/20 mA loop test failed the 22 mA high extremity. Check output impedance and ensure it is between 10Ω and 700Ω referenced to ground. In addition, ensure power supply voltage is within specified operating range.

Figure 5. Manning EC-F9-NH₃ Sensor Components

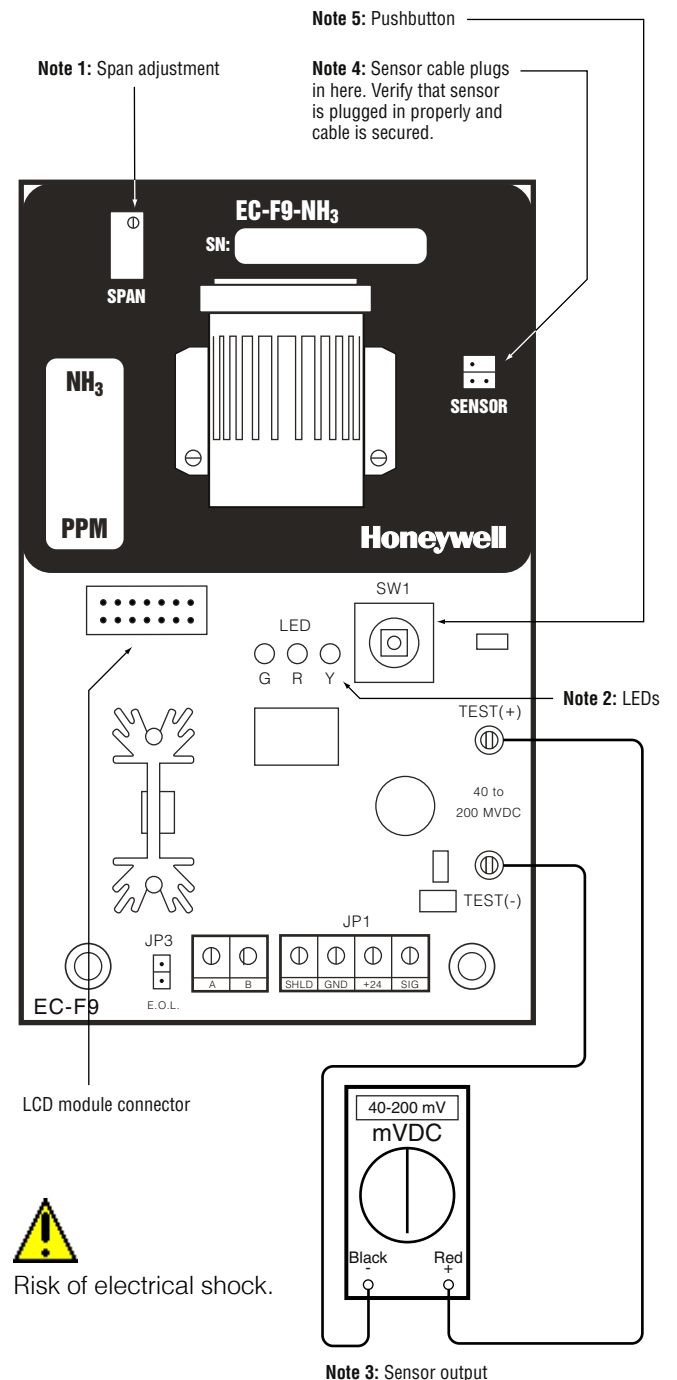

3 Operation continued

Figure 6. LED Sequence Indicator and Operation Summary

| MODE | Ⓜ GREEN LED (left) | Ⓜ RED LED (center) | Ⓜ YELLOW LED (right) | NOTE |
|---|--------------------|--------------------|----------------------|------|
| Normal Run Mode | ————— | | | |
| ↓ During Span Calibration Mode | — — — | | | 3 |
| During Simple Zero Test | — — — | | | |
| ↓ Manual SensorCheck™ | ————— | | ————— | 1 |
| Weak Cell | ————— | · · · · · | | |
| Failed or Disconnected Cell | ————— | — — — | | 2 |
| Hardware failure | | ————— | | 2 |
| ↓ During 4/20 mA Loop Test (22 mA high) | ————— | | ····· | |
| Failed Loop Test (22 mA high) | ————— | ····· | ····· | |
| ↓ During 4/20 mA Loop Test (.5 mA low) | ————— | | · · · · · | |
| Failed Signal Output | ————— | ····· | | 4 |

NOTE 1: SensorCheck™ automatically every 24 hours. Manual test can be initiated.

NOTE 2: Unit will output 0.5 mA.

NOTE 3: Exits mode after 10 minutes or if pushbutton is pressed for one second.

NOTE 4: Occurs due to wiring problem or incorrect load value.

 = Initiated by button press

3 Operation continued

SensorCheck™

SensorCheck™ is a microprocessor-based technology that monitors and predicts the electrical viability of its electrochemical and infrared ammonia sensors by testing every 24 hours. If the sensor dries up or is disconnected, SensorCheck™ sends an indication that can be detected by a Manning Gas Monitor or PLC.

The red LED will indicate if a sensor starts to degrade electrically causing marginal operation requiring frequent attention and increased calibration checks. Should the electrical viability test fail, the unit outputs a 0.5 mA signal to indicate this fault condition.



The SensorCheck™ electrical viability test is not, however, meant to replace adherence to the factory-recommended calibration schedule. SensorCheck™ is an internal electrical test that is not capable of verifying physical aspects such as blockage of the sensor membrane by dirt, flour, grease, water, paint, etc.

Physical blockage is rare, but does occasionally happen, especially in many harsh processing environments.

NOTE: SensorCheck™ is not intended to measure or indicate the chemical viability of a sensor operating in high or continuous concentration of NH₃.

Although SensorCheck™ is performed automatically every 24 hours, at any time a manual sensor check can be performed.

To perform a manual SensorCheck™, follow the procedure below:

Start: Press button (see Figure 4, Note 5) three times within two second time limit (test takes about 15 seconds). During test, green and yellow LED's are both continuous ON.

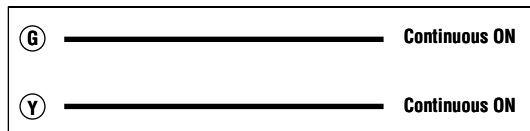

Exit: Unit resumes normal mode automatically after about 20 seconds. Green LED remains continuous ON and yellow LED is unlit.

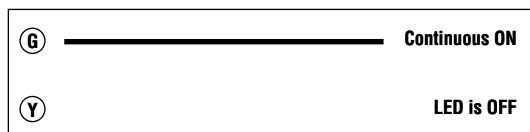

4/20 mA Loop Test

NOTE: This test is recommended especially for PLC operations (non-Manning readout/alarm unit).

NOTE: This test will *not* automatically time out. You must force the unit into normal operation.

Full Scale Test: This test will verify that the full-scale output of the sensor is also achieved at the PLC.

Start: Place meter leads on Test (+) and Test (-). Press button five times within a two- or three-second period of time. The voltmeter should read approximately 220 mV (equal to 22.0 mA output). Verify full-scale signal at PLC. **NOTE:** some PLCs limit input to 20 mA. Blink sequence will be:

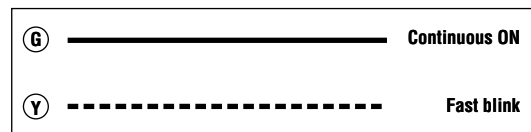

Signal Fault Test: This test will simulate one of many sensor fault conditions in which the transmitter will send 0.5 mA to the control panel. To check for downscale fault verification, press button for one second (voltmeter should read approximately 5 mV (equal to 0.5 mA output). Verify downscale fault indication at PLC. Blink sequence will be:



PLC and monitoring equipment should indicate Fault at this extremely low signal output, (i.e., Honeywell Analytics recommends fault indication on any signal below 1.5 mA.)

Exit: Press and hold button for one second. Sensor will exit test and return to normal operation.

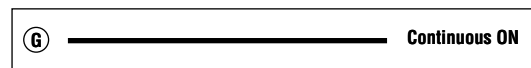

NOTE: This test will *not* automatically time out. You must force the unit into normal operation.

3 Operation continued

Simple Zero Test

Start: With meter set to mVDC, place leads on Test (+) and Test (-) (see Figure 4, Note 3). Press and hold button for one second to enter the Calibration Mode.



- Unplug the cell from the pre-amp.
- Observe the 4/20 mA signal which should be approximately 4.0 mA (40 mV on meter). Range should be 39.4 to 40.6 mV. If sensor output is not in this range, contact Honeywell Analytics.
- Plug cell back into pre-amp. Wait for cell to stabilize at approximately 4.0 mA.

Exit: Press and hold button for one second (places unit in Normal Operation Mode).

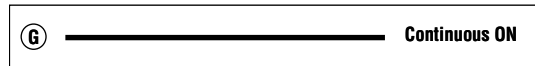

PLC and monitoring equipment should indicate Fault at this extremely low signal output, (i.e., Honeywell Analytics recommends fault indication on any signal below 1.5 mA.)

Exit: Press and hold button for one second. Sensor will exit test and return to normal operation. Blink sequence will be:

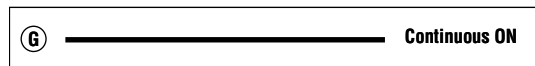

Span Calibration Mode



NOTE: If using the Modbus RTU output with the Manning AirAlert™96d controller, while in calibration mode, alarms A, B, and C will not be activated during calibration of the sensor.



NOTE: When replacing an aged or non-responsive cell, the new cell may cause an erratic or jumpy signal, sometimes causing false alarms. This is usually caused by excessive gain leftover from adjusting the span pot (increasing the sensitivity) for the old cell. Once the span calibration is performed on the new cell, the gain will be decreased to match the sensitivity of the new cell, reducing the jumpiness of the new cell.



NOTE: It is not recommended that any span gas with a concentration lower than 1/2 of the full-scale range is used for span calibration. For example, for a 0/500 ppm ranged sensor, do not use span gas lower than 250 ppm.

The Manning EC-F9-NH₃ comes factory calibrated and should require minimal adjustments after installation. There is one pot on the preamp that is



used for Span calibration (see Figure 4, Note 1). There is no zero pot as the pre-amp is factory zeroed and should not require any further adjustment.

Calibration Kits are available from Honeywell Analytics. Each calibration kit contains certified calibration gas and complete detailed instructions for calibration of all Manning sensors.

3 Operation continued

Span Calibration

The unit is factory calibrated and normally does not need to be spanned upon initial installation. Do not adjust the span pot without certified calibration gas!

If span calibration is required, follow the procedure below:

Start:

- With meter set to mVDC, place leads on Test (+) and Test (-).
- Make sure signal is resting at 4.0 mA. If sensor is not outputting 4.0 mA, see *Troubleshooting* on Page 18.
- Press and hold button for 1–2 seconds. Green LED shows slow blink during test procedure.

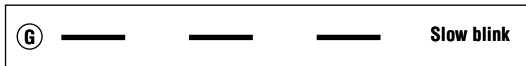

- Apply span gas at 0.8 L/min (span gas must be in air, not nitrogen or other carrier).
- After span gas has been on sensor for a maximum of two minutes or achieving peak level, adjust the span pot until the correct output is achieved (see Figure 4, Note 1).
- If full scale calibration gas is used, output should be 200 mV. If required, use “Span” potentiometer to adjust output to 200 mV (20 mA). If “mid-range” cal gas is being used, refer to the formula in the following section.

Exit: Press and hold button for one or two seconds. Green LED (left) on continuous (normal operation).

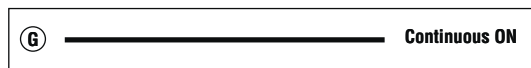

NOTE: The Span Calibration Mode will automatically time out after 10 minutes.

Span Signal Formula

Normal span gas is full scale. In case it is not full scale, use the following formula:

$$\text{Signal (mA)} = \left[\frac{\text{ASGC}}{\text{SFSV}} \right] \times 16 + 4$$

Where:

ASGC = Available Span Gas Concentration

SFSV = Sensor Full Scale Concentration Value

Example: If 100 ppm ASGC gas is used to calibrate a 250 ppm SFSV sensor, the signal would be as follows:

$$\text{Signal} = \left[\frac{100 \text{ ppm}}{250 \text{ ppm}} \right] \times 16 + 4 = 10.4 \text{ mA}$$

10.4 mA = 104 mV from TEST (-) to TEST (+)

If the correct output cannot be achieved, a replacement cell is required.

3 Operation continued

MODBUS Address Change



NOTE: To view or change the Modbus address, the Manning CalPro™ LCD Module is required. Contact Honeywell Analytics to obtain the module.



NOTE: No two devices on the network can have the same address. Each device needs to have a unique address.

Each device requires an address to communicate with the controller on the network. The Modbus address normally comes factory programmed and does not require to be programmed at startup. If it is determined that the Modbus address needs to be

Using the LCD module to view or change the Modbus address: The LCD module has two push-buttons; *Accept* and *Scroll*, which will be utilized for this procedure (see Figure 7).

NOTE: To display the Modbus address, press the *Scroll* button anytime during normal operating mode.

- 1 Plug in the LCD module to the LCD port on the PCB (see Figure 7).
- 2 This module will power-up immediately and will display the normal (idle) operating display.
- 3 Press the *Accept* button.
- 4 You will then be prompted for a password. The password is *MA*.
- 5 Use the *Scroll* button to change the first letter to *M*. Then press the *Accept* button.
- 6 You will then be prompted to change the second letter. If it is already set to *A*, press the *Accept* button.
- 7 If the correct password is entered, you will be sent to the MAIN MENU.
- 8 In the MAIN MENU, scroll until the *ModbusID?* screen is displayed.
- 9 Press *Accept* to enter *Modbus Address Change* menu. The current programmed Modbus address will be displayed (if not programmed at the factory, the default address is 001).
- 10 If the Modbus address is correct, keep pressing the *Accept* button until you are prompted to accept the current Modbus address. You will then be returned to the MAIN MENU.

- 11 If the Modbus address is not correct, using the *Accept* and *Scroll* buttons, change the Modbus address the correct value.
- 12 You will then be prompted to save the changes. Press *Accept* to save, and *Scroll* to abort. You will then be returned to the MAIN MENU.
- 13 Use scroll button to navigate through the main menu. To exit the menu, scroll until the LCD displays *Quit?* and press the *Accept* button. This will return you to normal operating mode. The LCD module can be unplugged at this time.

NOTE: After 5 minutes of inactivity, the LCD returns to normal (idle) operating display.

Figure 7. CalPro™ LCD Module

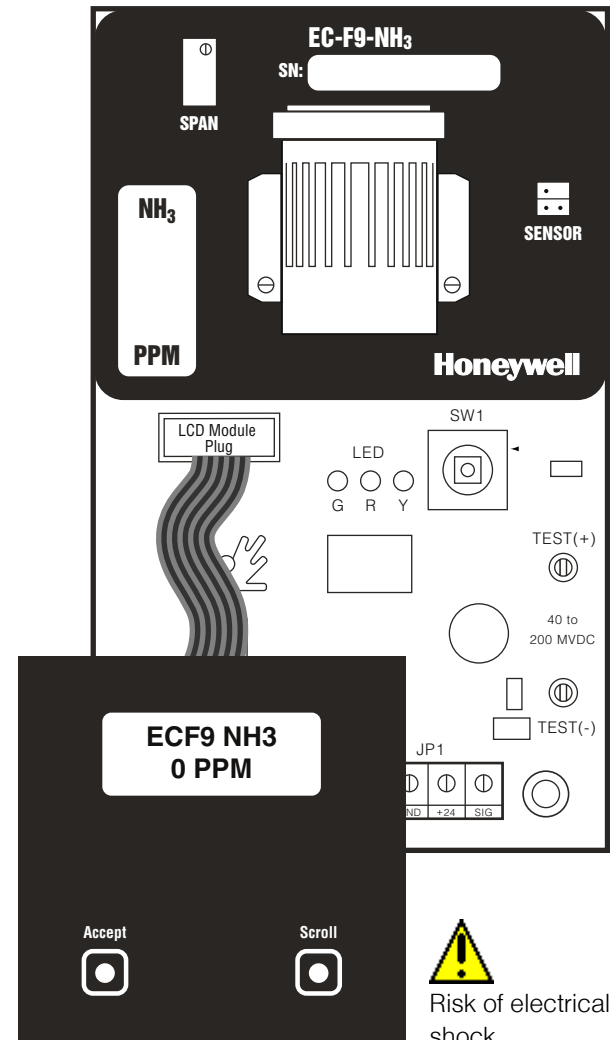

3 Operation continued

c Troubleshooting



Risk of electrical shock.

The LEDs will give visual indication of several sensor and transmitter conditions.

If the sensor output is 0 mA: First, verify +24 VDC at the sensor terminal block (see Figure 8, Note 2).

Second, check voltage between Test (-) and Test (+) (see Figure 8, Note 3). Voltage should be in the range of 40 mV to 200 mV corresponding to an actual current flow of 4 mA to 20 mA. If this voltage is 0 mV, the signal has no path to ground. Check monitoring equipment connections and configuration.

If the sensor output is 0.5 mA: Indicates a fault condition has occurred.

- Most common – failed or disconnected sensor
- Hardware failure (pre-amp)

If the sensor output is erratic: Make sure that the unit is in clean, ammonia-free air.

The unit has been factory zeroed and spanned. If the zero has become unstable, and there are no interference gases, the most likely problem is a faulty or aged cell, or a new cell with high gain left over from a previous cell that was adjusted for aging. If span calibration has not been performed with the new cell, turn span pot down (see Figure 7, Note 1), or counter-clockwise, 15 full turns. This will decrease the sensitivity and reduce the “jumpiness” of the new cell. Calibration is definitely required after this adjustment.

Electrical Interference: This sensor has been designed to be highly resistant to EMI/RFI using multiple stages of filtering and protection. However, in extreme environments, some noise pickup can occur directly through the sensor. Ensure that the bare shield wire of the instrument cable is connected to the terminal block marked *SHLD* at the sensor (not touching the metal enclosure) and properly grounded at the readout unit.

Interference Gases: The Manning EC-F9-NH₃ is designed to be quite specific to ammonia. However, some other gases can affect the reading. Phosphene, methyl mercaptan, and hydrogen can give a slight upscale indication. Bromine, ozone, fluorine, chlorine, and nitrogen dioxide can give a slight down-scale indication. Contact Honeywell Analytics if any of these gases are present in your application.

Figure 8. Troubleshooting

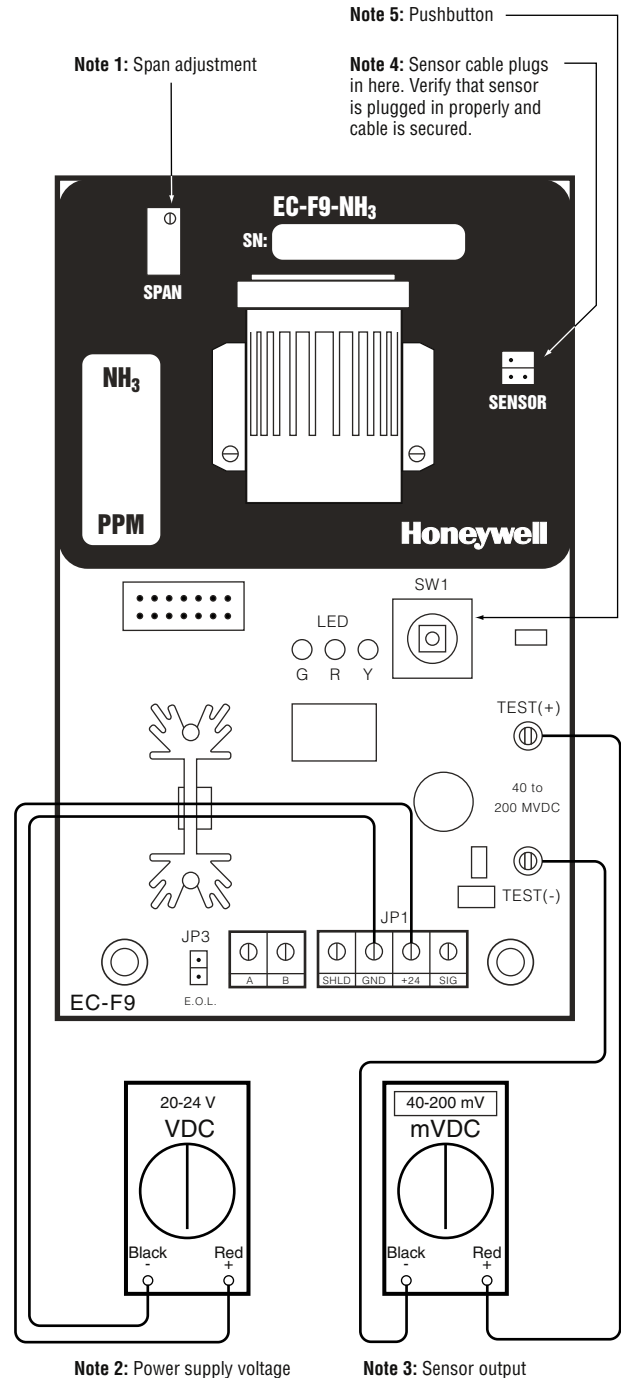

3 Operation continued

D Maintenance

For proper operation it is essential that the test and calibration schedule be followed. Honeywell Analytics recommends the following maintenance schedule:

- Calibration should be performed with certified calibration gas every six months or after major exposure to a leak. Calibration kits are available from Honeywell Analytics.
- Response test once between calibrations, i.e. at three month intervals. Expose sensor to ammonia/water solution to verify proper sensor response and alarm functions. Test more frequently in highly critical applications. The response test is not required if multiple electrochemical sensors are installed in the same room.

All tests and calibrations must be logged.

Sensor Life: These electrochemical cells are extremely reliable, but several things can cause the cell chemicals to become depleted including:

- a period of time,
- exposure to high temperatures,
- exposure to varying concentrations of the target gas,
- exposure to high moisture for extended periods without proper sensor enclosure.

CAUTION Although SensorCheck™ tests the sensor's electrical viability every 24 hours, it is absolutely essential that these units be exercised with a gas sample on a regular and timely basis.

Typical sensor life in a refrigerated area will be three to four years. Typical life in a non-refrigerated area will be one and a half to two years. Exposure to high levels of ammonia will shorten these times. In addition to timely response checks, a preventative maintenance program of periodic cell replacement should be implemented.

When the cell becomes depleted, a replacement cell can be obtained from Honeywell Analytics. Simply unplug the ribbon cable from the pins labeled Sensor, pull the old cell from the spring clip, discard the old cell and replace it with a new one.

The sensor should be checked according to the following procedure after a five-minute warm-up period.

EC Cell Replacement Procedure

- Remove the old EC cell.
- Plug in new EC cell, making sure connector pins are positioned correctly. Be sure ribbon cable is snug under plastic clip (see Figure 8, Note 4). 
- Allow cell to stabilize for five minutes.
- Perform manual SensorCheck™ using the procedure in the SensorCheck™ section.

Manning Systems' recommendation is to check calibration of all new cells with certified calibration gas. Follow procedure in Calibration section of this manual.

E Replacement Parts

For replacement parts, contact Honeywell Analytics. Be sure to give serial number of unit and model number.

4 Limited Warranty

1. Limited Warranty

Honeywell Analytics, Inc. warrants to the original purchaser and/or ultimate customer ("Purchaser") of Manning products ("Product") that if any part thereof proves to be defective in material or workmanship within eighteen (18) months of the date of shipment by Honeywell Analytics or twelve (12) months from the date of first use by the purchaser, whichever comes first, such defective part will be repaired or replaced, free of charge, at Honeywell Analytics' discretion if shipped prepaid to Honeywell Analytics at 405 Barclay Blvd., Lincolnshire, IL 60069, in a package equal to or in the original container. The Product will be returned freight prepaid and repaired or replaced if it is determined by Honeywell Analytics that the part failed due to defective materials or workmanship. The repair or replacement of any such defective part shall be Honeywell Analytics' sole and exclusive responsibility and liability under this limited warranty.

2. Exclusions

- A. If gas sensors are part of the Product, the gas sensor is covered by a twelve (12) month limited warranty of the manufacturer.
- B. If gas sensors are covered by this limited warranty, the gas sensor is subject to inspection by Honeywell Analytics for extended exposure to excessive gas concentrations if a claim by the Purchaser is made under this limited warranty. Should such inspection indicate that the gas sensor has been expended rather than failed prematurely, this limited warranty shall not apply to the Product.
- C. This limited warranty does not cover consumable items, such as batteries, or items subject to wear or periodic replacement, including lamps, fuses, valves, vanes, sensor elements, cartridges, or filter elements.

3. Warranty Limitation and Exclusion

Honeywell Analytics will have no further obligation under this limited warranty. All warranty obligations of Honeywell Analytics are extinguishable if the Product has been subject to abuse, misuse, negligence, or accident or if the Purchaser fails to perform any of the duties set forth in this limited warranty or if the Product has not been operated in accordance with instructions, or if the Product serial number has been removed or altered.

4. Disclaimer of Unstated Warranties

THE WARRANTY PRINTED ABOVE IS THE ONLY WARRANTY APPLICABLE TO THIS PURCHASE. ALL OTHER WARRANTIES, EXPRESS OR IMPLIED, INCLUDING, BUT NOT LIMITED TO, THE IMPLIED WARRANTIES OF MERCHANTABILITY OR FITNESS FOR A PARTICULAR PURPOSE ARE HEREBY DISCLAIMED.

5. Limitation of Liability

IT IS UNDERSTOOD AND AGREED THAT HONEYWELL ANALYTIC'S LIABILITY, WHETHER IN CONTRACT, IN TORT, UNDER ANY WARRANTY, IN NEGLIGENCE OR OTHERWISE SHALL NOT EXCEED THE AMOUNT OF THE PURCHASE PRICE PAID BY THE PURCHASER FOR THE PRODUCT AND UNDER NO CIRCUMSTANCES SHALL HONEYWELL ANALYTICS BE LIABLE FOR SPECIAL, INDIRECT, OR CONSEQUENTIAL DAMAGES. THE PRICE STATED FOR THE PRODUCT IS A CONSIDERATION LIMITING HONEYWELL ANALYTICS' LIABILITY. NO ACTION, REGARDLESS OF FORM, ARISING OUT OF THE TRANSACTIONS UNDER THIS WARRANTY MAY BE BROUGHT BY THE PURCHASER MORE THAN ONE YEAR AFTER THE CAUSE OF ACTIONS HAS OCCURRED.