



UPES-50D

Digital RS485 Multi-Channel Controller

Operating Manual



TABLE OF CONTENTS

Description of UPES Controller.....	2
Basic Specifications.....	4
UPES Device.....	5
Pre-Starting Procedure.....	7
Operating Procedure.....	8
UPES Display Information for Gas Detectors.....	10
UPES Display Information for Flame Detectors.....	11
Front Panel LED Indicators.....	12
Operating Mode Alarms of the Power Supply.....	13
UPES Installation Clearance Consideration.....	14
System Functionality.....	14
Device Search Options.....	15
Possible Malfunctions and Corrections.....	16
Description of the UPES Programming Tree Diagrams.....	18
UPES Menu in the Absence of the channel boards.....	18
UPES Menu with the Channel Boards Installed.....	21
UPES Channel Programming	22
UPES Channel Board Com-Ports Operation Mode Setting	25
UPES Channel Copy Settings.....	26
UPES Sensor Search.....	27
UPES Sensor Search by Address.....	29
UPES Sensor Search by Type of Sensors.....	31
UPES Sensor Search by List of Sensors.....	33
UPES Sensor Search by All Types (Automatic).....	35
UPES and PC Exchange Protocol.....	36
Power Cable Connection Diagram.....	48
Wiring Diagrams for Flame Detectors Connections.....	48
Wiring Diagrams for Gas Detectors Connection.....	49
UPES Markings.....	49
Transportation and Storage.....	50
Preventive Maintenance.....	50
Warranty.....	51

Description of UPES Controller

UPES-50D (hereinafter – UPES) is designed to operate with primary detectors via Modbus RS485 signals. The input signal exceedance of the set threshold levels is controlled by audible and LED alarms as well as connected peripheral devices via relay outputs for RS-485 interface transmission of all channel data in Modbus RTU protocol format.

UPES is installed outside the explosion hazard zones and shall be operated at temperatures from - 10 to 50 °C and relative ambient air humidity up to 95% at 35°C. UPES functional capabilities enable to power up to 16 primary detectors: SGOES, TGAES Rx, TGAES Tx, SSS-903, IPES IR/UV, IPES IR3.

The UPES multi-channel controller consists of a control panel capable of connecting up to 16X8 devices via RS485. From 1 to 128 devices can be connected to the UPES50D controller using Modbus RS485. The UPES controller can only provide power supply to no more than 16 primary detectors by itself at 24VDC each. If more than one device is to be connected to each channel card, an additional power supply will be necessary. The UPES can only power one device per channel. Each Channel of the UPES has 2 dry contact relays for the first alarm threshold and for the second alarm threshold. There is also a common dry contact relay for the third alarm threshold for all channels. All dry contacts relays provide current switch up to 2A at 220VAC.

Basic Specifications

Table 1. Basic Specifications

Relative humidity at temperature 35 °C, %	up to 95	
Ambient temperature range	from -10 up to +50 °C	
Input voltage range with various power supply units	power supply unit of BP-1 design	187-242 V 50 Hz (main power) or direct current with voltage 18-32 V (backup power)
	power supply unit of BP-10 design	130-242 V 50 Hz (main power) or direct current with voltage 180-340 V (backup power)
UPES power from DC power supply with voltage not more than, V	24	
UPES commutated current at AC voltage 220 V, A	up to 3	
Length, mm	266	
Width, mm	482	
Height, mm	132	
Weight, kg, not more than	17	
Ingress protection	IP54	

Fig. 1. UPES dimensions

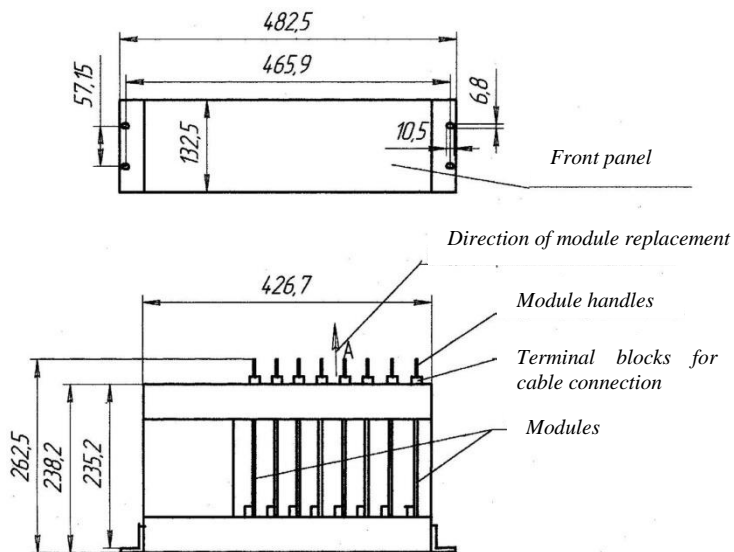

UPES control panel is designed as a standard 3U19"- type unit to be mounted in a rack

UPES Device

Fig.2. UPES Device

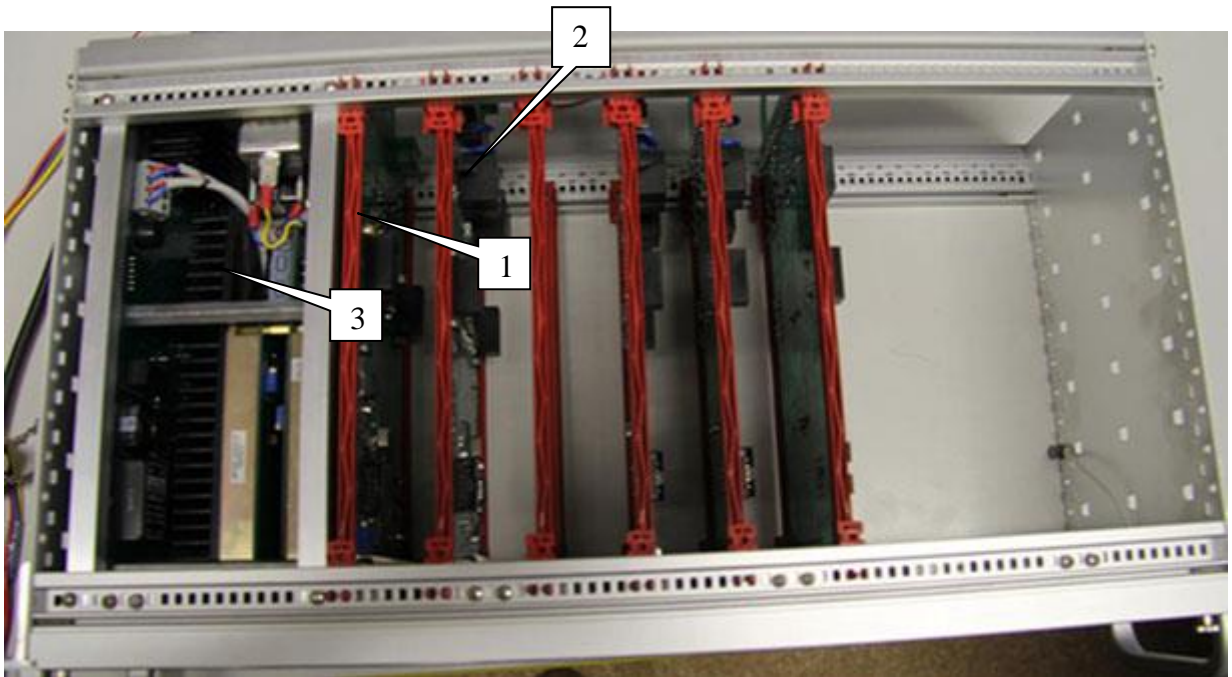

1. CPU board
2. 8 channel boards with 2 communications lines RS485
3. Power supply unit

Fig.2.1. Front View

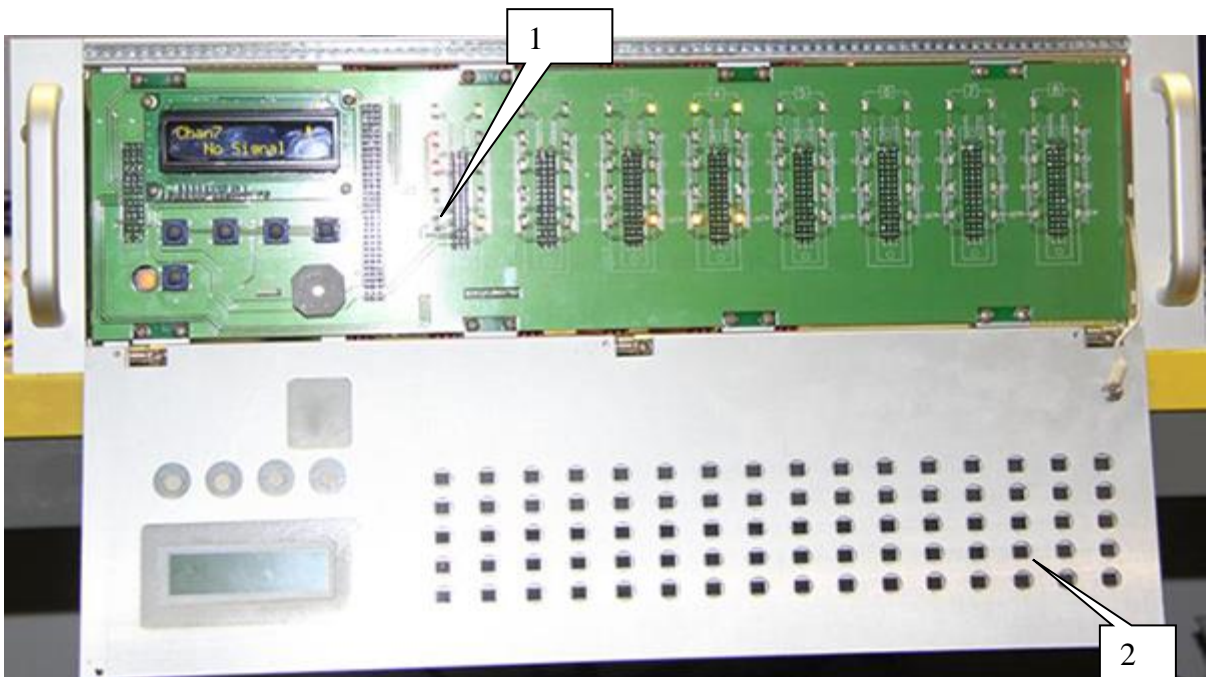

1. Interconnection board
2. Blind panel

Fig. 2.2. UPES Rear View

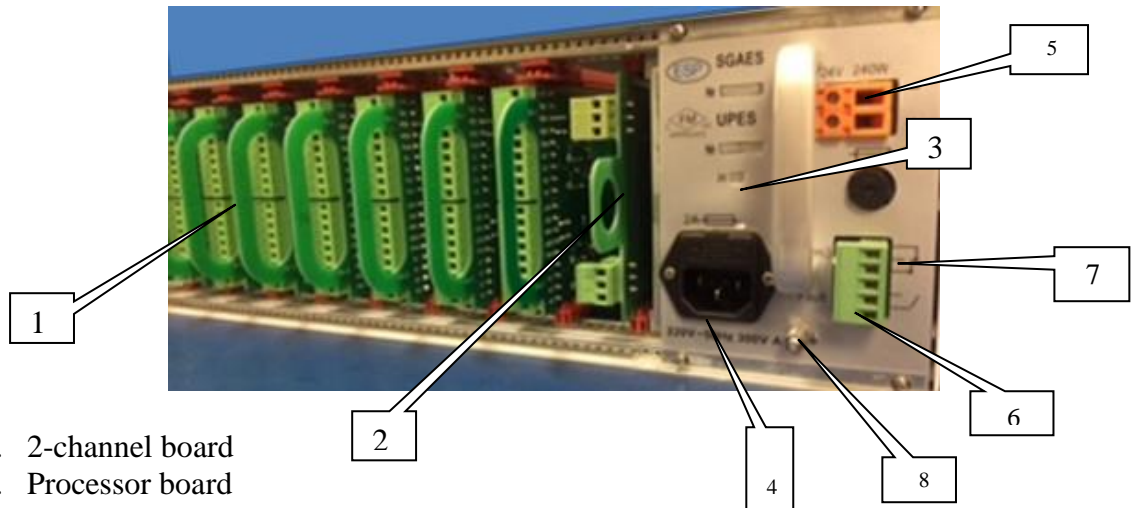

1. 2-channel board
2. Processor board
3. Power supply unit
4. Main power socket, 220V input voltage
5. Backup power socket, 220V input voltage.
6. Fault relay
7. Third threshold relay
8. Ground terminal

Fig.2.3. Interconnection Board

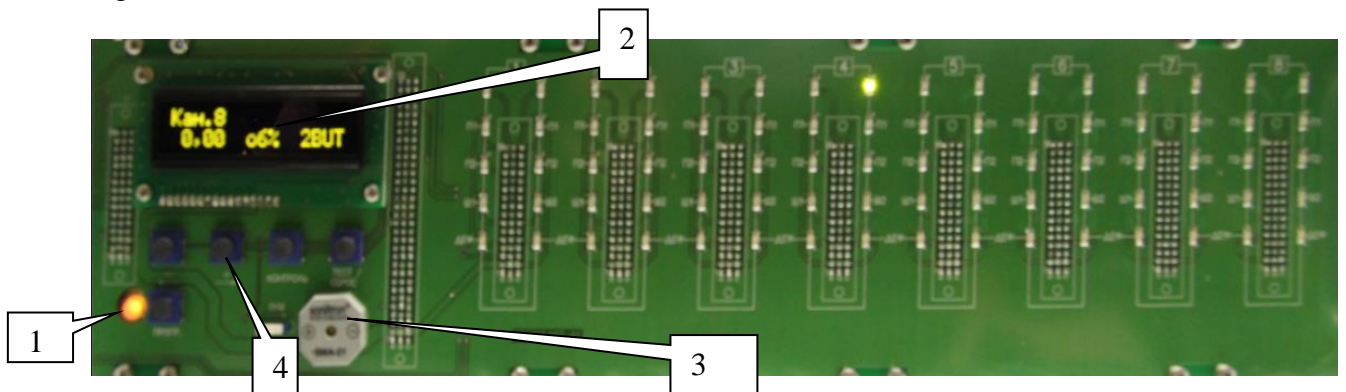

- | | |
|---|--|
| <ol style="list-style-type: none"> 1. UPES ON/OFF button 2. LED display | <ol style="list-style-type: none"> 3. Buzzer 4. Keyboard |
|---|--|

Each channel of the threshold device has a corresponding LED group:
 2 green – Activating +24V at the output of the module;
 4 red – exceeding specified thresholds;
 2 blue-status indication of the RS-485 bus lines;
 2 yellow – indication of sensor malfunction.

Moreover, in case of concentrations of any threshold of any channel are exceeded, an audible alarm, which is built in UPES, is activated.

Pre-starting Procedure

Prior to installation it is necessary to perform visual inspection. Pay attention to the following:

- 1) signs of damages;
- 2) availability of all fixture elements;
- 3) Availability of grounding devices.

Installation shall be performed in accordance with a duly established project of onsite allocation pursuant to the installation diagram with due account for threshold device design. When performing installation, consider the following:

- 1) Local Electrical Installation Regulations
- 2) Local Safety Regulations on Consumer Electrical Installation Operation;
- 4) This Operating Manual.

In order to connect UPES to a personal computer via RS-485 communication channel, it is possible to use any shielded twisted pair cables. In this case, signal wires are connected to contacts "485A" and "485B", and the shield is connected to contact "GND", located at the terminal block on the controller module rear side. In order to connect UPES to the network and external actuation and signaling devices, it is possible to use any cables, cords or wires rated for operational voltage and current specified in this OM.

UPES shall be grounded by means of a screw clamp located at the bottom of the power unit rear wall. Upon completion of installation, check the following: - insulation resistance, which shall be not less than 0.5 MOhm; - grounding device resistance, which shall be not less than 4Ohm. When installing UPES, provide free space above and under it in a rack with height not less than the threshold device height (132 mm)

Operating Procedure

Each of the eight channel modules can communicate with sensors by two RS-485 lines with MODBUS addresses from 1 to 16, and transmit information to the central processor unit (CPU) on the concentration and the state of each of the sensors.

The sensors are connected to the module via two separate lines or in a "ring" in accordance with the requirements of the project. The module supports connection of up to eight sensors on each RS-485 line and provides power supply for one sensor for each channel. When you connect to UPES more than 16 sensors, they must be fed from a separate power supply of + 24V.

- **One port** — communication with sensors via an independent port, 16 sensors (MODBUS address from 1 to 16) can be connected to the port. The state of the sensors connected to the port is displayed on the first relay set;
- **Hot swap** —communication with the sensors through the first port. In case of failure of the first port communication is transferred to the second port (MODBUS address from 1 to 16). When you activate the first port the communication is restored in the initial mode;
- **Ring** — communication with sensors via the first port, where the ring integrity is controlled. When the ring is open, communication between the primary transducers is performed via two ports (MODBUS address from 1 to 16);
- **Two independent ports** — communication with the sensors via two independent ports, 8 sensors can be connected to each port. The state of the sensors connected to the first port is displayed on the first relay set and the state of the sensors connected to the second port — on the second relay set. The first MODBUS port: 1-8, the second MODBUS port: 9-16.

The module has two relays on the output with "dry" contacts (relay of first and second threshold) for each channel.

The boards generate the signals for L3 threshold and Fault relay that are common for all UPES, the "Fault" LEDs lit up individually for each board of the connected primary transducers of the RS-485 lines, in case of the sensor failure. Two-channel boards have LED status indication of the RS-485 lines and continue their work in the absence or failure of the CPU. The channel module at first-time start-up receives from the CPU the internal number, in accordance with the location in the UPES enclosure.

For each primary detector the user assigns the MODBUS addresses which are connected to odd (1-8) and to even (9-16) channels. The CPU remembers the numbers of the boards and the MODBUS addresses of the sensors connected to each port and when the power is turned off or lost (failed) recovers the device configuration. To search for sensors and system initialization assign MODBUS addresses to the sensors from 1 to 16 for each channel board.

The CPU controls the entire block, display, transfers the RS-485 information to the "top level" on concentration and the state of each of the sensors connected to each channel board. CPU is controlled with the keyboard, located on the front panel, as well as using the command and address registers from your PC.

When you enable the UPES the "test mode" starts, in which the front panel LEDs start flashing alternately.

After pressing the "Control" button or in 30 seconds channel modules begin checking the RS-485 lines and consecutive scanning of sensors in accordance with the set MODBUS addresses. When it detects information about gas concentration exceeding the threshold, the priority scanning of this sensor is performed and the information is displayed on it, it immediately turns on threshold LEDs and the threshold relay with the set delay.

NOTE:

It is NOT possible to connect on single-sensor-board gas detectors and flame detectors, including working on different channels of one card in mode 2 port.

Work algorithm:

1) Connect the device 1 IPES - fire detection trigger two alarm thresholds. Lights up on the display «Fire»

2) connect the 2 devices and more IPES -

- If a fire one device triggered 1 alarm threshold settings and displayed on the display the inscription «Attention»;

- When processing with two or more triggers 1 and 2 the alarm threshold, the display you-usual inscription «Fire»

UPES Display Information for Gas Detectors

The display shows the following information: gas detector

1	2	3	4	5	<u>for SGOES</u>									
/	/	/	/	/										
C	h	a	n	1	-	1	0	o				1	5	
1	0	0	.	0	0	L	E	L	↑	↑		P	R	O
6	7	9	8											

1 /	2 /	3 /	4 /	5 /	<u>For TGAES Rx (receiver)</u>











C	h	a	n	1	-	7	o				7		
	0					L	E	M			C	H	4
6	7	8											

C	h	a	n	1	-	8	o				8			<u>For TGAES Tx (transmitter)</u>
		S	o	u	r	s	e				T	G	A	

-
- 1-channel;
 - 2 - serial number of the channel board
 - 3- serial number of the sensor connected to the channel board
 - 4 - operating mode of the channel board o- "ring", ↵" hot swap", -"two independent channels", - "one channel".
 - 5 - MODBUS address of controlled sensor;
 - 6 - gas concentration;
 - 7 - measurement units;
 - 8- measured gas type;
 - 9 – actuation alarm of one (↑) or two thresholds (↑↑).

Front Panel LED Indicators

The front panel contains LEDs of each of the eight channel modules:

- | | | | |
|-----|---|---|--|
| 1 - |  |  | green LEDs indicating turning on of + 24V at the output of the channel |
| 2 - |  |  | red LEDs indicating the 1-st threshold |
| 3 - |  |  | red LEDs indicating the 2-st threshold |
| 4- |  |  | blue LEDs indicating the RS-485 bus lines state |
| 5- |  |  | yellow LEDs indicating the sensor faults |

RS-485 bus line state indication LEDs are turned on at the time of receipt of request from the channel board to the sensor and are turned off at the time of the receipt of the correct answer from the requested sensors or upon the expiry of the set time of waiting for a response from the sensor.

Light up of one of the "Fault" LEDs indicates a failure of one of the sensors in the bus line, or the absence of response from one of them within the prescribed period of time.

At the back of the UPES there are screw terminal connectors to connect the bus lines from sensors and cables from the external actuation devices (fans, valves, buzzers, etc.). There are also mount hole for connecting the network and backup power supply and link with PC through RS-485 communication channels.

Structurally, the UPES is a unified frame in size of $3U \times 19$ " ($482 \times 266 \times 132$ mm) built in accordance with the bus structured and modular approach. In the frame there is a power supply module, CPU module and up to eight two-channel modules. The power supply provides a relay switch of main supply to 24 VDC reserve power supply.

In the power supply the primary main power supply takes precedence over the primary reserve power supply for the detector. In the absence of $\approx 220V$ 50 Hz or in case of the failure of the primary main power supply, the power supply unit ensures smooth transition to the reserve supply, generating a sound signal and light indication on the UPES front panel (built-in red and green LEDs in the UPES power buttons).

UPES is switched ON by continuous (2 sec) pressing on the power button on the front panel of the device after the feeding of the primary and reserve power supply.

The power supply unit controls voltage outputs of primary power supply transducers and ply and current consumption from them, compliance with the predetermined voltage limits of all the reserve power supplies. Overrun of predetermined parameters is signaled by red light indication on the UPES front panel, as well as sound signals with a simultaneous 24 V supply voltage dump.

The power supply monitoring system has a separate secondary power source and a 5 V back-up source with estimated operating time up to 30 seconds.

Flashing LEDs illuminating buttons in any color with a frequency of 1 Hz indicates that the power supply is switched off.

- Flashing red button illumination with a frequency of 1 Hz indicates that the power supply is switched off due to fault in the power supply or overloading of secondary power sources.
- Flashing LEDs illumination button (yellow) with a frequency of 1 Hz indicates that the power supply is turned off, but one of the input voltage (backup or primary) is absent.
- Continuous illumination of LED buttons (any color) indicates that the power supply is turned on.
- Continuous illumination of LED button (yellow) indicates that the power supply is turned on, but one of the input voltage (back-up or primary) is absent, when the power supply switches from the back-up source short signals with a frequency of 1 Hz are generated.
- Continuous illumination of LED buttons (green) indicates that the power supply is turned on and all input voltages are connected (back-up or primary).

In all modes, connection or disconnection of any input voltage is indicated by the single sound signal for 1 second.

Operating Mode Alarms of the Power Supply

Indication Mode	UPES Power Supply
Intermittent green illumination of the UPES power button	UPES is not turned on, all input voltages are connected
Intermittent yellow illumination of the UPES power button	UPES is not turned on One of the 220V input voltages is absent
Steady green illumination of the UPES power button	UPES is turned on. Supply voltage, the primary and back-up are connected and normal. Output voltage of primary transducers-OK. Output voltage of secondary transducers-OK.
Steady yellow illumination of the UPES power button Generation of short signals once a second	UPES is turned on. Powered by redundant power supply 220V.
Steady yellow illumination of the UPES power button There are no sound signals	UPES is turned on. Powered from the main source 220V

The main and back-up supply in UPES has no commutation through switches, so the power supply shall be connected to UPES through an external switching device.

The gas analyzer can also be connected with external devices with the cable for the industrial interface RS-485, RS-422 (4 twisted pairs) cable with armor in the form of corrugated steel can be used in hazardous areas.

To connect the UPES to the PC via the RS-485 communication the shielded twisted pair can be used.

The external grounding conductor shall be thoroughly cleaned, and its connection with the external grounding clamp shall be protected from corrosion by applying lubrication grease.

The control panel shall be grounded with a screw clamp located at the bottom of the back wall of the power supply unit.

At the end of the installation it is required to check:

- insulation resistance, that shall not be less than 0.5 MOhm;
- resistance of the earthing device, that shall not be more than 4 Ohm.

UPES Installation Clearance Consideration

When installing the control panel in a rack there shall be empty space above it and below it that shall be at least the height of the control panel (132 mm).

System Functionality

Connect the UPES to the detectors and verify its functionality.

For this purpose it is required to release two screws at the top of the front panel of the device, unscrew the front panel and press ON.

After switching ON the UPES, the central board processor determines whether channel cards are available. The ("Initializing channels") appears on the display (Fig. 1).

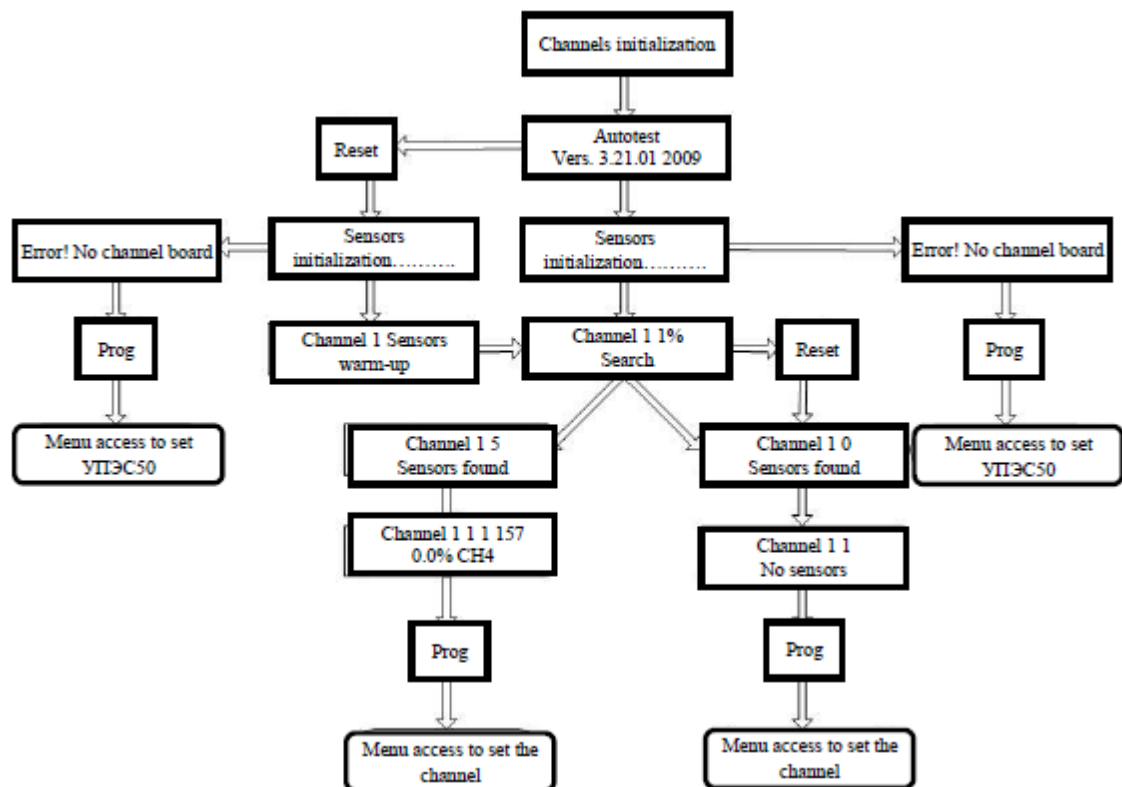

Figure 1. Cyclogram of the messages displayed on the display when UPES is initialized

When the search for the channel boards is complete, the test program is initiated. The ("Autotest Elektronstandart-Pribor") message is displayed on the display in the top row as a crawl line, and in the bottom line the software version and year of manufacture is displayed. LEDs of the channel cards initialized flash on alternately. In 30 seconds testing stops. Autotest can be interrupted by pressing the ("Test") button.

Search Options

If the central board has not found any channel card, the ("Error! No Channel card") message appears on the display.

The central board controller transmits the search command to the channel boards sensors connected. The central board controller alternately scans the search condition of each channel card. If the UPES autotest has been interrupted by pressing the ("Test") button, the channel boards expect sensor initialization for 20 seconds, and in this case the indicator in the bottom line displays the ("Sensors Warm-up"), and in the top line the number of the channel card connected is changed alternately. After the channel card has completed waiting for warm-up, the sensor search program starts. If in the channel card memory the MODBUS addresses and sensor types have been recorded, the channel card controller searches for sensors per this list, otherwise the search is performed by screening all sensor types in the MODBUS addresses from 1 to 16. The status of the search for each channel card is displayed alternately on the display. The top line displays the channel number and the search percentage completion, and in the bottom line displays the search mode:

- ("Search") search all types of sensors in all the MODBUS addresses from 1 to 16
- ("Address search") search sensors in the MODBUS addresses specified by the operator;
- ("Search by type") — search sensors by the types of sensors specified by the operator:
 - SSS —SSS-903, gas analyzer,
 - SGO — SGOES-M11, SGOES gas analyzer,
 - FRE – IPES fire detector,
 - PGU —primary universal transducer,
 - SSM – CCC-903ME gas analyzer.
 - TGA – TGAES gas analyzer
- ("Search per the list") search sensors by the MODBUS address specified by the operator and sensors corresponding to its type.

The channel card controller having found all the sensors, will display the number of the sensors found during the next search state scan performed by the central board. The indicator for this card will display the channel number and number of sensors in the top line and in the bottom line — the ("Sensors Found") message. The central board controller will scan the search status of each channel board until all boards have completed their sensors search. The channel board controller having completed the sensors search automatically enters into the scan mode for the parameters modified by the sensors and thresholds state monitoring.

Once all the channel boards have completed the sensors search program, the central board controller prompts for the MODBUS addresses of each channel board, types of the sensors found, gas codes, and units of measurement. Having received this information, the central board switches to the scan mode of the measured parameters and the sensors monitoring mode. If the

channel board has not found any sensor, the UPES indicator in the bottom line for this channel board will display the (“No sensors”) message.

Working with the UPES menu, channel programming , modes setting in various device configurations, and all the modes are given in the tree diagrams in the next pages.

Possible Malfunctions and Their Corrections

Possible malfunctions and their correction is described in Tables 6 and 7.

Table 6

Fault	Possible Reasons	Correction
The channel does not appear on the display, LEDs are not lit	No supply voltage. Faulty rail fuses. Backup power circuit fault.	Replace rail fuses, installed inside the plug on the back of the power supply unit (2A, 2 units). Replace the fuses (12.5A, 2 units), mounted on the back of the power supply unit
Yellow LED is lit continuously	Communication line failure. Faulty wire	Restore the line. Repair or replace the wire
The LED is not lit when the sound alarm and relay trigger	The LED is faulty	Replace the LED. The authorized specialist shall perform this operation.
The threshold is exceeded, but external devices are not switched on	The relay is faulty Damaged external communication lines	Consult with the manufacturer's specialist. Repair the corresponding module. The authorized specialist shall perform this operation. Fix damage

Table 7. Power Supply Unit Fault Alarm

Fault	Possible Reasons	Correction
The UPES power button is intermittently lit in red, the intermittent sound signal is generated. UPES is switched ON	UPES is switched off Malfunction or overload of one of secondary power supplies	Press and hold the UPES power button for 2 seconds If the situation repeats: 1. Check the correct installation of the sensors. 2. If there are no doubts in correctness of installation, see. p. 3. 3. When the power is off remove all boards from UPES, in case of repeated emergency after switching on, the unit shall be repaired
The UPES power button is intermittently lit in red UPES does not switch on	Malfunction or overload of one of secondary power supplies	Unit repair

Fault	Possible Reasons	Correction
Short-term red flashes of the UPES power button, short beeps UPES does not switch on	All input voltage 220V is lost when the UPES has already been on	Connect the power supply to UPES
Short-term red flashes of the UPES power button, no sound signals UPES does not switch on	All input voltage 220V is lost when the UPES has already been off	Connect the power supply to UPES

Description of the UPES Menu with Tree Diagrams

The UPES menu in the absence of channel boards

Depending on the UPES state, availability of channel boards, availability and condition of sensors there may be various menu items. In order to enter the menu, press the ("Prog") button.

If there are no channel boards in UPES, there is only one menu for setting —("UPES Programming") (Fig.T1).

In this mode, the UPES only the interface language, the exchange rate with the top-level system, and UPES MODBUS address can be set.

To configure the interface language use the ("Prog") button to select "Language" and the "+" and "-" buttons to select the desired language and press the ("Test/Enter") button. To exit from any menu item without setting the selected value by press the ("Control/Exit") button.

To set the UPES exchange speed with the top-level system, select the button ("Prog") button of the ("Exchange rate") menu and use the "+" and "-" buttons to select the desired exchange rate. The following exchange rates are possible with the top-level system: 4800, 9600, 19200, 57600 baud. To save the set exchange rate, press the ("Test/Enter"), and the selected value will be in the square brackets.

To set the UPES MODBUS address in the top-level system select the (Modbus address) menu. The available range of addresses to set is from 1 to 247. Select the address required with the «+» and «-» buttons. Select and press the «+» or «-», to move the Modbus addresses faster. For the selected address to be set and recorded in the controller memory, press the ("Test/Enter") button, the selected Modbus address value will be in square brackets.

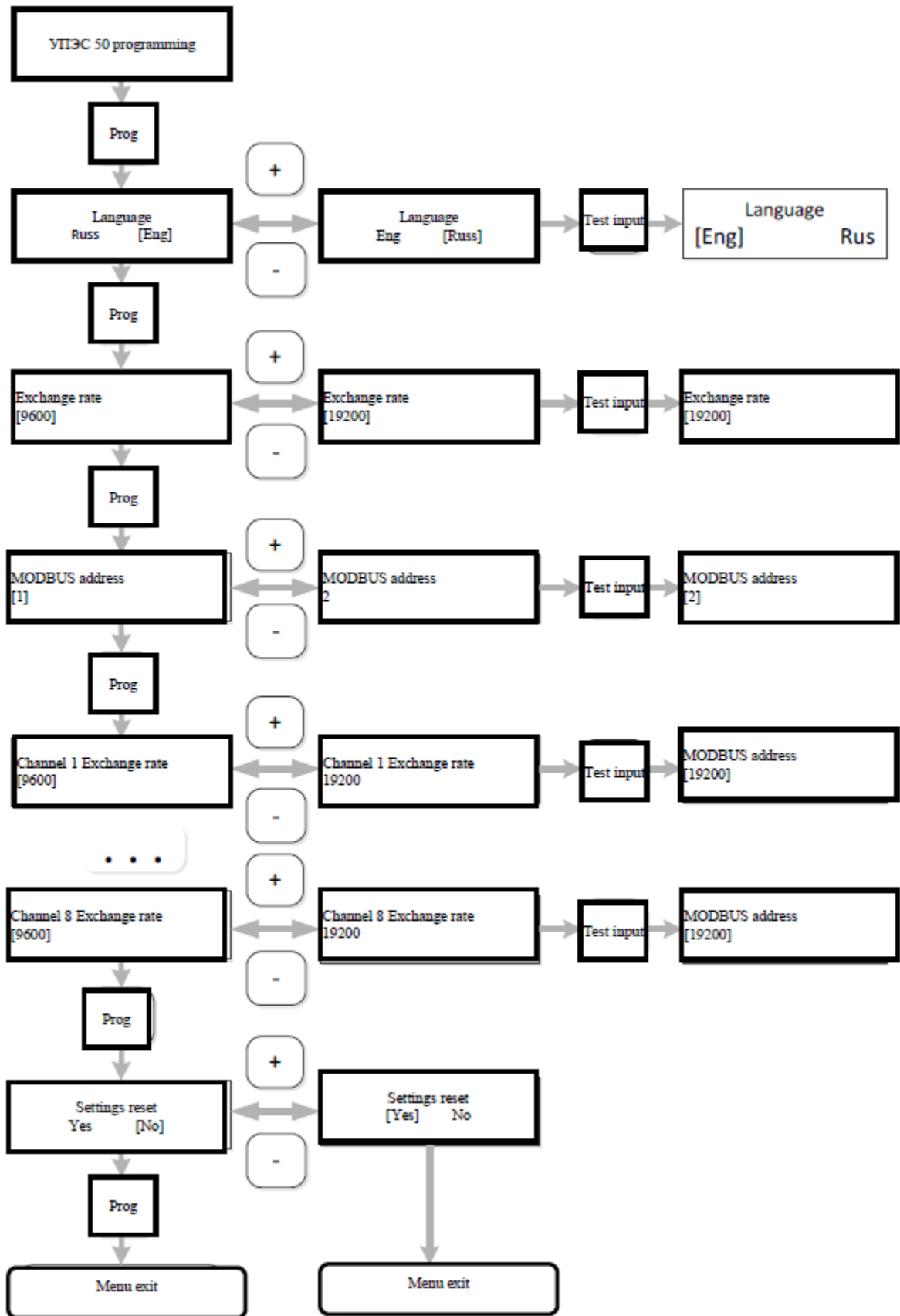

Figure T1.

To reset the UPES settings, select the (“Reset Settings”) with the "+" and "-" buttons to select ("Yes") and press the ("Prog") button. The UPES settings will be set to their default values. By default, UPES has the following settings:

- Interface language is English;
- Exchange rate is 9600 baud.
- Modbus address — 1;
- Exchange rate between the channel boards and primary detectors — 9600 baud.

The UPES setup menu is similar to the menu when there are no channel boards (fig. **Error! Reference source not found.**), except that if there are channel cards, the menu items related to exchange rate setting of the channel boards are added.

The exchange rate between the channel boards and the sensors is set similarly to the speed UPES exchange rate with the top-level system.

The exchange rate between the channel boards and primary transducers — 2400/4800/9600 (default)/19200 baud. The exchange rate for the channel card is set for both ports.

UPES menu with the channel boards installed

During UPES normal operation (channel boards installed) you can enter the menu by pressing the ("Prog") button, and the channel boards and sensors connected to the channel boards setup menus will be available for the channel board whose number is displayed in the top line of the display during the normal operation mode.

If you want to select the setup menu for the channel board with a different number from the one that appears on the display, using the "+" and "-" buttons select the desired channel board number, and then press the button ("Prog").

The main UPES menu items are shown in Figure T2.

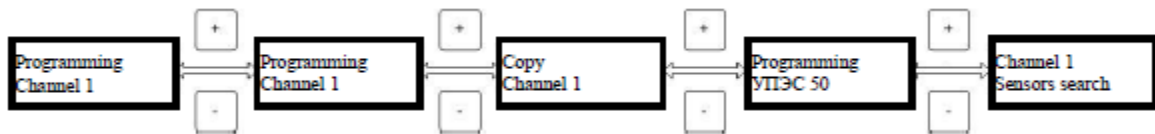

Figure T2.

To switch between press the "+" and "-" buttons to select the desired menu item, and then press the ("Prog") button.

Channel programming menu

To set the parameters for the channel board select the desired channel board with the "+" and "-" buttons and press the ("Prog") button.

When you enter the main menu ("Programming x Channel"), where x is the number of the selected channel, press again the ("Prog") button, then you get into the channel board setup menu (fig. T3)

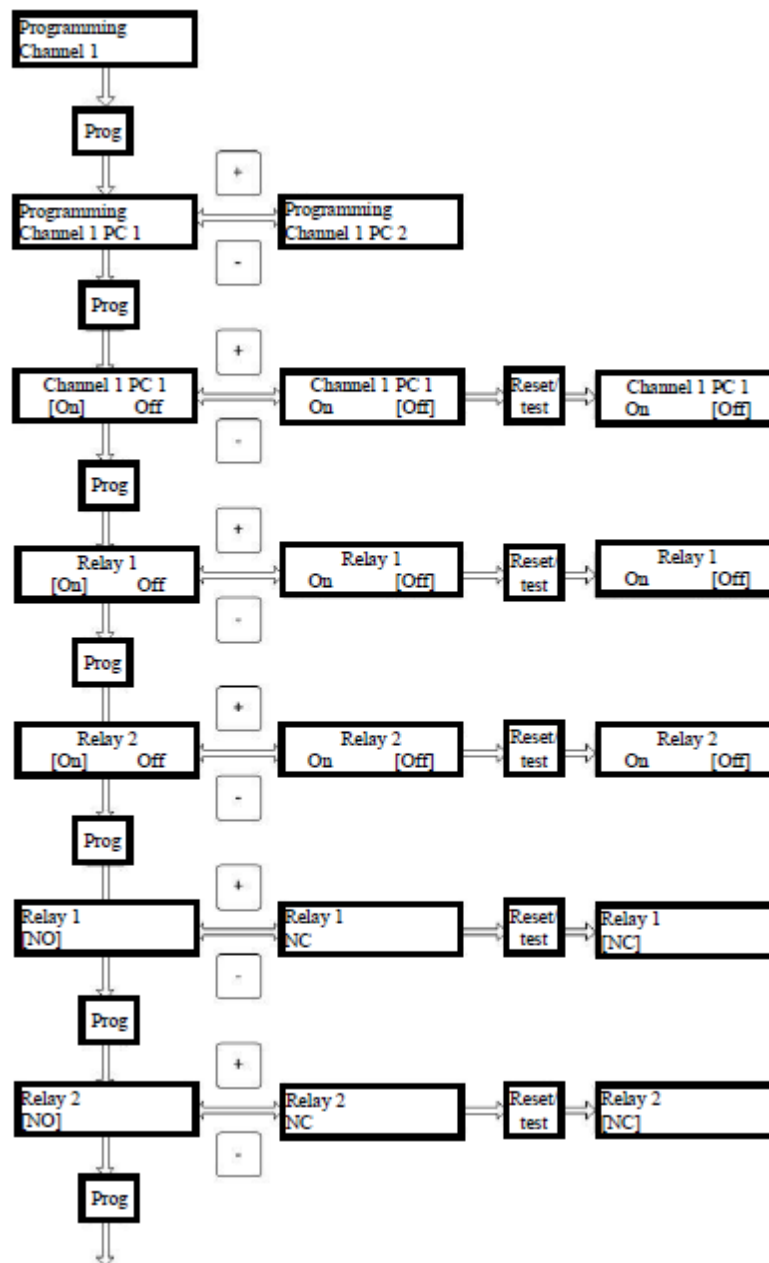

Figure T3

In the channel board there are two sets of relays — 1 and 2 of the threshold. When connecting the channel board with the sensors in the two independent ports mode, the first set of relays is linked to the sensors connected to the first port, the second set of relays is linked to the sensors connected to the second port. In all other operating modes, the first

relay set is associated with all connected sensors, the second relay set works only in the "ring" mode (in the event of the bus line failure).

In the hot swap mode in case of failure of the first port all the sensors work with the first relay set and the scan is performed from the second port.

To select the edited relay kit, select (Programming Channel x Comp. 1), where x – is the number of the channel being edited. To select the second relay set, press the "+" or "-" button and the menu (Programming channel x Comp. 2) will appear. Select the set required and press the ("Prog") button.

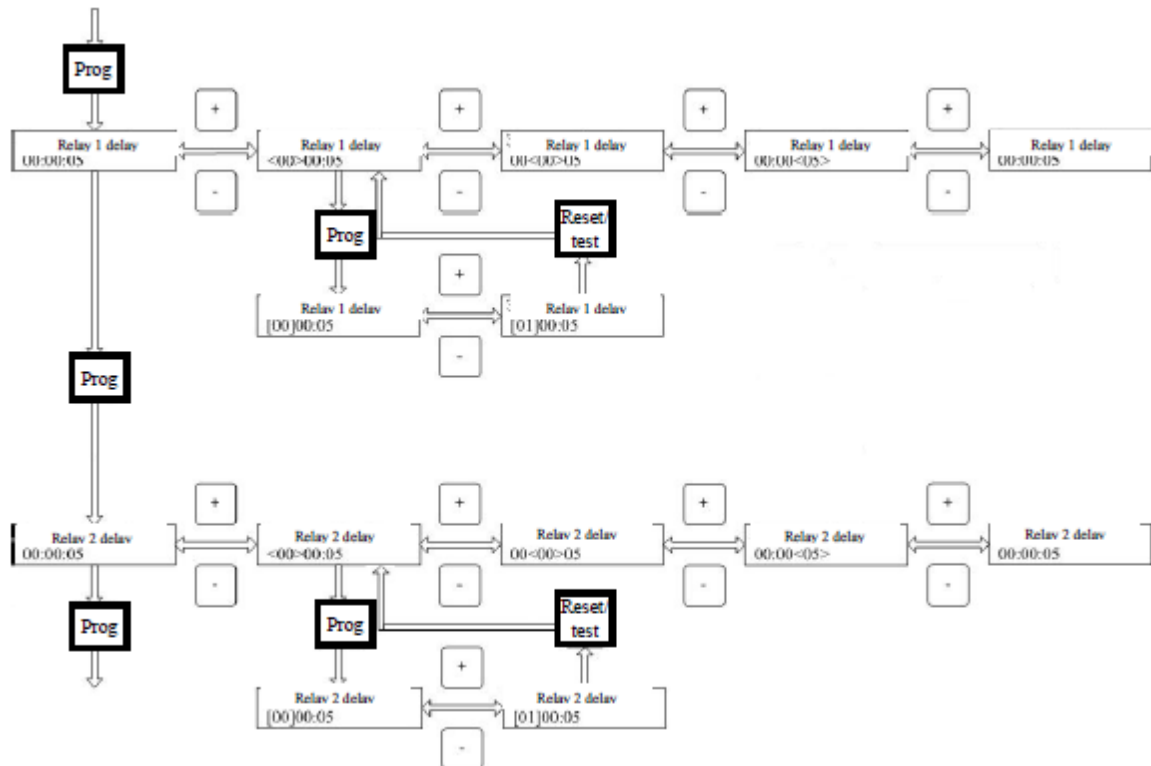

Figure T4

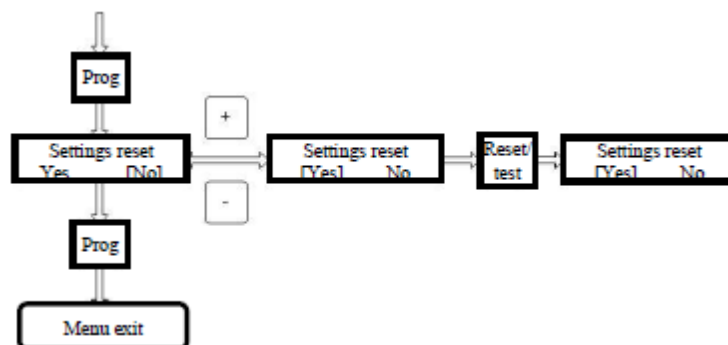

Figure T5

When you reset the settings, the 2-channel board has the following settings:

- The channel is enabled;
- The first relay threshold is enabled;
- The second relay threshold is enabled;

- The first relay threshold is normally open;
- The second relay threshold is normally open;
- The first relays triggering delay is 5 seconds;
- The second relays triggering delay is 5 seconds;

Enable or disable the relay set selecting the menu ("Channel x Comp. u On [off]"), where x is the channel number, u is the number of the set. With the "+" or "-" buttons select ([on]), if you want to enable, and ([off]) if you want to disable the set. When the set is disabled, there is no power on the output terminals of this set.

The (Relay 1 [On] Off) menu and ("Relay 2 [On] Off") menu enables and disables the relay of the first and second threshold respectively. If the relay is enabled, the relay is enabled too when the corresponding threshold in the sensor is achieved. If the relay is disabled, it will not trigger when the threshold in the sensor is achieved. For the selected menu item to be saved in memory, press the ("Test/Enter") button.

The (Relay 1 [NO]) menu and the (Relay 2 [NO]) sets the relay status in the absence of the flag of the first and the second sensor threshold achieved. The following relay states are possible: normally open and normally closed. To select the appropriate state, select the state with the "+" and "-" buttons and press the ("Test/Enter") button.

When the sensor threshold is achieved, the relay delay triggering can be set by the appropriate threshold, to do so it is required to select (Relay 1 delay) or (Relay 2 delay). The maximum relay triggering delay is 12 hours. The delay time is set separately: hours, minutes, seconds. When you set the relay delay the maximum relay delay period is controlled, i.e. if the minutes are set to 59, the hours cannot be set to more than 11. To set the relay delay period with the "+" or "-" buttons select the time units edited (fig T4**Error! Reference source not found.**). The time units edited are in < > parentheses. To edit the selected units, press the ("Prog") button the < > brackets will become square brackets []. With the "+" or "-" buttons set the desired value and press the ("Test/Enter") button, the brackets of the editable time units will turn to < > again, press the "+" and "-" buttons to switch to the following time units and repeat the setting procedure. To exit the relay delay time setup menu press the "+" and "-" buttons to adjust any of the units of time so that there are no triangular brackets < >. After that switch to the following menu item, by pressing the ("Prog") button.

In ("Settings Reset") menu, you can reset the settings of this set to the default state. To do this, with the "+" and "-" buttons select the (Yes) menu item and then press the (Test/Enter) button and the ("Prog") button to exit the menu.

Channel Board COM-Ports Operation Mode Setting Menu

The (Connecting Channel x) menu, where x – is the number of the channel edited, allows you to configure the channel board COM-ports operation mode (Fig.T6).

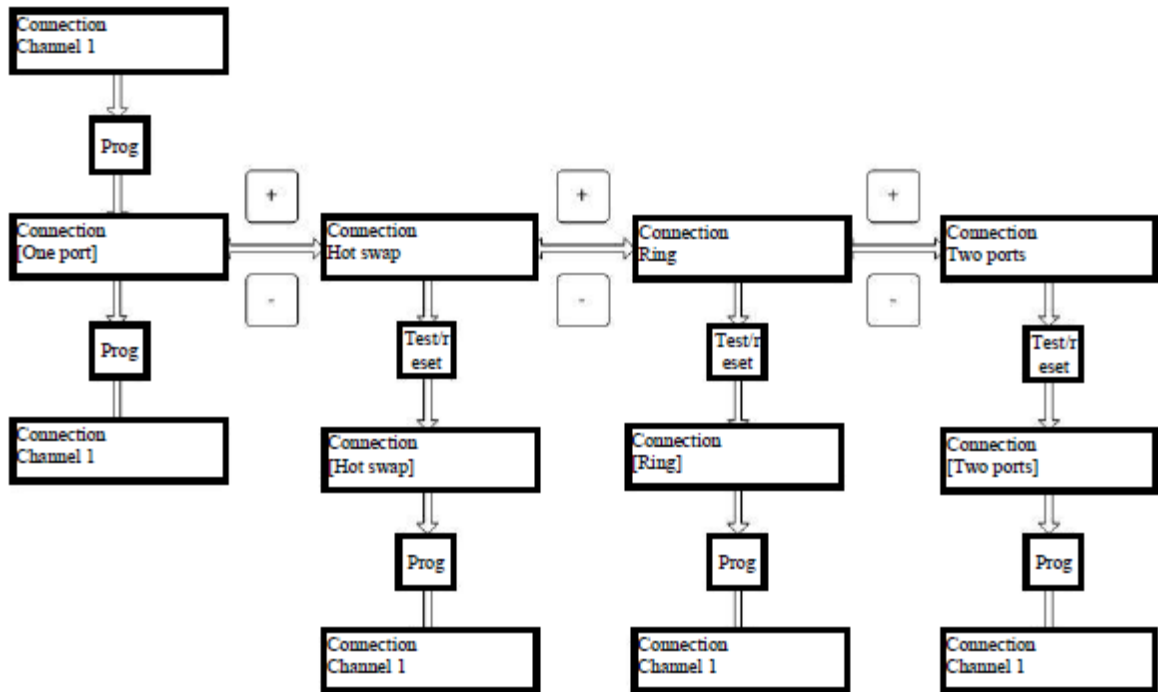

Figure T6

In the channel board the following COM ports operation modes are available:

- **One port** — communication with sensors via an independent port, 16 sensors (MODBUS address from 1 to 16) can be connected to the port. The state of the sensors connected to the port is displayed on the first relay set;
- **Hot swap** —communication with the sensors through the first port. In case of failure of the first port communication is transferred to the second port (MODBUS address from 1 to 16). When you activate the first port the communication is restored in the initial mode;
- **Ring** — communication with sensors via the first port, where the ring integrity is controlled. When the ring is open, communication between the primary transducers is performed via two ports (MODBUS address from 1 to 16);
- **Two independent ports** — communication with the sensors via two independent ports, 8 sensors can be connected to each port. The state of the sensors connected to the first port is displayed on the first relay set and the state of the sensors connected to the second port — on the second relay set. The first MODBUS port: 1-8, the second MODBUS port: 9-16.

To set the channel board communication mode, select ("Connecting Channel x") and press the ("Prog") button. Use the "+" and "-" buttons to select the desired communication mode and press the ("Test/Reset") button. To exit the menu, press the ("Prog") button and then press the ("Control") button to exit the main menu.

Channel Settings Copy Menu

In UPES, it is possible to copy settings of the sets of channels. To do this, select the (Copy channel x) (Fig T7).

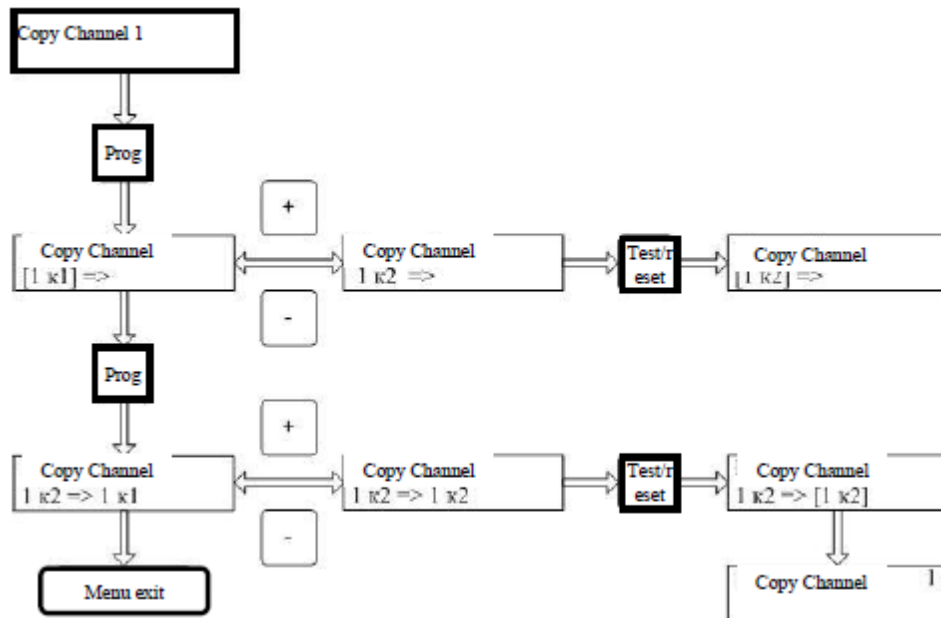

Figure T7

In this menu it is possible to copy the settings of the first or second channel x sets in any other set and channel from the system. Press the ("Prog") button in the (Channel copy) menu and use the "+" or "-" buttons to select which of the sets you want to copy and press the (Test/Enter) button.

Then press the ("Prog") button and you will enter the set selection menu where to copy the settings. Use the "+" or "-" buttons to select the desired channel and the desired set and press the (Test/Enter) button. Once the data have been copied to the channel board, the central processor controller will automatically revert to the beginning of the menu (Copy Channel x).

When copying the following channel parameters are copied to the copied channel:

- 1) Activation of the channel "on/off";
- 2) Relay first and second threshold status NO/NC ("Relay 1", "Relay 2");
- 3) Relay delay time.

Sensor Search Menu

To search for sensors and control list of the sensors connected to the channel board open the ("Channel x Sensor Search") menu (see fig T8).

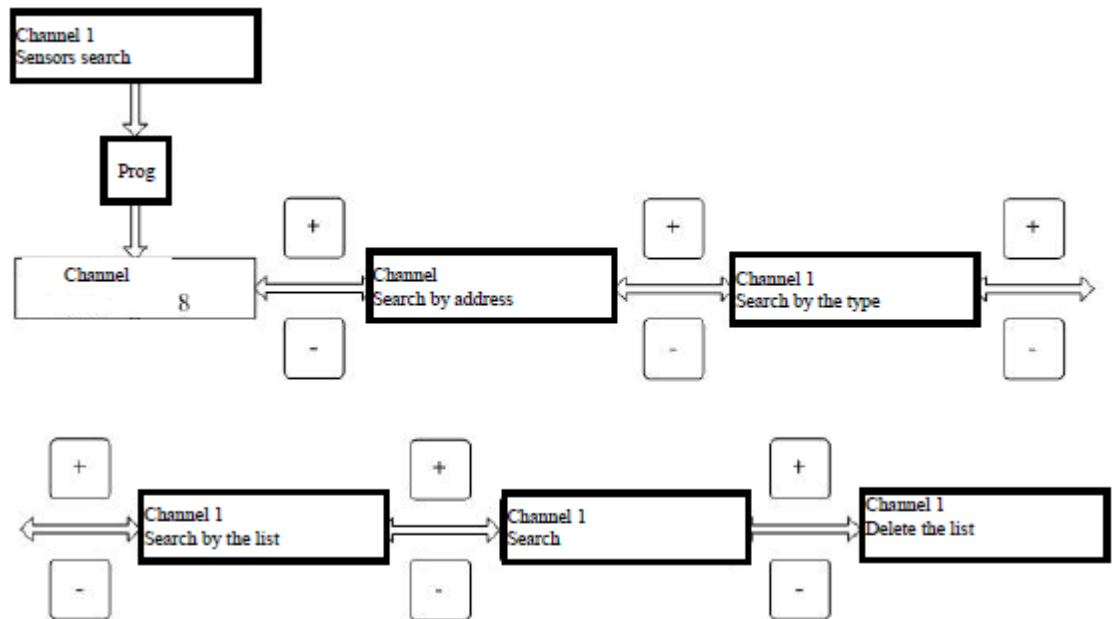

Figure T8

In this menu you can set the sensor search by the known address (address search), type (search by type), address and type (search by the list) or simply search (Auto search), as well as erase the list of sensors in the channel board.

Erase the list of sensors in the channel board by selecting the "+" and "-" buttons in the ("Channel x" list removal) (figure T9) and press the ("Prog") button.

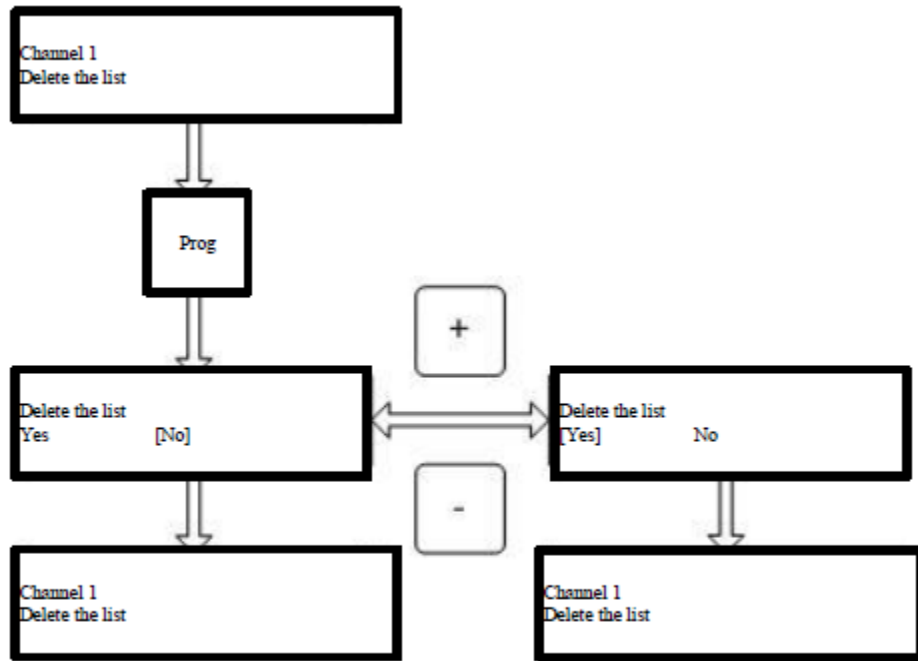

Figure T9

Use the "+" and "-" buttons, select ("Yes") and press the ("Prog") button. The data about the sensors will be deleted from the channel board memory and the central boards controller will return to the menu title. All the thresholds, communication failure flags are reset. The channel board will switch to operation without sensors.

Search for Sensors by Address

The sensors in the channel board can be searched for by the known address. To do this, use the "+" and "-" buttons to select the (Channel x search by address) menu item (fig. T10) and press the ("Prog") button.

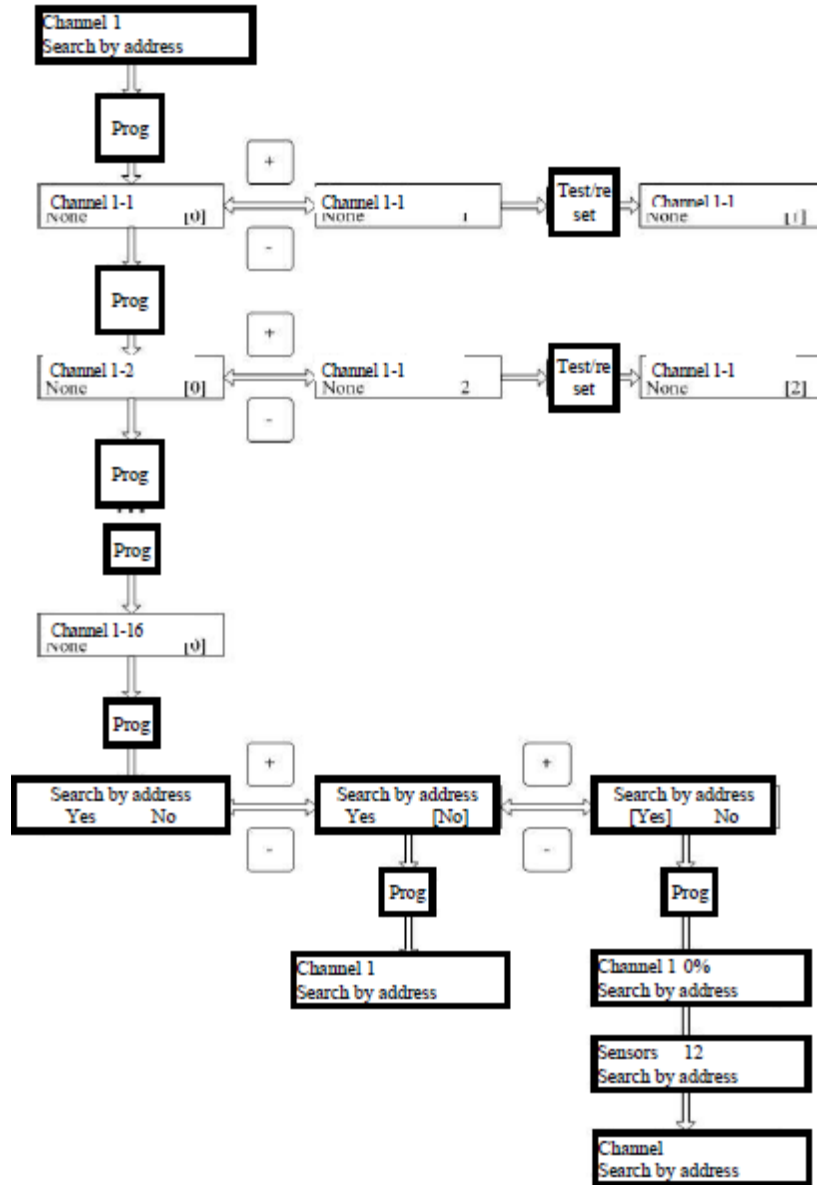

Figure T10

In the sensor address setting menu the top line contains the number of the channel board, in which the search for the sensor will be performed, and the ordinal number of the sensor. If the channel board is set to the operation mode with two independent ports, the numbering of the sensors will be not from 1 to 16 but from 1 up to 8 with indication of the port number to which the sensor is connected, i.e. the top line will look like this ("Channel x-1 P1"), where P1 means that the sensor is connected to the first port.

First in the list there are sensors connected to the first port from 1 to 8, then to the second port from 1 to 8, and the second port will be indicated as be (P2) at the upper right part of the UPES screen. In the lower line the type «None» will be indicated. It means that the type will be determined automatically during the search for the sensor and the sensor MODBUS address that will be identified with the channel board. The sensors with a null address will not participate in the search. It is required to fill in the MODBUS addresses of the sensors, starting from the first sensor. To set the MODBUS address of the sensor press the "+" and "-" buttons.

When setting the MODBUS addresses in this menu, the addresses that have been already input are taken into account, therefore, when selecting the MODBUS addresses with the "+" and "-" buttons, the addresses already input will be ignored. It protects against the input of the repeated addresses to search for the sensors.

When you have entered the desired address, press the (Test/Enter) button to record the address in memory, this address will be in the square brackets. To edit the MODBUS address of the next sensor it is required to press the ("Prog") button. Having entered the required number of addresses, do not change the MODBUS addresses of the remaining sensors, i.e. leave them equal to zero, press the ("Prog") button until you get to the ("Address Search") menu. In this menu to launch the search program press the "+" and "-" buttons to select ("Yes") to launch the search program or ("No") to refuse from searching the sensor and press the ("Prog") button, in this case the channel board will operate with previously detected sensors.

After you select the search program, press the ("Prog") button to start the search program. The channel board will attempt to establish communication with the sensors by the set MODBUS addresses and to determine their type. When the search is complete, the UPES display will display the number of the sensors found. As soon as the channel board finds at least one sensor, the channel board controller goes to the sensors control and parameters measurement state.

Search by Type of Sensors

You can search for known type of sensors by selecting (Channel x Search by type) (fig T8).

Selecting this menu item, can press the ("Prog") button to enter the sensor types setup menu (fig T11).

In the sensor type setting menu the the top line contains the number of the channel board, in which the search for the sensor will be performed, and the ordinal number of the sensor. If the channel board is set to the operation mode with two independent ports, the numbering of the sensors will be not from 1 to 16 but from 1 up to 8 with indication of the port number to which the sensor is connected, i.e. the top line will look like this ("Channel x-1 P1"), where P1 means that the sensor is connected to the first port.

In the operation mode with two independent ports in list first there are sensors connected to the first port from 1 to 8, then to a second port from 1 to 8, the second port would be designated as («P2») at the upper right part of the UPES screen. The bottom line is "None" and it means that the type shall be determined, and the sensor MODBUS address equal to zero means that the address will be detected automatically. The sensors with the «None» type will not participate in the search.

The sensor types shall be to filled in, starting with the first sensor. With the "+" and "-" buttons select the sensor type and press the (Test/Enter) button to record this type in the memory, and then press the ("Prog") key to switch to the next sensor type setting. When you have finished entering the sensor types, do not change the type of the remaining sensors in the menu, leave "None" and press the ("Prog") button until you are in the ("Search by Type"). In this menu if required start the search by type program in the same manner as when searching for the address. The channel board switches to the search by type mode. The central board controller monitors the channel board search process and displays the search progress on the UPES display in the same way when you search for the address.

After finishing the search. the channel board switched to the state and measured parameters control mode for the found sensors. The UPES display will display the number of the sensors found.

Search sensors by the types of sensors specified by the operator:

- SSS —SSS-903, gas analyzer,
- SGO — SGOES-M11, SGOESgas analyzer,
- FRE – IPES fire detector,
- PGU —primary universal transducer,
- SSM– SSS-903ME gas analyzer.
- TGA – TGAES gas analyzer,

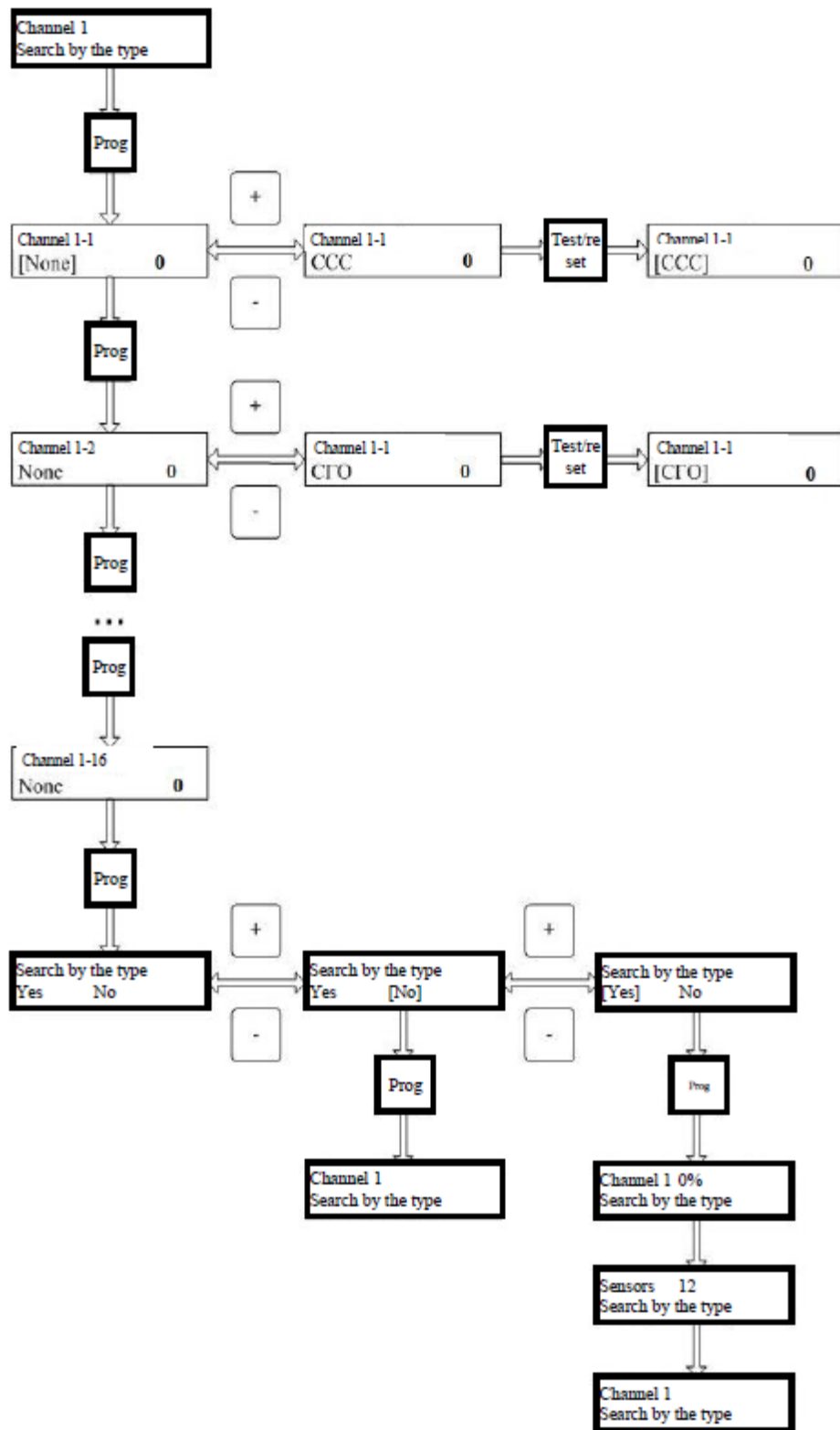

Figure T11

Search by List of Sensors

Search for sensors by the list through the ("Channel x search by list") menu (fig.T8). Before you start the search by the list, you need to set the list of sensor types and addresses. Pressing the ("Prog") button enter the sensor list setup menu. The list of sensors is filled in a manner similar to filling in the list of sensors when you search by the address and type (fig. T12).

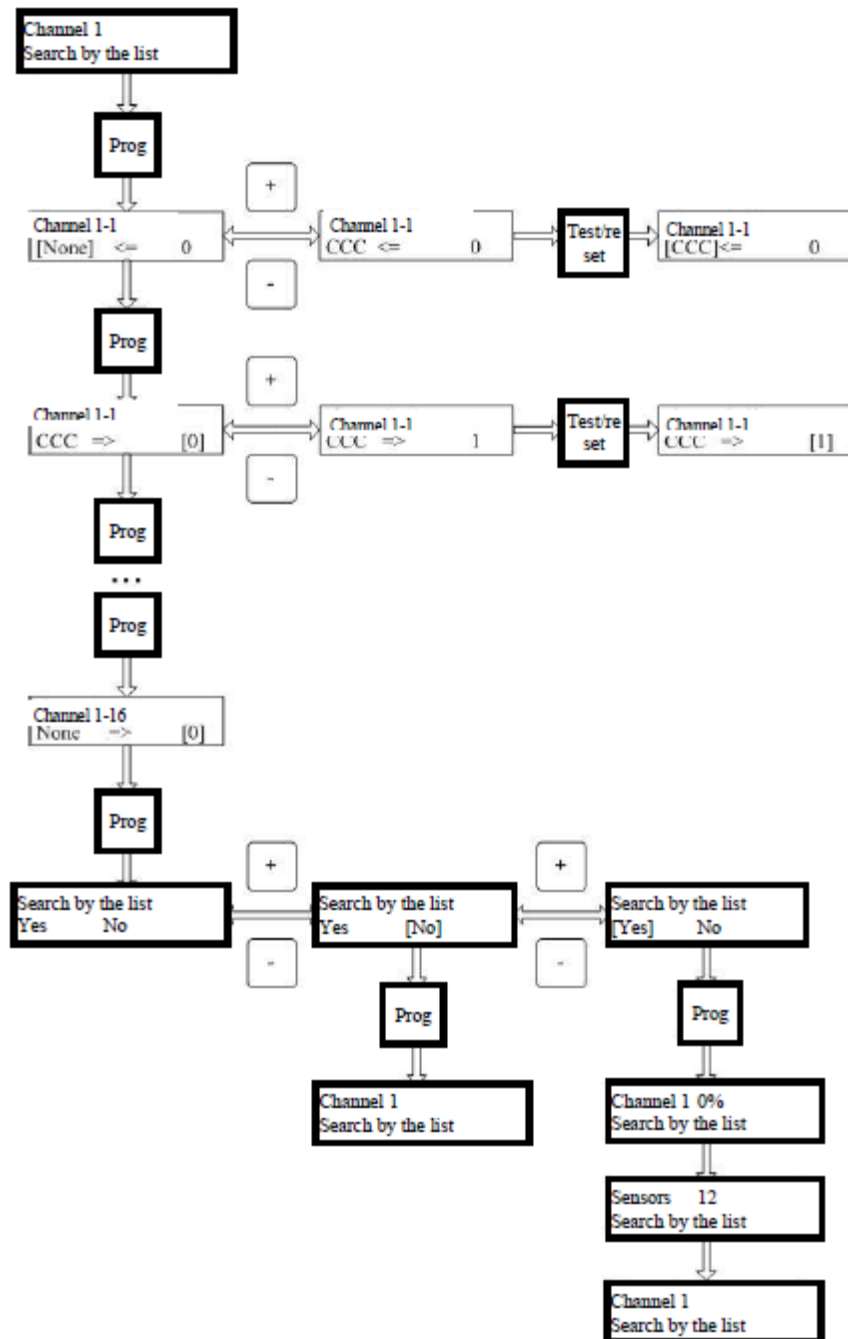

Figure T12

First set the sensor type for the sensor, then press the ("Prog") button and switch to setting the sensor MODBUS address.

The numbering of the sensors is similar to the numbering when searching by address and type from 1 to 8 in the "two port" mode, and with 1 to 16 in all other modes. Setting the necessary number of sensors, press the ("Prog") button until the menu appears.

The search program is started in the same way.

When the search is complete, the display will display the number of sensors found and the two-channel board will switch to the state and measured parameters control mode for the sensor.

If the number and types of sensors found are satisfactory for the user, exit the menu by pressing the ("Control/Exit") button. UPES will switch to standby mode.

Search for Sensors by Searching All Types and Addresses (Automatic Search)

If the user does not know, which sensors are connected to the channel board, the user can choose to search across all types and MODBUS address. To do this, select ("Channel x Search") menu (see figure T8) and press the ("Prog") button and go to the Search program start menu (fig T13).

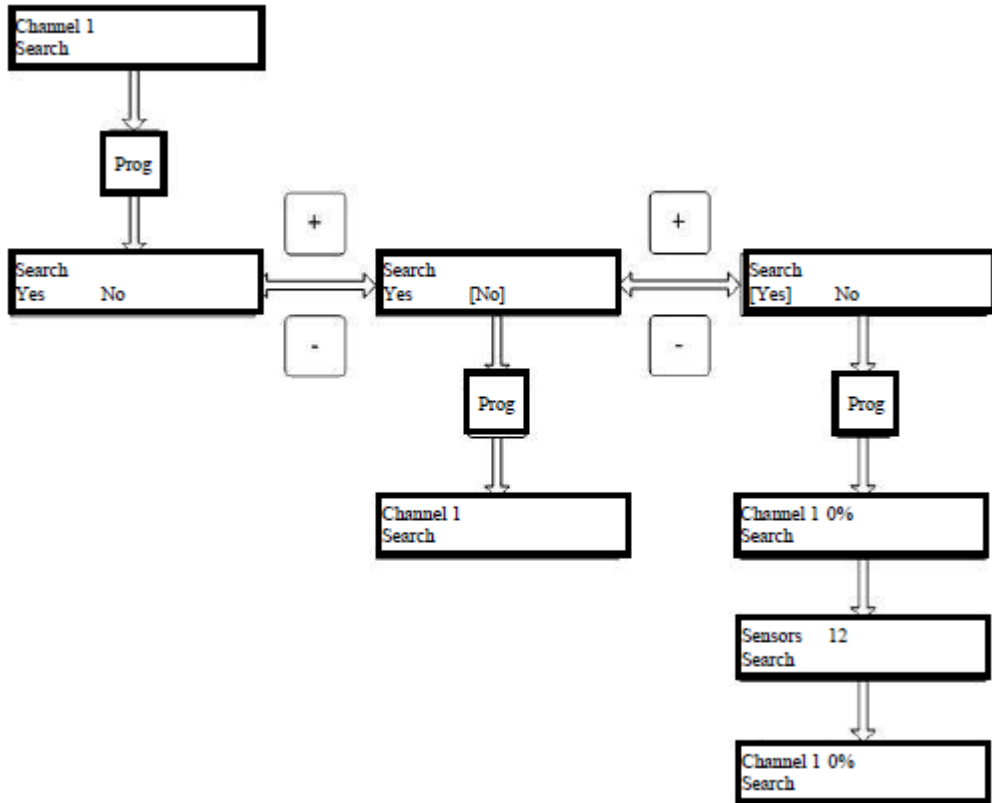

Figure T13

The search program is started in the same way. When the search is complete, the display will display the number of sensors found and the channel board will switch to the state and measured parameters control mode for the sensor.

If the number and types of sensors found are satisfactory for the user, exit the menu by pressing the ("Control/Exit") button. UPES will switch to standby mode.

UPES and PC Exchange Protocol

UPES exchange protocol

Software Version 3.22.04

2 wire RS-485 line.

MODBUS-RTU.

Data read command 3 or 4. Maximum requested number of words for one query does not exceed 32.

Word write command 6.

Checksum — CRC16.

Byte structure:

- 8 information bits;
- no parity;
- 1 stop bit;
- Baud rate: 4800, 9600, 19200, 57600, 115200.

Table 1.

Parameter	Word address, hex	Data type	Details
Modbus address (R/W)	0x0000	BYTE	Lower byte – device Modbus address, 1–247
Device exchange rate (R/W)	0x0001	BYTE	Lower byte – exchange rate with the top level. For the two ports the same rate is set: 2-4800 baud; 3-9600 baud; 4-19200 baud; 5-57600 baud; 6-115200 baud.
Software Version (R)	0x0002 – 0x0003	BYTE	High word: lower byte – version number. Low word: high byte – subversion number 1; lower byte – subversion number 2. Example: 3.21.01 3 – version number; 21 – subversion number 1; 01 – subversion number 2.
Setting 1 card (R/W)	0x0004	BYTE	High byte – communication mode: 0 – 1 port; 1 – 1 port with hot stand-by; 2 – ring; 3 – two independent ports. Lower byte – exchange rate of two ports with sensors: 0 – 1200; 1 – 2400; 2 – 4800; 3 – 9600; 4 – 19200.

Parameter	Word address, hex	Data type	Details
Measurement accuracy of 2 sensor of 1 channel card (R)	0x0103	BYTE	Measurement accuracy.
Concentration of 3 sensor of 1 channel card (R)	0x0104	WORD	Concentration measured by the sensor.
Measurement accuracy of 3 sensor of 1 channel card (R)	0x0105	BYTE	Measurement accuracy.
Concentration of 4 sensor of 1 channel card (R)	0x0106	WORD	Concentration measured by the sensor.
Measurement accuracy of 4 sensor of 1 channel card (R)	0x0107	BYTE	Measurement accuracy.
Concentration of 5 sensor of 1 channel card (R)	0x0108	WORD	Concentration measured by the sensor.
Measurement accuracy of 5 sensor of 1 channel card (R)	0x0109	BYTE	Measurement accuracy.
Concentration of 6 sensor of 1 channel card (R)	0x010A	WORD	Concentration measured by the sensor.
Measurement accuracy of 6 sensor of 1 channel card (R)	0x010B	BYTE	Measurement accuracy.
Concentration of 7 sensor of 1 channel card (R)	0x010C	WORD	Concentration measured by the sensor.
Measurement accuracy of 7 sensor of 1 channel card (R)	0x010D	BYTE	Measurement accuracy.
Concentration of 8 sensor of 1 channel card (R)	0x010E	WORD	Concentration measured by the sensor.
Measurement accuracy of 8 sensor of 1 channel card (R)	0x010F	BYTE	Measurement accuracy.
Concentration of 9 sensor of 1 channel card (R)	0x0110	WORD	Concentration measured by the sensor.
Measurement accuracy of 9 sensor of 1 channel card (R)	0x0111	BYTE	Measurement accuracy.
Concentration of 10 sensor of 1 channel card (R)	0x0112	WORD	Concentration measured by the sensor.

Parameter	Word address, hex	Data type	Details
Measurement accuracy of 10 sensor of 1 channel card (R)	0x0113	BYTE	Measurement accuracy.
Concentration of 11 sensor of 1 channel card (R)	0x0114	WORD	Concentration measured by the sensor.
Measurement accuracy of 11 sensor of 1 channel card (R)	0x0115	BYTE	Measurement accuracy.
Concentration of 12 sensor of 1 channel card (R)	0x0116	WORD	Concentration measured by the sensor.
Measurement accuracy of 12 sensor of 1 channel card (R)	0x0117	BYTE	Measurement accuracy.
Concentration of 13 sensor of 1 channel card (R)	0x0118	WORD	Concentration measured by the sensor.
Measurement accuracy of 13 sensor of 1 channel card (R)	0x0119	BYTE	Measurement accuracy.
Concentration of 14 sensor of 1 channel card (R)	0x011A	WORD	Concentration measured by the sensor.
Measurement accuracy of 14 sensor of 1 channel card (R)	0x011B	BYTE	Measurement accuracy.
Concentration of 15 sensor of 1 channel card (R)	0x011C	WORD	Concentration measured by the sensor.
Measurement accuracy of 15 sensor of 1 channel card (R)	0x011D	BYTE	Measurement accuracy.
Concentration of 16 sensor of 1 channel card (R)	0x011E	WORD	Concentration measured by the sensor.
Measurement accuracy of 16 sensor of 1 channel card (R)	0x011F	BYTE	Measurement accuracy.
Concentration of 1 sensor of 2 channel card (R)	0x0120	WORD	Concentration measured by the sensor.

Parameter	Word address, hex	Data type	Details
Measurement accuracy of 1 sensor of 2 channel card (R)	0x0121	BYTE	Measurement accuracy.
....
Concentration of 16 sensor of 2 channel card (R)	0x013E	WORD	Concentration measured by the sensor.
Measurement accuracy of 16 sensor of 2 channel card (R)	0x013F	BYTE	Measurement accuracy.
...
Flags for 1 threshold triggering of 1-16 sensor of 1 channel card (R)	0x0200	WORD	Triggering flags bit field. 0 bit (lower) – 1 sensor, ... 15 bit – 16 sensor
Flags for 2 threshold triggering of 1-16 sensor of 1 channel card (R)	0x0201	WORD	Triggering flags bit field. 0 bit (lower) – 1 sensor, ... 15 bit – 16 sensor
Defect relay triggering flag of 1-16 sensor of 1 channel card (R)	0x0202	WORD	Triggering flags bit field. 0 bit (lower) – 1 sensor, ... 15 bit – 16 sensor
Relay triggering flag of 1 threshold of 1-16 sensor of 1 channel card (R)	0x0203	WORD	Triggering flags bit field. 0 bit (lower) – 1 sensor, ... 15 bit – 16 sensor
Relay triggering flag of 2 threshold of 1-16 sensor of 1 channel card (R)	0x0204	WORD	Triggering flags bit field. 0 bit (lower) – 1 sensor, ... 15 bit – 16 sensor
Flags of lost communication with sensor 1–16 of 1 channel card (R)	0x0205	WORD	Flags bit field. 0 bit (lower) – 1 sensor, ... 15 bit – 16 sensor
...

Parameter	Word address, hex	Data type	Details
Units of measurement of 1 and 2 sensor of 1 channel card (R)	0x0230	BYTE	High byte – odd sensor units of measurement code, lower byte – of the even sensor. Codes for units of measurement: 0 – LEL; 1 – mg/m ³ ; 2 – vol%; 3 – ppm; 4 – MPC; 5 – ° C; 6 – (no units of measurement); 7 – LEL*m.
Units of measurement of 3 and 4 sensor of 1 channel card (R)	0x0231	BYTE	High byte – odd sensor units of measurement code, lower byte – of the even sensor.
Units of measurement of 5 and 6 sensor of 1 channel card (R)	0x0232	BYTE	High byte – odd sensor units of measurement code, lower byte – of the even sensor.
Units of measurement of 7 and 8 sensor of 1 channel card (R)	0x0233	BYTE	High byte – odd sensor units of measurement code, lower byte – of the even sensor.
Units of measurement of 9 and 10 sensor of 1 channel card (R)	0x0234	BYTE	High byte – odd sensor units of measurement code, lower byte – of the even sensor.
Units of measurement of 11 and 12 sensor of 1 channel card (R)	0x0235	BYTE	High byte – odd sensor units of measurement code, lower byte – of the even sensor.
Units of measurement of 13 and 14 sensor of 1 channel card (R)	0x0236	BYTE	High byte – odd sensor units of measurement code, lower byte – of the even sensor.
Units of measurement of 15 and 16 sensor of 1 channel card (R)	0x0237	BYTE	High byte – odd sensor units of measurement code, lower byte – of the even sensor.
...

Parameter	Word address, hex	Data type	Details
Type of 1-2 sensor of 1 channel card (R)	0x0270	BYTE	High byte – odd sensor type code, lower byte – even sensor type code. Codes for types of sensors: 0 – no sensor; 1 – SSS 903 with electrochemical sensor; 2 – SSS 903 with thermocatalytical sensor; 3 – SSS 903 with optical sensor; 4 – СГОЭС; 5 - SGOES; 6 – IPES IR/UV; 7 – IPES IR3 8 – ПГУ; 9 – SSS-903ME; 10 – TGA receiver; 11 – TGA transmitter;
Type of 3-4 sensor of 1 channel card (R)	0x0271	BYTE	High byte – odd sensor type code, lower byte – even sensor type code.
Type of 5-6 sensor of 1 channel card (R)	0x0272	BYTE	High byte – odd sensor type code, lower byte – even sensor type code.
Type of 7-8 sensor of 1 channel card (R)	0x0273	BYTE	High byte – odd sensor type code, lower byte – even sensor type code.
Type of 9-10 sensor of 1 channel card (R)	0x0274	BYTE	High byte – odd sensor type code, lower byte – even sensor type code.
Type of 11-12 sensor of 1 channel card (R)	0x0275	BYTE	High byte – odd sensor type code, lower byte – even sensor type code.
Type of 13-14 sensor of 1 channel card (R)	0x0276	BYTE	High byte – odd sensor type code, lower byte – even sensor type code.
Type of 15-16 sensor of 1 channel card (R)	0x0277	BYTE	High byte – odd sensor type code, lower byte – even sensor type code.
...
Modbus address of 1 and 2 sensor of 1 channel card (R)	0x02B0	BYTE	High byte – the odd sensor address, lower byte – the even sensor address.
Modbus address of 3 and 4 sensor of 1 channel card (R)	0x02B1	BYTE	High byte – the odd sensor address, lower byte – the even sensor address.
Modbus address of 5 and 6 sensor of 1 channel card (R)	0x02B2	BYTE	High byte – the odd sensor address, lower byte – the even sensor address.

Parameter	Word address, hex	Data type	Details
Modbus address of 7 and 8 sensor of 1 channel card	0x02B3	BYTE	High byte – the odd sensor address, lower byte – the even sensor address.
Modbus address of 9 and 10 sensor of 1 channel card (R)	0x02B4	BYTE	High byte – the odd sensor address, lower byte – the even sensor address.
Modbus address of 11 and 12 sensor of 1 channel card (R)	0x02B5	BYTE	High byte – the odd sensor address, lower byte – the even sensor address.
Modbus address of 13 and 14 sensor of 1 channel card (R)	0x02B6	BYTE	High byte – the odd sensor address, lower byte – the even sensor address.
Modbus address of 15 and 16 sensor of 1 channel card (R)	0x02B7	BYTE	High byte – the odd sensor address, lower byte – the even sensor address.
...
1 threshold of 1 sensor of 1 channel card (R)	0x02F0	WORD	1 threshold = value of this register/10 measurement accuracy (see note 2), in the measurement units of the parameter by the sensor
1 threshold of 2 sensor of 1 channel card (R)	0x02F1	WORD	1 threshold = value of this register/10 measurement accuracy, in the measurement units of the parameter by the sensor
....
1 threshold of 16 sensor of 1 channel card (R)	0x02FF	WORD	1 threshold = value of this register/10 measurement accuracy, in the measurement units of the parameter by the sensor
....
1 threshold of 16 sensor of 8 channel card (R)	0x036F	WORD	1 threshold = value of this register/10 measurement accuracy, in the measurement units of the parameter by the sensor
2 threshold of 1 sensor of 1 channel card (R)	0x0370	WORD	2 threshold = value of this register/10 measurement accuracy, in the measurement units of the parameter by the sensor
2 threshold of 2 sensor of 1 channel card (R)	0x0371	WORD	2 threshold = value of this register/10 measurement accuracy, in the measurement units of the parameter by the sensor
....
2 threshold of 16 sensor of 1 channel card (R)	0x037F	WORD	2 threshold = value of this register/10 measurement accuracy, in the measurement units of the parameter by the sensor

Parameter	Word address, hex	Data type	Details
....
2 threshold of 16 sensor of 8 channel card (R)	0x03EF	WORD	2 threshold = value of this register/10 measurement accuracy, in the measurement units of the parameter by the sensor
....
Gas type of 1-2 sensor of 1 channel card (R)	0x0400	WORD	High byte – odd sensor type code, lower byte – even sensor type code (see Table 10).
Gas type of 3-4 sensor of 1 channel card (R)	0x0401	WORD	High byte – odd sensor type code, lower byte – even sensor type code (see Table 10).
....
Gas type of 7-8 sensor of 8 channel card (R)	0x043F	WORD	High byte – odd sensor type code, lower byte – even sensor type code (see Table 10).

Table 2. Concentration and Accuracy (Register Addresses, hex)

Sensor	Channel Card No.															
	1		2		3		4		5		6		7		8	
	End	Acc.	End	Acc.	End	Acc.	End	Acc.	End	Acc.	End	Acc.	End	Acc.	End	Acc.
1	100	101	120	121	140	141	160	161	180	181	1A0	1A1	1C0	1C1	1E0	1E1
2	102	103	122	123	142	143	162	163	182	183	1A2	1A3	1C2	1C3	1E2	1E3
3	104	105	124	125	144	145	164	165	184	185	1A4	1A5	1C4	1C5	1E4	1E5
4	106	107	126	127	146	147	166	167	186	187	1A6	1A7	1C6	1C7	1E6	1E7
5	108	109	128	129	148	149	168	169	188	189	1A8	1A9	1C8	1C9	1E8	1E9
6	10A	10B	12A	12B	14A	14B	16A	16B	18A	18B	1AA	1AB	1CA	1CB	1EA	1EB
7	10C	10D	12C	12D	14C	14D	16C	16D	18C	18D	1AC	1AD	1CC	1CD	1EC	1ED
8	10E	10F	12E	12F	14E	14F	16E	16F	18E	18F	1AE	1AF	1CE	1CF	1EE	1EF
9	110	111	130	131	150	151	170	171	190	191	1B0	1B1	1D0	1D1	1F0	1F1
10	112	113	132	133	152	153	172	173	192	193	1B2	1B3	1D2	1D3	1F2	1F3
11	114	115	134	135	154	155	174	175	194	195	1B4	1B5	1D4	1D5	1F4	1F5
12	116	117	136	137	156	157	176	177	196	197	1B6	1B7	1D6	1D7	1F6	1F7
13	118	119	138	139	158	159	178	179	198	199	1B8	1B9	1D8	1D9	1F8	1F9
14	11A	11B	13A	13B	15A	15B	17A	17B	19A	19B	1BA	1BB	1DA	1DB	1FA	1FB
15	11C	11D	13C	13D	15C	15D	17C	17D	19C	19D	1BC	1BD	1DC	1DD	1FC	1FD
16	11E	11F	13E	13F	15E	15F	17E	17F	19E	19F	1BE	1BF	1DE	1DF	1FE	1FF

Table 3. Sensor State Flags

Bit Field	Channel Card No.							
	1	2	3	4	5	6	7	8
1 threshold	200	206	20C	212	218	21E	224	22A
2 threshold	201	207	20D	213	219	21F	225	22B
Defect Relay	202	208	20E	214	21A	220	226	22C
1 threshold relay	203	209	20F	215	21B	221	227	22D
2 threshold relay	204	20A	210	216	21C	222	228	22E
Lack of communication relay	205	20B	211	217	21D	223	229	22F

Table 4. Units of Sensor Measurement

Sensor	Channel Card No.							
	1	2	3	4	5	6	7	8
1-2	230	238	240	248	250	258	260	268
3-4	231	239	241	249	251	259	261	269
5-6	232	23A	242	24A	252	25A	262	26A
7-8	233	23B	243	24B	253	25B	263	26B
9-10	234	23C	244	24C	254	25C	264	26C
11-12	235	23D	245	24D	255	25D	265	26D
13-14	236	23E	246	24E	256	25E	266	26E
15-16	237	23F	247	24F	257	25F	267	26F

Table 5. Sensor Types

Sensor	Channel Card No.							
	1	2	3	4	5	6	7	8
1-2	270	278	280	288	290	298	2A0	2A8
3-4	271	279	281	289	291	299	2A1	2A9
5-6	272	27A	282	28A	292	29A	2A2	2AA
7-8	273	27B	283	28B	293	29B	2A3	2AB
9-10	274	27C	284	28C	294	29C	2A4	2AC
11-12	275	27D	285	28D	295	29D	2A5	2AD
13-14	276	27E	286	28E	296	29E	2A6	2AE
15-16	277	27F	287	28F	297	29F	2A7	2AF

Table 6. Sensor Modbus Addresses

Sensor	Channel Card No.							
	1	2	3	4	5	6	7	8
1-2	2B0	2B8	2C0	2C8	2D0	2D8	2E0	2E8
3-4	2B1	2B9	2C1	2C9	2D1	2D9	2E1	2E9
5-6	2B2	2BA	2C2	2CA	2D2	2DA	2E2	2EA
7-8	2B3	2BB	2C3	2CB	2D3	2DB	2E3	2EB
9-10	2B4	2BC	2C4	2CC	2D4	2DC	2E4	2EC
11-12	2B5	2BD	2C5	2CD	2D5	2DD	2E5	2ED
13-14	2B6	2BE	2C6	2CE	2D6	2DE	2E6	2EE
15-16	2B7	2BF	2C7	2CF	2D7	2DF	2E7	2EF

Table 7. Sensor Thresholds. 1 threshold

Sensor	Channel Card No.							
	1	2	3	4	5	6	7	8
1	2F0	300	310	320	330	340	350	360
2	2F1	301	311	321	331	341	351	361
3	2F2	302	312	322	332	342	352	362
4	2F3	303	313	323	333	343	353	363
5	2F4	304	314	324	334	344	354	364
6	2F5	305	315	325	335	345	355	365
7	2F6	306	316	326	336	346	356	366
8	2F7	307	317	327	337	347	357	367
9	2F8	308	318	328	338	348	358	368
10	2F9	309	319	329	339	349	359	369
11	2FA	30A	31A	32A	33A	34A	35A	36A
12	2FB	30B	31B	32B	33B	34B	35B	36B
13	2FC	30C	31C	32C	33C	34C	35C	36C
14	2FD	30D	31D	32D	33D	34D	35D	36D
15	2FE	30E	31E	32E	33E	34E	35E	36E
16	2FF	30F	31F	32F	33F	34F	35F	36F

Table 8. 2 threshold

Sensor	Channel Card No.							
	1	2	3	4	5	6	7	8
1	370	380	390	3A0	3B0	3C0	3D0	3E0
2	371	381	391	3A1	3B1	3C1	3D1	3E1
3	372	382	392	3A2	3B2	3C2	3D2	3E2
4	373	383	393	3A3	3B3	3C3	3D3	3E3
5	374	384	394	3A4	3B4	3C4	3D4	3E4
6	375	385	395	3A5	3B5	3C5	3D5	3E5
7	376	386	396	3A6	3B6	3C6	3D6	3E6
8	377	387	397	3A7	3B7	3C7	3D7	3E7
9	378	388	398	3A8	3B8	3C8	3D8	3E8
10	379	389	399	3A9	3B9	3C9	3D9	3E9
11	37A	38A	39A	3AA	3BA	3CA	3DA	3EA
12	37B	38B	39B	3AB	3BB	3CB	3DB	3EB
13	37C	38C	39C	3AC	3BC	3CC	3DC	3EC
14	37D	38D	39D	3AD	3BD	3CD	3DD	3ED
15	37E	38E	39E	3AE	3BE	3CE	3DE	3EE
16	37F	38F	39F	3AF	3BF	3CF	3DF	3EF

Table 9. Gases Analyzed by Sensors.

Sensor	Channel Card No.							
	1	2	3	4	5	6	7	8
1-2	400	408	410	418	420	428	430	438
3-4	401	409	411	419	421	429	431	439
5-6	402	40A	412	41A	422	42A	432	43A
7-8	403	40B	413	41B	423	42B	433	43B
9-10	404	40C	414	41C	424	42C	434	43C
11-12	405	40D	415	41D	425	42D	435	43D
13-14	406	40E	416	41E	426	42E	436	43E
15-16	407	40F	417	41F	427	42F	437	43F

Table 10. Gas Designation (codes 19 and 69 do not refer to gas analyzers, see note 1).

No.	Designation	Gas
0	NON	no gas
1	CH4	methane
2	PRO	propane
3	BUT	butane
4	ISB	Isobutane C4H10
5	PNT	Pentane
6	CLP	Cyclopentane
7	HEX	Hexane
8	ETO	Ethanol
9	ACE	Acetylene
10	H2	Hydrogen
11	O2	Oxygen
12	CO	Carbon oxide
13	CO2	Carbon dioxide
14	H2S	Hydrogen sulfide
15	NO2	Nitrogen dioxide
16	SO2	Sulphur dioxide
17	NH3	Ammonia
18	CL2	Chlorine
19	FRE	fire detector (ИПЭС or ИПЦЭС)
20	MTH	methanol
21	ETH	ethylene
22	BEN	benzene

23	ETN	Ethan
24	ACT	acetone
25	TOL	toluol
26	MTB	MTBE
27	OIL	oil
28	GAS	natural gas
29	GSL	gasoline
30	KER	kerosene
31	WSP	White spirit
32	DOI	diesel
33	PCH	petroleum product
34	FMD	formaldehyde
35	VAT	vinyl acetate
36	HEP	heptane
37	ORX	o-xylene
38	PRX	p-xylene
39	ISO	isopropanol
40	CLX	cyclohexane
41	ETZ	ethylbenzene
42	PRL	propylene
43	BUD	butadiene
44	STN	Styrene
45	CLM	Chloromethane
46	DCM	Dichloromethane
47	BTA	Butyl acetate
48	ETA	Ethyl acetate
49	BTN	Butanone
50	CHN	Cyclohexanone
51	PRL	Propanol
52	BTL	Butanol
53	OCT	Octane
54	ETO	Ethylene oxide
55	DTM	Diethylamine
56	IBN	Isobutylene
57	HCL	hydrogen chloride
58	HF	hydrogen fluoride
59	not used	Not used
60	MMP	methyl mercaptan
61	EMP	ethyl mercaptan
62	NAC	nitric acid
63	NO	nitrogen oxide
64	HDZ	hydrazine
65	PHN	phenol
66	CS2	carbon disulfide
67	AKN	Acrylonitrile
68	TFE	tetrafluoroethylene
69	TGA	TGA transmitter

Note 1

The measured concentration value is encoded as the content of the two registers. The measured concentration value = concentration / 10^{measurement accuracy} (measurement accuracy is the measure of the degree with the base 10, which corresponds to the number of digits after the decimal comma in the measured concentration value). Threshold values are encoded in the same way using the same accuracy register.

Power Cable Connection Diagram

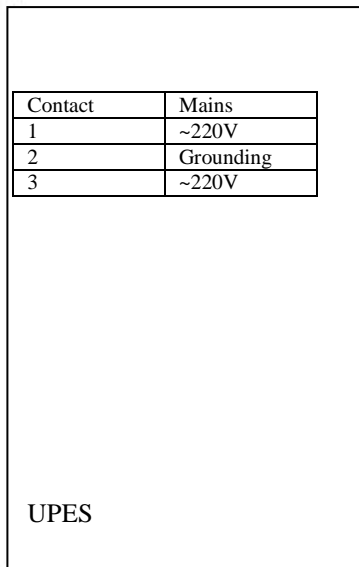

Connector P587

Mains	Contact
~220V	1
Grounding	2
~220V	3

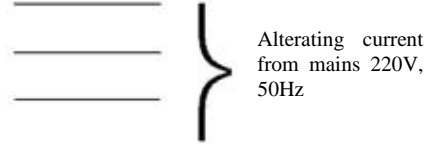

Wiring Diagrams for Flame Detectors

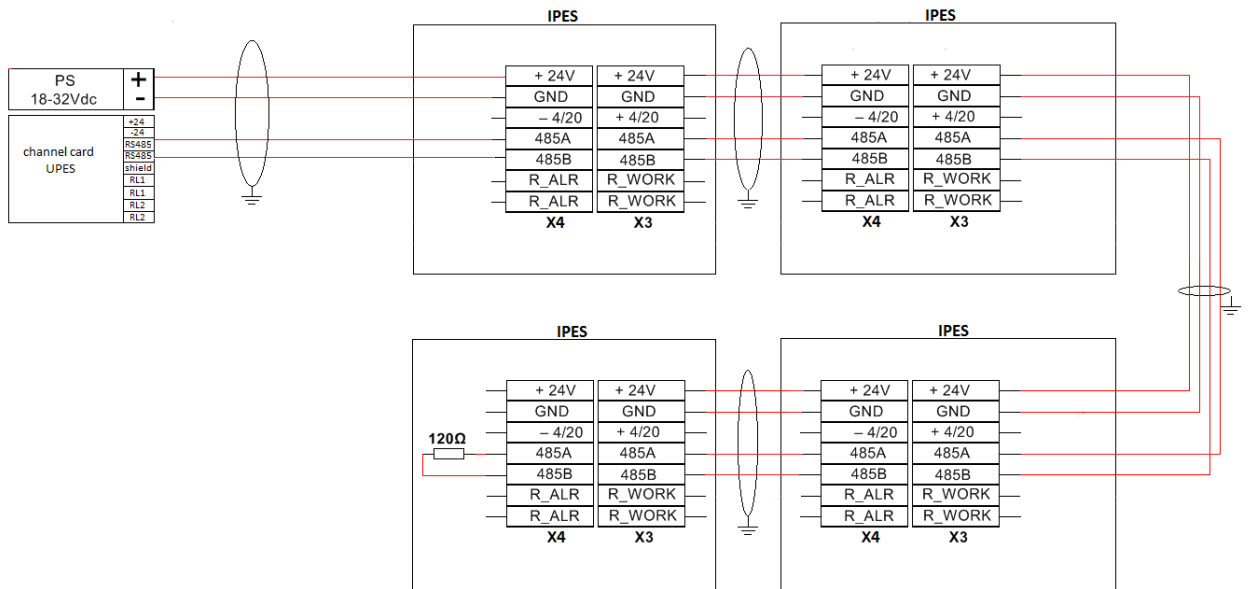

Wiring Diagrams for Gas Detectors

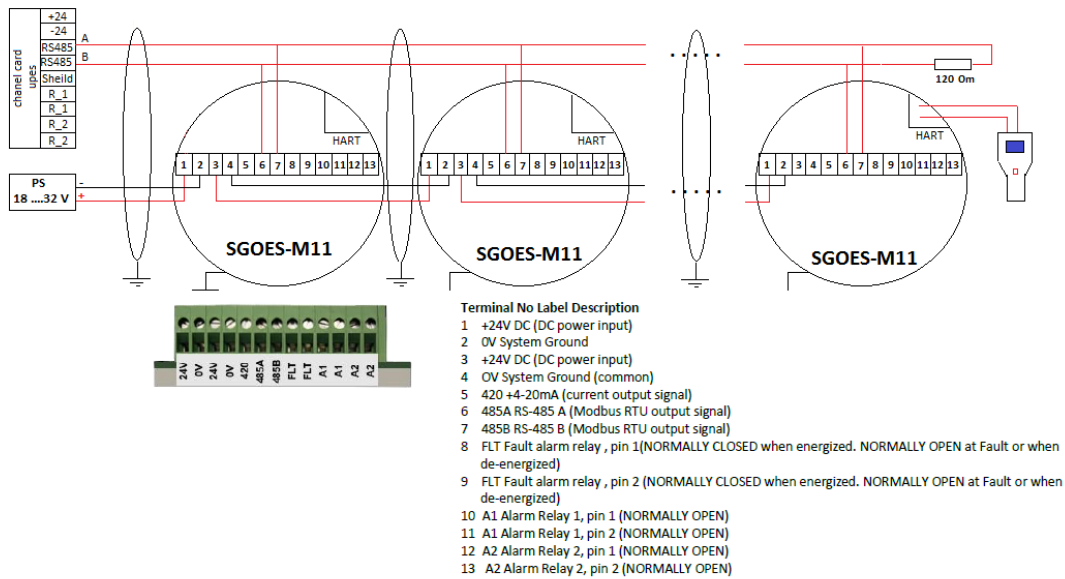
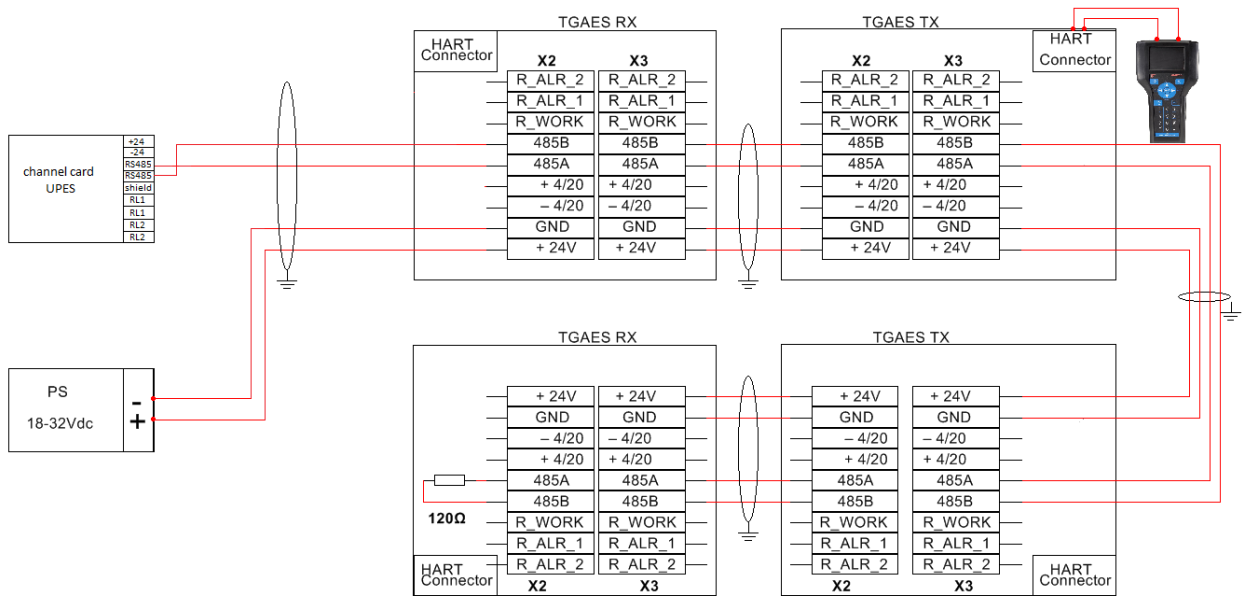

UPES Markings

The UPES device has the following marking:

- manufacturing plant trademark;
- UPES conventional designation;
- serial number;
- year of manufacture.

Transportation and Storage

UPES, packed by the manufacturer, can be transported at any distance by any means of transport. When transporting, it is necessary to ensure weather protection of the transport container with packed devices. Placement and securing of cargo in transport facilities shall ensure its stable position during transportation. Shifting of cargo during transportation is not permitted.

Rail wagons, containers and car bodies used to transport the device shall be free of any signs of cement, coal, chemicals etc.

UPES, packed by the manufacturer, during their guaranteed storage life shall be stored in premises free of dust, alkali/acid fumes, aggressive gases and other harmful impurities.

Maintenance

UPES is intended for long-term continuous operation and requires special routine works to be implemented during operation.

In case of any doubt in UPES operation validity, it is recommended to check the validity of channel programming. Channel programming shall be performed in accordance with the cyclogram specified in this manual. Programming of other UPES parameters shall be also performed in accordance with the cyclogram specified in this OM.

Preventive Maintenance during UPES Operation

Preventive maintenance is the procedure and frequency of works on maintenance and restoration of UPES efficiency during its operation.

All types of performed works are classified into three subgroups:

- 1) maintenance;
- 2) technical repair;
- 3) major overhaul.

Maintenance. Maintenance includes:

- maintenance check;
- preventive inspection.

Maintenance check is performed by an EC&I engineer (or a person that replaces him/her) in order to timely detect and eliminate any malfunctions during operation.

The maintenance scope covers the following works:

- Visual inspection of equipment.
- Dust and dirt elimination.
- Switching on test mode in order to check operability.
- Minor troubleshooting.
- Check of grounding.
- Check of supply mains voltage.
- Check of protection.
- Check of harness and terminal connections state.

Technical repair. The scope of technical repair includes all maintenance operations plus the following works:

- Opening of the threshold device.

- Washing and cleaning of mechanical parts and contact connections.
- Elimination of detected defects.
- Cleaning of connectors.
- Insulation withstand-voltage test.
- Measurement of insulation resistance.

Major overhaul. The major overhaul includes all technical repair operations plus the following works:

Replacement of individual channel modules and other assemblies by specialists authorized for such works.

Maintenance and Repair Frequency

Maintenance and repair shall be with the following frequency:

- maintenance check – every day;
- maintenance – once per quarter;
- technical repair – once per year;
- major overhaul – once per 5 years.

Warranties:

ESP Safety Inc, 555 N. First Street San Jose, CA 95112 USA, guarantees the UPES system will be free of manufacturing defects for 5 years after date of commissioning, provided the customer follows all guidelines pertaining to installation, operation, and maintenance detailed in this Operating Manual.

Unit Warranty

During this warranty period, the manufacturer will correct any failures detected in the UPES system or replace any damaged unit free of charge.

Expected Service Life of Unit

The average expected life of the UPES system is no less than 10 years