

**The D2xC1 Alarm Horn and Strobe is CE marked for compliance with the European Explosive Atmospheres Directive 94/9/EC and the European EMC Directive 89/336/EEC**

### 1) Introduction

The D2xC1 is an ATEX, IECEx and UL certified Alarm Horn and Strobe which produces a loud warning signal and bright visual signal in a hazardous area. Sixty-Four first stage alarm sounds can be selected by internal switches and each one can be externally changed to a second, third or fourth stage alarm sound. The unit may be used for Gas applications in Zone 2 / Class I Zone 2 / Class I, Division 2 as well as for Dust applications in Zone 22 / Class II Zone 22 / Class II Division 2 / Class III Division 1 & 2. The beacon flashes at a set rate of 1Hz.

### 2) Warnings

SUITABLE FOR USE IN CLASS II, DIVISION 2, GROUPS A, B, C AND D HAZARDOUS LOCATIONS  
 SUITABLE FOR USE IN CLASS II, DIVISION 2, GROUPS E, F AND G HAZARDOUS LOCATIONS  
 WARNING: DO NOT OPEN WHEN EXPLOSIVE ATMOSPHERE IS PRESENT  
 WARNING – EXPLOSION HAZARD – SUBSTITUTION OF ANY COMPONENT MAY IMPAIR SUITABILITY FOR CLASS I, DIVISION 2.  
 WARNING – EXPLOSION HAZARD – SUBSTITUTION OF ANY COMPONENTS MAY IMPAIR SUITABILITY FOR CLASS II, DIVISION 2.  
 POTENTIAL ELECTROSTATIC CHARGING HAZARD – CLEAN ONLY WITH A DAMP CLOTH  
 USE HEAT RESISTANT CABLES AND CABLE GLANDS (RATED 90°C OR HIGHER)  
 EXPLOSION HAZARD. DO NOT REMOVE OR REPLACE LAMPS, FUSES OR PLUG-IN MODULES UNLESS POWER HAS BEEN DISCONNECTED OR THE AREA IS KNOWN TO BE FREE OF IGNITIBLE CONCENTRATIONS OF FLAMMABLE GASES OR VAPORS.  
 EXPLOSION HAZARD. DO NOT DISCONNECT WHILE THE CIRCUIT IS LIVE OR UNLESS THE AREA IS KNOWN TO BE FREE OF IGNITIBLE CONCENTRATIONS.

### 3) Ratings and Markings

#### 3.1 ATEX / IECEx certification

The D2xC1 Alarm Horn and Strobe complies with the following standards:

EN60079-0:2012+A11:2013 / IEC60079-0: ed. 6.0 (2011-06)  
 EN60079-15:2010 / IEC60079-15: ed. 4.0 (2010-01)  
 EN60079-31:2009 / IEC60079-31: ed. 1.0 (corr. 1 2009)

The EC-Type Examination Certificate DEMKO 14ATEX4786493904X / IECEx ULD14.0004X has been issued by UL. This confirms compliance with the European ATEX Directive 94/9/EC for Group II, Category 3G/D equipment. The unit carries the Community Mark and subject to local codes of practice, may be installed in any of the EEA member countries. This instruction sheet describes installations which conform to the current issue of EN60079-14/IEC60079-14 Electrical Installation in Hazardous Areas; EN60079-10-1 / IEC 60079-10-1 Explosive Atmospheres - Classification of Areas. Explosive Gas Atmospheres; EN60079-10-2 / IEC 60079-10-2 Explosive Atmospheres - Classification of Areas. Explosive Dust Atmospheres. When designing systems for installation outside the UK, the local Code of Practice should be consulted.

The D2XC1X05 is rated as follows:

 II 3G Ex nA IIC T2 Gc (Ta -40°C to +50°C)  
 II 3D Ex tc IIIC T90°C Dc (Ta -40°C to +50°C)

The D2XC1X10 is rated as follows:

 II 3G Ex nA IIC T1 Gc (Ta -40°C to +50°C)  
 II 3G Ex nA IIC T2 Gc (Ta -40°C to +40°C)  
 II 3D Ex tc IIIC T110°C Dc (Ta -40°C to +50°C)

CE marking:



#### Zones, Gas / Dust Groups and Temperature Classification

When connected to an approved system the D2X unit may be installed in:

- Zone 2 explosive gas air mixture not likely to occur in normal operation, and if it does, it will only exist for a short time.
- Zone 22 explosive dust air mixture not likely to occur in normal operation, and if it does, it will only exist for a short time.

#### May be used with gases in groups:

- Group IIA propane
- Group IIB ethylene
- Group IIC hydrogen / acetylene

#### Having a temperature classification (for Gas applications) of:

- T1 450°C
- T2 300°C

### May be used with Dust types:

Group IIIA combustible flyings  
Group IIIB non-conductive dust  
Group IIIC conductive dust

### Maximum Surface Temperature for Dust Applications:

For D2xC1X05: 90°C

For D2xC1X10: 110°C

### 3.2 Class / Zone ratings for US

The D2xC1 Alarm Horn and Strobe complies with the following standards:

ANSI/UL 60079-0-2013  
ANSI/UL60079-15-2013  
ISA60079-31-2013

The D2XC1X05 Alarm Horn and Strobe is rated as follows:

Class I, Zone 2 AEx nA IIC T2 Gc (Ta -40°C to +50°C)  
Zone 22 AEx tc IIIC T120°C Dc (Ta -40°C to +50°C)

The D2XC1X10 Alarm Horn and Strobe is rated as follows:

Class I, Zone 2 AEx nA IIC T1 Gc (Ta -40°C to +50°C)  
Class I, Zone 2 AEx nA IIC T2 Gc (Ta -40°C to +40°C)  
Zone 22 AEx tc IIIC T120°C Dc (Ta -40°C to +50°C)

Installation must be carried out in compliance with the National Electric Code

### 3.3 Class / Zone ratings for Canada

The D2xC1 Alarm Horn and Strobe complies with the following standards:

CAN/CSA C22.2 No. 60079-0:11  
CAN/CSA C22.2 No. 60079-15:12  
CAN/CSA C22.2 No. 60079-31:12

The D2XC1X05 Alarm Horn and Strobe is rated as follows:

Ex nA IIC T2B Gc X (Ta -40°C to +50°C)  
Ex nA IIC T2C Gc X (Ta -40°C to +45°C)  
Ex tc IIIC T120°C Dc (Ta -40°C to +50°C)  
Class II, Div 2 EFG T4A (Ta -40°C to +50°C)

The D2XC1X10 Alarm Horn and Strobe is rated as follows:

Ex nA IIC T1 Gc X (Ta -40°C to +50°C)  
Ex nA IIC T2 Gc X (Ta -40°C to +40°C)  
Ex tc IIIC T120°C Dc (Ta -40°C to +50°C)  
Class II, Div 2 EFG T4A (Ta -40°C to +50°C)

Installation must be carried out in compliance with the Canadian Electric Code

### 3.4 Class / Division Ratings for US and Canada

D2xC1 Alarm Horn and Strobe complies with the following standards:

ANSI/ISA 12.12.01-2013  
CSA C22.2 No. 213-M1987  
CSA C22.2 No. 157-92:2006

#### For D2xC1X05:

Class I Div 2 ABCD T2B Ta -40°C to +70°C  
Class I Div 2 ABCD T2C Ta -40°C to +55°C

Class I Div 2 ABCD T2D Ta -40°C to +40°C  
Class II Div 2 FG T5 Ta -40°C to +50°C  
Class III Div 1&2 Ta -40°C to +50°C

#### For D2xC1X10:

Class I Div 2 ABCD T1 Ta -40°C to +70°C  
Class I Div 2 ABCD T2 Ta -40°C to +50°C  
Class II Div 2 FG T4A Ta -40°C to +50°C  
Class II Div 2 FG T5 Ta -40°C to +40°C  
Class III Div 1&2 Ta -40°C to +50°C

Installation must be carried out in compliance with the National Electric Code / Canadian Electric Code

### 3.5 Ambient Temperature Range:

-40°C to +70°C (Class I Div 2 only)  
-40°C to +50°C

### 3.5 Ingress Protection Ratings

The product is rated for ingress Protection as follows:

IP rating per EN60529: IP66  
Type rating per UL50E / NEMA250: 4 / 4X / 3R / 13

To maintain the ingress protection rating, the two off M20 cable entries must be fitted with suitably rated, certified cable entry and/or blanking devices during installation.

### 3.6 Electrical Ratings

Part No.	Nominal Voltage	Nominal Current	Voltage Range	Max Current
D2xC1X05 DC024	24Vdc	513mA	20-28Vdc	521mA @ 20Vdc
D2xC1x05 DC048	48Vdc	311mA	42-58Vdc	328mA @ 42Vdc
D2xC1x05 AC115	115Vac	174mA	115-125Vac 60Hz	183mA @ 125Vac
D2xC1x05 AC230	230Vac	63mA	215-250Vac 50Hz	77mA @ 250Vac
D2xC1X10 DC024	24Vdc	876mA	20-28Vdc	876mA @ 20Vdc
D2xC1x10 DC048	48Vdc	461mA	42-58Vdc	475mA @ 42Vdc
D2xC1x10 AC115	115Vac	320mA	115-125Vac 50Hz	343mA @ 125Vdc
D2xC1x10 AC230	230Vac	100mA	215-250Vac 60Hz	115mA @ 250Vdc

A supply voltage variation of +/-10% is permissible.

### 4) Special Conditions for Safe Use

Special Condition for safe Use as stated on the Type Examination Certificate DEMKO 14 ATEX 4786493904X / CoC IECEx ULD 14.0004X:

End user shall adhere to the manufacturer's installation and instruction when performing housekeeping to avoid the potential for hazardous electrostatic charger during cleaning, by using a damp cloth.

The D2xC1 is not to be mounted with the horn facing upwards  
The equipment shall only be used in end use with appropriately certified cable entry devices and blanking plugs

## 4.1 Installation

The product must only be installed by suitably qualified personnel in accordance with the latest issues of the relevant standards.

The installation of the units must also be in accordance with any local codes that may apply and should only be carried out by a competent electrical engineer who has the necessary training.

The equipment is not to be mounted with the horn facing upwards.

The equipment has not been assessed as a safety-related device (as referred to by Directive 94/9/EC Annex II, clause 1.5).

The cable entry temperature may exceed +70°C / the cable branching point may exceed 80°C. Therefore suitable heat resisting cables and cable glands must be used, with a rated service temperature of at least 90°C

To maintain the ingress protection rating and mode of protection, the M20 x 1.5 cable entries must be fitted with suitably rated, certified cable glands and/or suitably rated, certified blanking devices during installation. If a high IP (Ingress Protection) rating is required then a suitable sealing washer must be fitted under the cable gland. For use in explosive gas atmospheres a minimum ingress protection rating of IP54 must be maintained. For use in explosive dust atmospheres a minimum ingress protection rating of IP64 must be maintained.

Only the front cover is to be used for access to the enclosure for installation, service and maintenance. Once the product is opened, the Type Rating cannot be maintained anymore unless a full verification of the gasket material is done and there is no damage.

Connections are to be made into the terminal blocks using solid or stranded wire, sizes 0.5-2.5mm<sup>2</sup> / AWG 20-14. Wire insulation needs to be stripped 6-7mm. Wires may be fitted securely with crimped ferrules. Terminal screws need to be tightened down with a tightening torque of 0.56 Nm / 5 Lb-in.

Internal earthing connections should be made to the internal earth terminal on the PCBA. The earth conductor should be at least equal in size and rating to the incoming power conductors. The internal earth bonding wire connects the PCBA earth terminal to the internal earth terminal in the enclosure back box.

External earthing connections should be made to the M5 earth stud, using a ring crimp terminal to secure the earth conductor to the earth stud. The external earth conductor should be at least 4mm<sup>2</sup> / AWG 11 in size.

Check that the earth bonding wire between the two castings is secure and the 'O' ring seal is in place and in good condition.

## 4.2 Maintenance, Overhaul and Repair

Maintenance, repair and overhaul of the equipment should only be carried out by suitably qualified personnel in accordance with the current relevant standards:

EN60079-19 / IEC60079-19 Explosive atmospheres - Equipment repair, overhaul and reclamation  
EN 60079-17/ IEC60079-17 Explosive atmospheres - Electrical installations inspection and maintenance

Units must not be opened while an explosive atmosphere is present.

If opening the unit during maintenance operations a clean environment must be maintained and any dust layer removed prior to opening the unit.

Electrostatic charging hazard - Clean only with a damp cloth

## 5) Installation

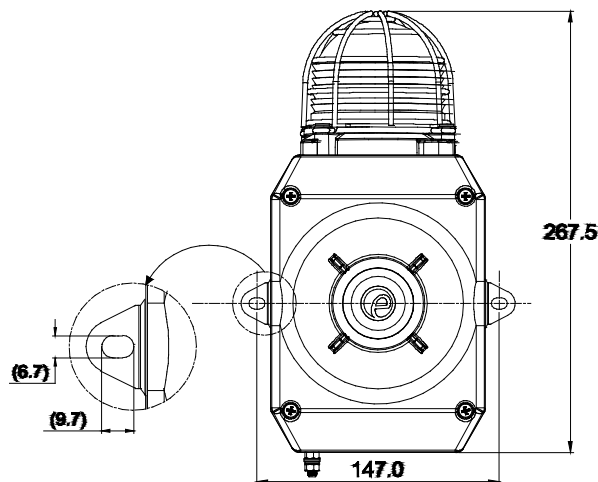

Fig. 1 Fixing locations.

D2x1 Alarm Horn and Strobe should only be installed by trained competent personnel.

### 5.1 Mounting

The D2x1 Alarm Horn and Strobe may be secured to any flat surface using the two 9.7 x 6.7mm, 147mm pitch fixing holes. The enclosure provides IP66 protection and is suitable for installation in exterior locations providing it is positioned so that water cannot collect in the horn, and the cable entry is sealed.

### 5.2 Installation procedure

- Secure the D2x1 Alarm Horn and Strobe to a flat surface via the two 9.7 x 6.7mm, 147mm pitch fixing holes in the mounting feet.
- Remove the front of the unit by unscrewing the four captive cover screws and pulling the front away from the enclosure.
- Fit an M20x1.5 suitably rated, certified cable gland or conduit entry into the hole in the enclosure and connect the field wiring to the appropriate alarm horn terminals as shown in section 9 and fig 8 (DC) or section 8 fig 5 (AC) of this manual. The power supply terminals are duplicated so that horns may be connected in parallel and for DC units only an end of line monitoring resistor may be fitted. If the second M20x1.5 entry is not used a suitably rated, certified stopping plug must always be fitted.
- Select the required output tone by positioning the six switches as shown in Table 1 and Fig 2.
- Adjust the internal volume control to provide the required sound level.
- Check that the O-ring seal in the front cover is in good condition and not damaged.
- Replace the front of the unit and tighten the four captive cover screws.

## 6) Volume Control

The alarm horn output level of the D2x1 unit can be set by adjusting the volume control potentiometer (see Fig 2). For maximum output, set the potentiometer fully clockwise.

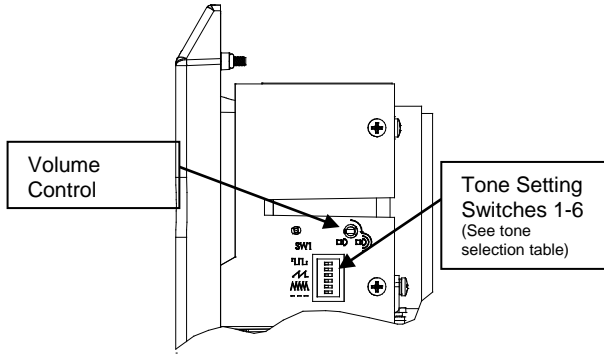

Fig. 2 Location of field controls

## 8.2 Unit's First Stage Tones

Stage one (S1) operation: Simply connect the supply voltage to the L and N supply terminals, (see fig. 5). The Strobe is powered via factory installed wires connected to the sounder. The wires connecting the alarm horn and strobe can be removed if the user wishes to power the strobe separately.

## 8.3 Second, Third and Fourth Stage Tone Selection

To select the second, third and fourth stage tones on the D2xS1 AC alarm horns.

Stage two (S2) operation: Power L and N, link the common (C) and S2 terminal.

Stage three (S3) operation: Power L and N, link the common (C) and S3 terminals.

Stage four (S4) operation: Power L and N, link the common (C) and both the S2 and S3 terminals.

Strobe will continue to flash during alarm horn S2, S3 & S4 stages.

## 7) Cable Routing and Tone Selection

### 7.1 Cable Routing

Due to the compact design of the D2x units, it is important that the user strips the outer sheath of and biases any cables over the size of 1mm<sup>2</sup> as shown below.

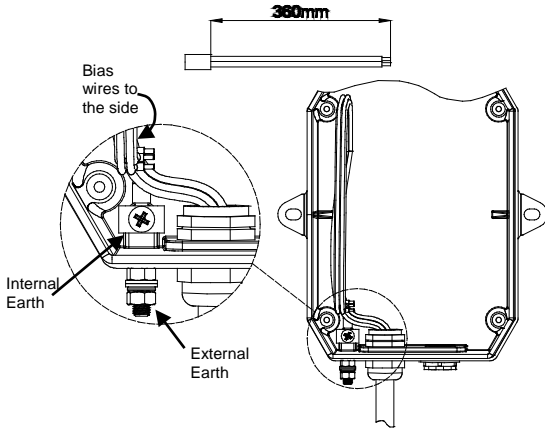

\*Glands and/or stopping plugs to be customer supplied to suit application.

Fig 3. Cables are to be stripped and biased toward side of unit with allocated spacing as shown.

### 7.2 Tone Selection

The D2xS1 alarm horns have 64 different tones. The tones are selected by operation of the tone setting DIP switches (see Fig. 2) on the PCB. The alarm horns can also be switched to sound the second, third and fourth stage alarm tones. The tone table (Table 1) shows the switch positions for the 64 tone and which tones are available for the second, third and fourth stages.

## 8) AC Wiring

### 8.1 Wiring Diagram

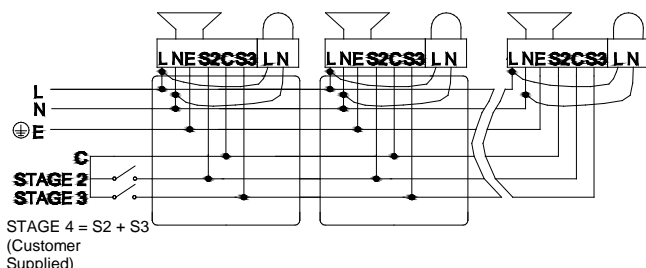

Fig 4. AC Simplified Block Diagram

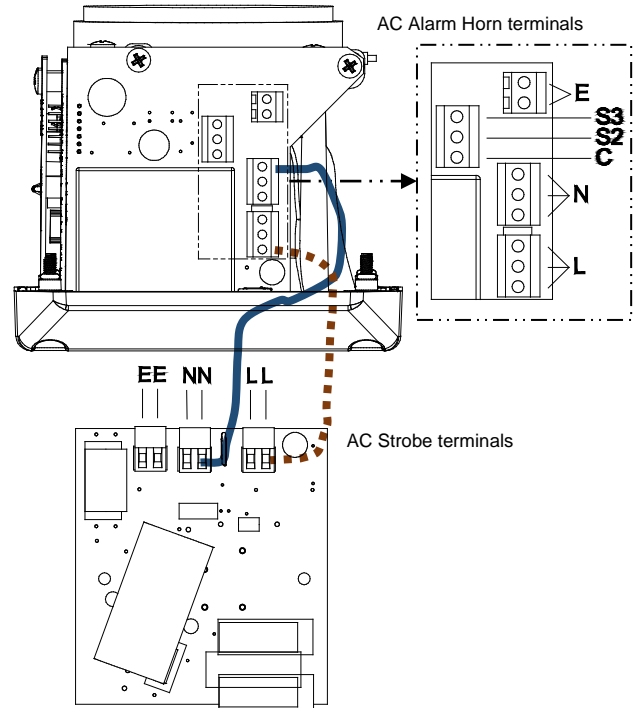

Fig. 5 AC Terminals

## 9) DC Wiring

### 9.1 DC Stage Polarity Control

The stage switches of the DC powered D2x units can be activated via Positive (+ve) or Negative (-ve) switching. All units are factory set to -ve switching as standard. If +ve switching is required, the two wire links should be removed from the '-' positions of the stage polarity control terminals and fitted to the '+' positions as shown in fig 6.

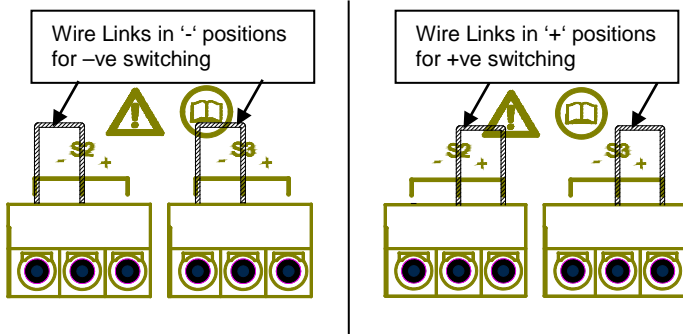

Fig. 6 Stage Polarity Control settings.

## 9.2 Wiring Diagrams

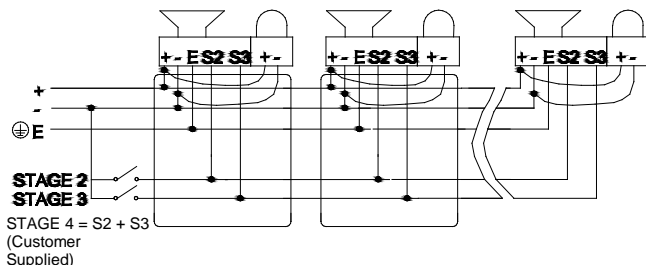

Fig. 7a DC Simplified Block Diagram (negative switching). Optional arrangement.

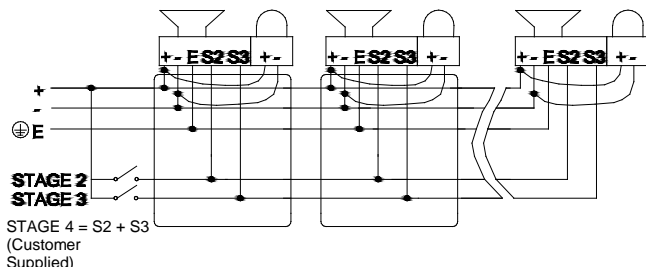

Fig. 7b DC Simplified Block Diagram (positive switching). Optional arrangement.

## 9.3 Units First Stage Tones

Stage one (S1) operation: Simply connect the supply voltage to the + and - supply terminals, (see fig. 8). The Strobe is powered via factory installed wires connected to the alarm horn. The wires connecting the alarm horn and strobe can be removed if the user wishes to power the strobe separately.

## 9.4 Second, Third and Fourth Stage Tone Selection

**For units set up for -ve switching (default setting):**

Stage two (S2) operation: Power +ve and -ve, link a -ve supply line to the S2 terminal.

Stage three (S3) operation: Power +ve and -ve, link a -ve supply line to the S3 terminal.

Stage four (S4) operation: Power +ve and -ve, link a -ve supply line to both the S2 & S3 terminals.

Strobe will continue to flash during alarm horn S2, S3 & S4 stages.

**For units set up for +ve switching (refer to 9.1):**

Stage two (S2) operation: Power +ve and -ve, link a +ve supply line to the S2 terminal.

Stage three (S3) operation: Power +ve and -ve, link a +ve supply line to the S3 terminal.

Stage four (S4) operation: Power +ve and -ve, link a +ve supply line to both the S2 & S3 terminals.

Strobe will continue to flash during alarm horn S2, S3 & S4 stages.

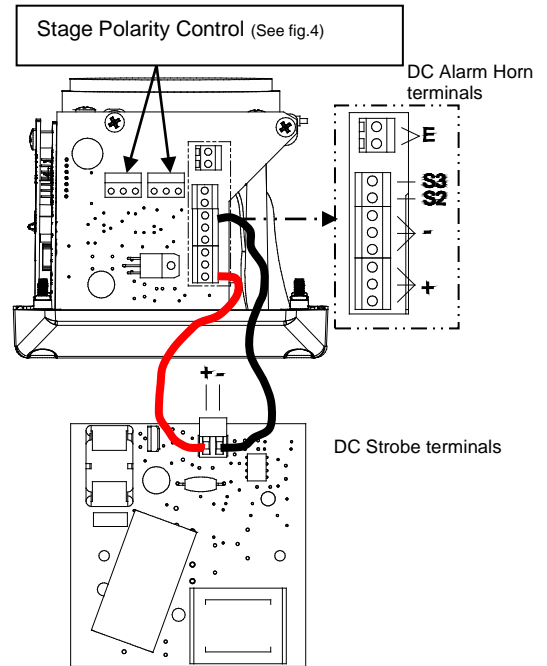

Fig. 8 DC Terminals

## 10) Earthing

The unit has both internal and external earth terminals, (please see fig 3).

Internal earthing connections should be made to the internal earth terminal on the PCBA, (please see fig 5 for AC, fig 8 for DC). The earth conductor should be at least equal in size and rating to the incoming power conductors. The internal earth bonding wire connects the two PCBA earth terminal to the internal earth terminal in the enclosure back box.

External earth connections should be made to the M5 earth stud, using a ring crimp terminal to secure the earth conductor to the earth stud. The external earth conductor should be at least 4mm<sup>2</sup> in size. The external earth crimp ring should be located between the two M5 plain washers provided and securely locked down with the M5 spring washer and M5 nut.

## 11) End Of Line Monitoring (DC Units Only)

On D2x1 DC units, dc reverse line monitoring can be used if required. All DC units have a blocking diode fitted in their supply input lines. An end of line monitoring resistor can be connected across the +ve and -ve terminals. If an end of line resistor is used it must have the following values:-

## 24V DC Alarm Horn and Strobe

Minimum Resistance 3k9 ohms      Minimum wattage 0.5W  
Minimum Resistance 1k ohms      Minimum wattage 2.0W

## 48V DC Alarm Horn and Strobe

Minimum Resistance 15k ohms      Minimum wattage 0.5W  
Minimum Resistance 3k9 ohms      Minimum wattage 2.0W

The resistor must be connected directly across the +ve and -ve terminals of the sounder board only, as shown in the following drawing. Whilst keeping its leads as short as possible, a spacing of at least 1/16 inch (1.58mm) must be provided through air and over surfaces between uninsulated live parts.

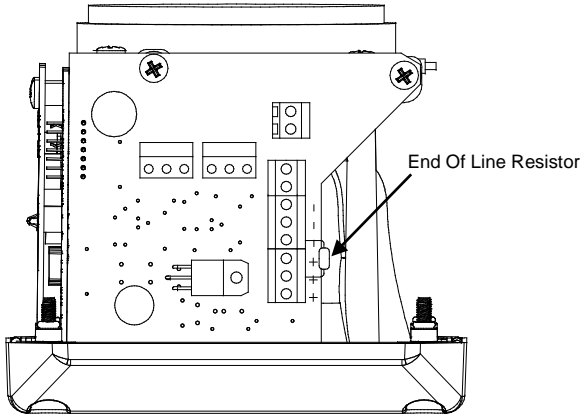
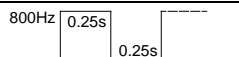
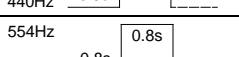
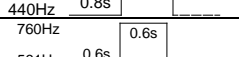
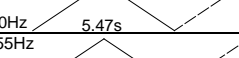
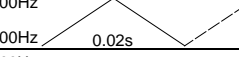
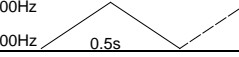

Fig. 9 End Of Line Resistor

**Tone Selection** – To select the required first stage tone set the tone switches 1 to 6 (see Fig 2) to the tone setting shown in the table below. The table also shows which 2<sup>nd</sup>, 3<sup>rd</sup> and 4<sup>th</sup> stage tones are available for use with the selected first stage tone if more than one tone output stage is required.

Stage 1 Tone No	Tone Description	Tone Visual	Switch Settings 1 2 3 4 5 6	Stage 2 Tone (S2)	Stage 3 Tone (S3)	Stage 4 Tone (S2 + S3)
1	1000Hz PFEER Toxic Gas	1000Hz _____	0 0 0 0 0	3	2	44
2	1200/500Hz @ 1Hz DIN / PFEER P.T.A.P.	1200Hz 1s 500Hz 1s	1 0 0 0 0	1	3	44
3	1000Hz @ 0.5Hz(1s on, 1s off) PFEER Gen. Alarm	1000Hz 1s 1s	0 1 0 0 0	1	2	44
4	1.4KHz-1.6KHz 1s, 1.6KHz-1.4KHz 0.5s NF C 48-265	1600Hz 0.5s 1400Hz 1s	1 1 0 0 0	44	24	1
5	544Hz(100mS)/440Hz (400mS) NF S 32-001	544Hz 0.1s 440Hz 0.4s	0 0 1 0 0	52	19	1
6	1500/500Hz - (0.5s on , 0.5s off) x3 + 1s gap AS4428	1500Hz 0.5s 500Hz 0.5s 0.5s 0.5s 1.5s	1 0 1 0 0	7	44	1
7	500-1500Hz Sweeping 2 sec on 1 sec off AS4428	1500Hz 500Hz 2s 1s	0 1 1 0 0	6	44	1
8	500/1200Hz @ 0.26Hz(3.3s on, 0.5s off) Netherlands - NEN 2575	1200Hz 500Hz 3.3s 0.5s	1 1 1 0 0	44	24	35
9	1000Hz (1s on, 1s off)x7 + (7s on, 1s off) IMO Code 1a	1000Hz 1s 1s 1s 1s 1s 1s 1s 7s	0 0 0 1 0 0	18	34	1
10	1000Hz (1s on, 1s off)x7 + (7s on, 1s off) IMO Code 1a	1000Hz 1s 1s 1s 1s 1s 1s 1s 7s	1 0 0 1 0 0	21	34	1
11	420Hz(0.5s on, 0.5s off)x3 + 1s gap ISO 8201 Temporal Pattern	420Hz 0.5s 0.5s 0.5s 1.5s	0 1 0 1 0 0	44	1	8
12	1000Hz(0.5s on, 0.5s off)x3 + 1s gap ISO 8201 Temporal Pattern	1000Hz 0.5s 0.5s 0.5s 1.5s	1 1 0 1 0 0	44	1	8
13	422/775Hz - (0.85 on, 0.5 off) x3 + 1s gap NFPA - Temporal Coded	775Hz 0.85s 422Hz 0.5s 0.85s 0.5s 0.85s 1.5s	0 0 1 1 0 0	44	1	8
14	1000/2000Hz @ 1Hz Singapore	2000Hz 1000Hz 1s	1 0 1 1 0 0	23	3	35
15	300Hz Continuous	300Hz _____	0 1 1 1 0 0	44	24	35
16	440Hz Continuous	440Hz _____	1 1 1 1 0 0	44	24	35
17	470Hz Continuous	470Hz _____	0 0 0 0 1 0	44	24	35
18	500Hz Continuous IMO code 2 (Low)	500Hz _____	1 0 0 0 1 0	44	24	35
19	554Hz Continuous	554Hz _____	0 1 0 0 1 0	64	24	35
20	660Hz Continuous	660Hz _____	1 1 0 0 1 0	44	24	35
21	800Hz IMO code 2 (High)	800Hz _____	0 0 1 0 1 0	44	24	35
22	1200Hz Continuous	1200Hz _____	1 0 1 0 1 0	44	24	35
23	2000Hz Continuous	2000Hz _____	0 1 1 0 1 0	15	3	35
24	2400Hz Continuous	2400Hz _____	1 1 1 0 1 0	48	20	35
25	440 @ 0.83Hz (50 cycles/minute) Intermittent	440Hz 0.6s 0.6s	0 0 0 1 1 0	1	44	8
26	470 @ 0.9Hz - 1.1s Intermittent	470Hz 0.55s 0.55s	1 0 0 1 1 0	1	44	8
27	470Hz @ 5Hz - (5 cycles/second) Intermittent	470Hz 0.1s 0.1s	0 1 0 1 1 0	1	44	8
28	544Hz @ 1.14Hz - 0.875s Intermittent	470Hz 0.43s 0.44s	1 1 0 1 1 0	44	24	8
29	655Hz @ 0.875Hz Intermittent	655Hz 0.57s 0.57s	0 0 1 1 1 0	1	44	8
30	660Hz @ 0.28Hz - 1.8sec on, 1.8sec off Intermittent	660Hz 1.8s 1.8s	1 0 1 1 1 0	44	24	8
31	660Hz @ 3.34Hz - 150mS on, 150mS off Intermittent	660Hz 0.15s 0.15s	0 1 1 1 1 0	30	24	8

32	745Hz @ 1Hz Intermittent		1 1 1 1 1 0	44	24	8
33	800Hz - 0.25sec on, 1 sec off Intermittent		0 0 0 0 0 1	53	24	8
34	800Hz @ 2Hz IMO code 3.a (High) Intermittent		1 0 0 0 0 1	56	24	8
35	1000Hz @ 1Hz Intermittent		0 1 0 0 0 1	44	24	8
36	2400Hz @ 1Hz Intermittent		1 1 0 0 0 1	21	24	8
37	2900Hz @ 5Hz Intermittent		0 0 1 0 0 1	53	24	8
38	363/518Hz @ 1Hz Alternating		1 0 1 0 0 1	1	8	19
39	450/500Hz @ 2Hz Alternating		0 1 1 0 0 1	1	8	19
40	554/440Hz @ 1Hz Alternating		1 1 1 0 0 1	44	24	19
41	554/440Hz @ 0.625Hz Alternating		0 0 0 1 0 1	1	8	19
42	561/760Hz @ 0.83Hz (50 cycles/minute) Alternating		1 0 0 1 0 1	1	8	19
43	780/600Hz @ 0.96Hz Alternating		0 1 0 1 0 1	1	8	19
44	800/1000Hz @ 2Hz Alternating		1 1 0 1 0 1	5	24	19
45	970/800Hz @ 2Hz Alternating		0 0 1 1 0 1	1	8	19
46	800/1000Hz @ 0.875Hz Alternating		1 0 1 1 0 1	53	24	19
47	2400/2900Hz @ 2Hz Alternating		0 1 1 1 0 1	57	24	19
48	500/1200Hz @ 0.3Hz Sweeping		1 1 1 1 0 1	44	24	12
49	560/1055Hz @ 0.18Hz Sweeping		0 0 0 0 1 1	44	24	12
50	560/1055Hz @ 3.3Hz Sweeping		1 0 0 0 1 1	44	24	12
51	600/1250Hz @ 0.125Hz Sweeping		0 1 0 0 1 1	44	24	12
52	660/1200Hz @ 1Hz Sweeping		1 1 0 0 1 1	64	24	12
53	800/1000Hz @ 1Hz Sweeping		0 0 1 0 1 1	56	24	12
54	800/1000Hz @ 7Hz Sweeping		1 0 1 0 1 1	57	24	12
55	800/1000Hz @ 50Hz Sweeping		0 1 1 0 1 1	54	24	12
56	2400/2900Hz @ 7Hz Sweeping		1 1 1 0 1 1	57	24	12
57	2400/2900Hz @ 1Hz Sweeping		0 0 0 1 1 1	47	24	12
58	2400/2900Hz @ 50Hz Sweeping		1 0 0 1 1 1	54	24	12
59	2500/3000Hz @ 2Hz Sweeping		0 1 0 1 1 1	44	24	12
60	2500/3000Hz @ 7.7Hz Sweeping		1 1 0 1 1 1	44	24	12
61	800Hz Motor Siren		0 0 1 1 1 1	44	24	12
62	1200Hz Motor Siren		1 0 1 1 1 1	44	24	12
63	2400Hz Motor Siren		0 1 1 1 1 1	44	24	12
64	Simulated Bell		1 1 1 1 1 1	44	21	12