

**DETERMINATOR
(and REMEDIATOR)
FIXED POINT
INFRARED
COMBUSTIBLE
HYDROCARBON
DETECTOR HEAD**

(patent pending)

OPERATIONS MANUAL

Part Number 900-105

Revision C (4)

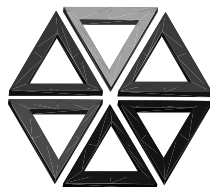

DELPHIAN CORPORATION

220 Pegasus Avenue, Northvale, NJ 07647

(201) 767-7300 fax (201) 767-1741

www.delphian.com

Table of Contents

1.	Introduction & Overview	6
1.1	General Description	6
1.2	Limited Warranty	8
1.3	Warnings	9
1.4	Markings	10
1.5	Installation Precautions	10
1.6	Compatibility	11
1.7	Unpacking	11
1.8	Storage	11
1.9	User Maintenance and Record Keeping	12
1.10	Approvals	12
2.	Detecting Gas Using Infrared Radiation	13
2.1.	Infrared Fundamentals	13
2.2	The Nature of Infrared Radiation	13
2.3	Measurement of Infrared Radiation	14
2.4	Electromagnetic Spectrum	14
2.5	How Radiation Reacts With Matter	15
2.6	How Infrared Gas Detectors Work	15
2.7	Using IR to Detect Combustible Gases	17
2.8	Open Path vs Point Sensors	17

©2006 Delphian Corporation

900-105c(4) FPIR Determinator (and Remediator) Detector Head (patent pending) Operations Manual

All rights reserved. Printed in the United States.

This publication may not be reproduced, stored in a retrieval system or transmitted in whole or in part, in any form or by any means, electronic, mechanical, photocopying, recording, or otherwise, without the prior written permission of Delphian Corporation, 220 Pegasus Avenue, Northvale, NJ 07647. <http://www.delphian.com>

3.	Theory of Operation	20
3.1	Combustible Gas Basics	20
3.2	Infrared vs. Catalytic Sensors	20
3.3	Sensor Operating Principle	22
3.4	Sensor Interfering and Desensitizing Agents	23
3.5	IR Processor Operation	24
3.6	Determination Table & Transfer Factors	25
4.	Installation	26
4.1	Wire Size Information	26
4.2	Installing the Processor, Interface and Sensor	28
4.3	Installing the Sensor	29
4.4	Installing the Interface Module	30
4.5	Installing the Processor Module	31
4.6	Installing the Optional SLAM Relay Module	31
4.7	Preparing the System for Initial Use	33
4.8	Suggested Sensor Location Considerations	33
5.	Configuring and Using The FPIR Detector Head	36
5.1	StandAlone Description	36
5.2	StandAlone Components	36
5.3	StandAlone Operation	36
5.4	Initial System Start-up	36
5.5	Setting Gas Alarms	37
5.6	Programming	37
5.7	Elevation Setup	40
5.8	Programming the Elevation	40
5.9	Choosing Gases to Monitor	40
5.10	Programming Gases	41
5.11	Monitoring Sensor Health	41
5.12	Sensor Display	42

6.	Maintenance & System Checks	43
6.1	Routine Maintenance	43
6.2	Sensor Operation Test Procedures	45
6.3	How to Use the Flow Gas System	45
6.4	How to Adjust the Zero	45
6.5	How to Test Sensor Operation	46
7.	Troubleshooting & Repair	47
7.1	Warning Codes	47
7.2	General Trouble Shooting Guide	47
7.3	Cleaning the optics	48
8.	Specifications	50
9.	Part Numbers and Suggested Spares	52
	Index	53

DRAWINGS

Figure 1: FPIR Detector Head (Drawing # 995302).....	6
Figure 2: FPIR Detector Head In Sections (Drawing # 995303).....	7
Figure 3: Infrared Spectral Absorbance	13
Figure 4 Wave Model	14
Figure 5: Absorbance Spectrum of Propane between 2.5 and 3.9 Micrometers	14
Figure 6 Methane Graph	18
Figure 7: Ethylene Graph	19
Figure 8: Ethanol Graph	19
Figure 9: Typical FPIR Installation and Configuration (Drawing # 995304)	27
Figure 10: Installing the FPIR Sensor (Drawing # 995306)	28
Figure 11: Electrical Conduit Seal (Drawing # 995305)	29
Figure 12: Outline of FPIR Sensor Housing with Window (Drawing # 364333)	30
Figure 13: SLAM Wiring and Relay Layout (Drawing # 995196)	31
Figure 14: Wiring Diagrams for the Flexirack Systems (Drawings 995336 & 995337)	32
Figure 15: Wiring Diagram, FPIR StandAlone System (Drawing # 995309)	33
Figure 16: Processor Face	37
Figure 17: Configuration Tool (Calibrator) (Drawing # 995311)	39
Figure 18: Flow Gas Calibration System (Drawing # 995307)	44
Figure 19: Relationship between the input and the output: mA to LEL Graph	48

TABLES

Table 1: Comparison Between Delphian IR Sensors and Delphian Catalytic Beads	21
Table 2: Recommended Cable Length Between Control Device and Detector Head	26
Table 3: Alarm Setpoint Programming of the Determinator	38
Table 4: Programmable Alarms	40
Table 5: Flowchart for Altitude Programming	41
Table 6: Determination Table for IR Detector	42
Table 7: 4 - 20 mA Signal Current Codes and Fatal Error Alarms	47
Table 8: List of Display Messages and Their Meanings	49

1. Introduction & Overview

This manual furnishes guidance to the informed user on how to install, operate, and service the Delphian Fixed Point InfraRed hydrocarbon detector heads: the *Determinator*, Model 850 for percent LEL detection and the *Remediator*, Model 855 for percent by volume detection. If used with a SAGE® or Delphian controller such as the DC550 system this document is considered an integral part of the Owners Manual for that system. If used as a Stand Alone detector head with a PLC or DCS this operation manual is the only document required.

This manual cannot, however, take the place of good engineering judgment. The user must bear the ultimate responsibility to ensure that the system, of which the detector head is a part, meets the requirements of the applicable regulating agency(s) having jurisdiction for the particular location selected and that the system is compatible with the environmental conditions (e.g. humidity, temperature, atmospheric contaminants, etc.) in

which the system is to operate. Hazardous locations in the United States are defined by the National Electrical Code (NEC), NFPA 70, Article 500. Hazardous locations in Canada are defined by the Canadian Electrical Code (CEC). Hazardous locations in Europe are defined by the International Electrotechnical Commission (IEC) or by the European Community for Electrotechnical Standardization (CENELEC). It is important that the detector head be checked out and installed by qualified personnel and that the group responsible for maintenance and sensor calibration be qualified and clearly defined.

This manual should be thoroughly read and understood before proceeding to use or install the detector head.

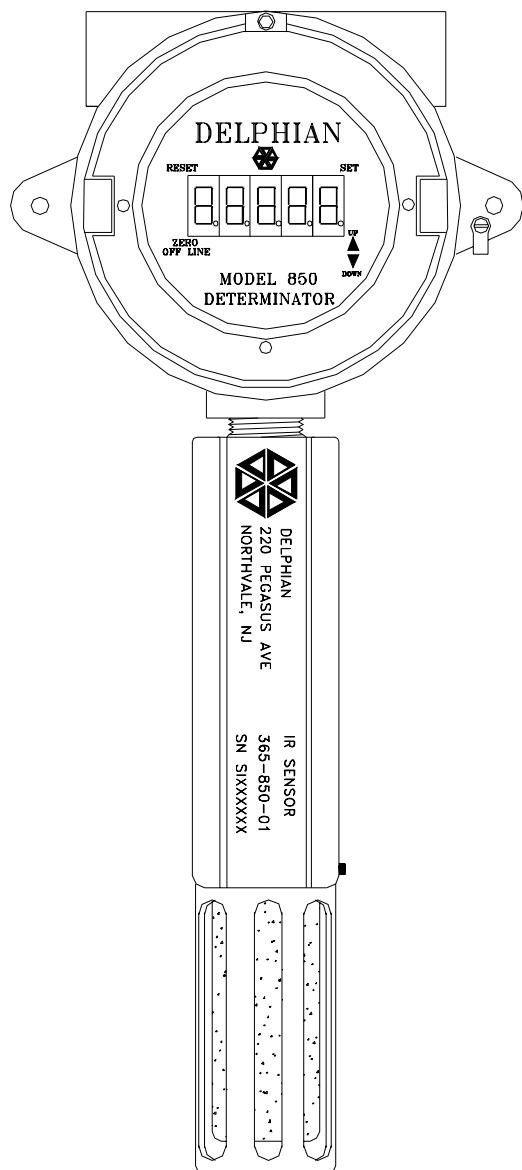
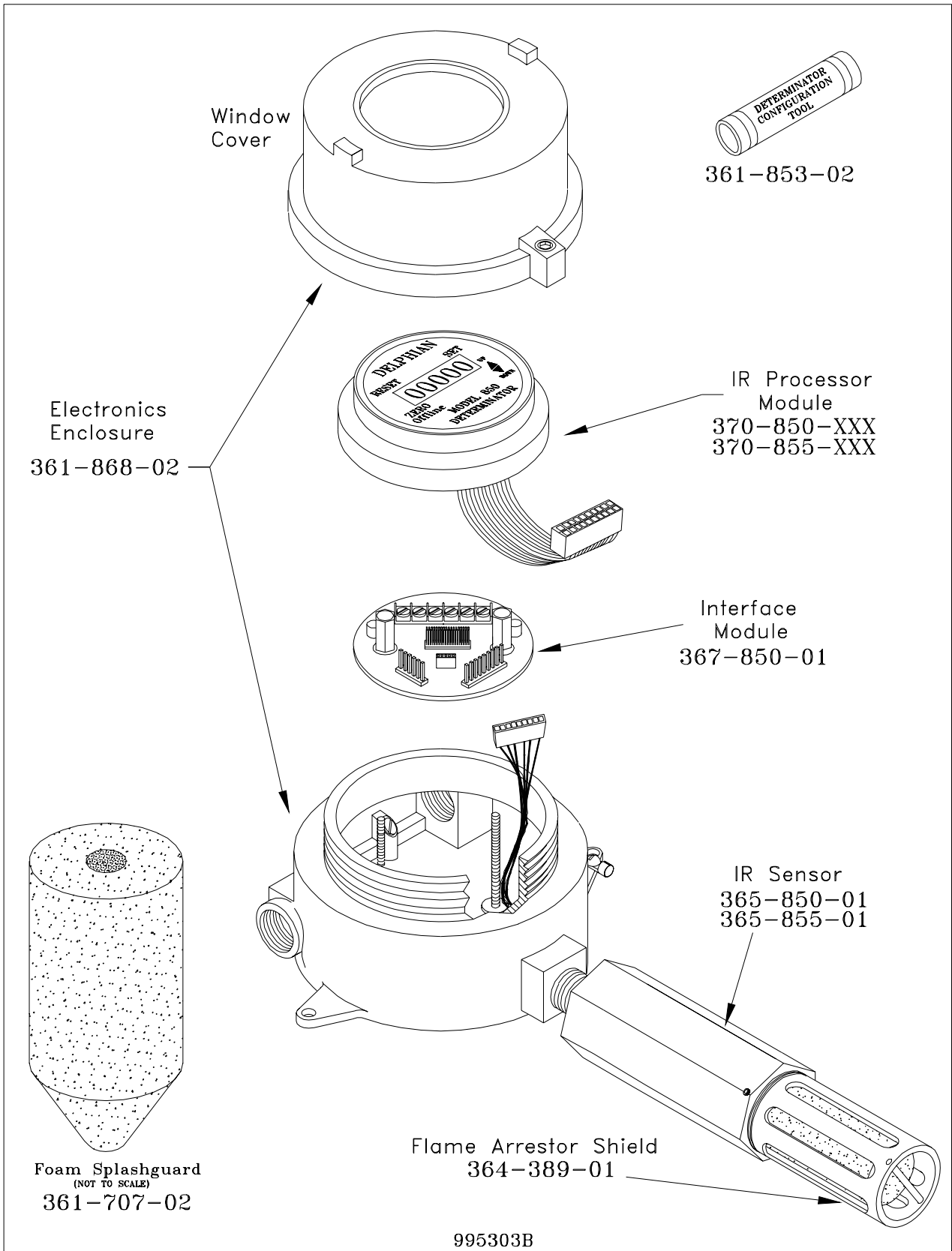

Figure 1: FPIR Detector Head (Drawing # 995302)

1.1 General Description

The **Detector Head** is the gas-responsive portion of a multipart gas detection instrument. It is intended to be located in the area where sensing the presence of gases is desired. The Detector Head transmits electrical signals to a Control Unit such as a PLC, DCS, Delphian Controller or Delphian Sage Computer System. The Detector Head comprises the electro-optical sensing assembly, called *IR Sensor*, the electronic processing and communication assembly, called *IR Processor Module* and a quick interconnection board, called the *Interface Module*. Both modules and the sensor are housed in explosion proof enclosures. The IR Detector Head is intended for use in a fixed installation, as a continuous monitor for combustible hydrocarbon gas or vapor in air. The Delphian FPIR CHC sensor is only sensitive to hydrocarbon gases and vapors. It can be used as a standalone detector or connected to a control unit or used with the optional SLAM relay module.

The IR Sensor includes an explosion proof metal housing which contains the optical detecting system and incorporates a flame arrester. The sensor is screwed



995303B

Figure 2: FPIR Detector Head In Sections (Drawing # 995303)

directly into the conduit box that contains the processor module. The flame arrestor can be removed with a special tool for replacement or cleaning of the flame arrestor and optics. This can be done by first removing the flame arrestor guard by loosening the allen screw. The electronic circuitry is potted for protection from the environment and for long service life. The sensor need not be disassembled. Only the heating element and the light bulb on the sensor under the flame arrestor may be replaced.

The Determinator (Remediator) assembly is housed in an explosion proof conduit box that contains:

1. The Processor Module
2. The Interface Module (which allows wiring connections between the sensor, the processor and its control device)

NOTE: Any optional communications module or alarm relay module (SLAM) is typically housed in a separate attached housing.

Sealed in waterproof encapsulant, the processor contains the electronics necessary to operate the sensor and the digital display. The conduit box provides mounting facilities for the IR Sensor and for a minimum of one $\frac{3}{4}$ " conduit, to be supplied and installed by the user.

NOTE: The area must be declassified before removing the sensor flame arrestor, the sensor from the conduit box, or when opening the top of the conduit box for access to the electronics.

A number of options are available for the detector head. Some of these are:

- Foam Splash/Dust Guard (to help protect against wind, water & dirt)
- Ported Adapters
- Reclamation Adaptor
- Relay Module (SLAM) + Conduit Box
- Zero Test Gas
- Methane Test Gas
- Optics Cleaning Spray

1.2 Limited Warranty

THE FOLLOWING WARRANTY IS MADE IN LIEU OF ALL OTHER WARRANTIES EXPRESS OR IMPLIED, INCLUDING BUT NOT LIMITED TO THE IMPLIED WARRANTIES OF MERCHANTABILITY AND FITNESS OF PURPOSE.

DELPHIAN CORPORATION SHALL UNDER NO CIRCUMSTANCES, AND NOT WITHSTANDING ANY FAILURE OF ESSENTIAL PURPOSE OF THE

SYSTEM OR OF ANY LIMITED REMEDY, BE LIABLE FOR COSTS OF PROCUREMENT OF SUBSTITUTE PRODUCTS OR SERVICES, OR FOR ANY INDIRECT, SPECIAL, INCIDENTAL, OR CONSEQUENTIAL DAMAGES WHETHER BASED UPON CONTRACT, TORT, OR ANY OTHER LEGAL THEORY, INCLUDING, BUT NOT LIMITED TO, ANY LOST PROFITS OR ANY THIRD PARTY CLAIMS AGAINST THE USER (CUSTOMER) ARISING FROM THE SYSTEM'S OR DELPHIAN CORPORATION'S PERFORMANCE OR NONPERFORMANCE.

Delphian warrants the DETECTOR HEAD AND ASSOCIATED ELECTRONICS to be free from defects in workmanship or material under normal use and service for two (2) years from the date of shipment.

Delphian's only obligation shall be to repair or replace free of charge any component that fails during the warranty period, providing the failure has been promptly reported in writing to Delphian.

Final determination of the responsibility for malfunctioning products will be made by Delphian.

The user assumes all liability for the use or misuse of the products by its employees or by other persons, including (but not limited to) consultants and contractors. All warranties are contingent upon proper use in the application for which the product was intended. The warranty does not cover products which have been modified or repaired without Delphian's written approval, or which have been subjected to neglect, accident, improper installation, improper or long storage, improper application, or on which the original identification marks have been removed.

1.2.1 Additional Limitations on the Sensor and Associated Electronics Warranty

Delphian does not assume any responsibility or liability for misuse or breakage of the sensor by the customer or by its employees, contractors or by other personnel. The warranty does not apply to any sensor which has been subjected to misuse, abuse, improper installation, or negligence in use, storage, transportation, or handling. Broken sensors, which appear to have been mistreated during shipment, should be immediately reported to Delphian.

1.2.2 Additional Warranty Disclaimer

The more frequently a system is checked, the greater will be the system's reliability.

For the highest reliability, a completely redundant system is necessary.

The detector head is intended to determine if certain minimum hydrocarbon gas concentrations exist at a single point (sensor location) in space. The sensor will not sense all explosive gases or concentrations of gas that do not come in contact with the sensor. Concentration readings should not be relied upon to provide more than an upscale or downscale trend in gas concentration. This sensor is not intended for use as an analyzer or process monitor. Its only function is to give an indication of the gas concentration at the sensor. Gas type determinations are a best guess and should be used only as an indication.

EXCEPT AS SPECIFICALLY PROVIDED ABOVE, DELPHIAN CORPORATION DISCLAIMS ALL OTHER WARRANTIES WITH REGARD TO THE PRODUCTS OR SYSTEM AND SHALL NOT BE LIABLE OR RESPONSIBLE FOR ANY LOSS, DAMAGE, OR LIABILITY DIRECT, INDIRECT, INCIDENTAL, SPECIAL OR CONSEQUENTIAL ARISING OUT OF OR IN CONNECTION WITH THE SALE, USE/MISUSE, PERFORMANCE OR THE INABILITY TO USE THE PRODUCTS BY THE USER.

1.3 Warnings

BECAUSE OF THE DANGEROUS NATURE OF THE GASES TO BE MONITORED, SPECIAL OPERATING CONSIDERATIONS ARE INVOLVED. BE SURE TO READ ALL OF THE WARNINGS IN THIS SECTION AND IN THIS MANUAL CAREFULLY. THIS SECTION DOES NOT CONTAIN ALL OF THE WARNINGS IN THIS MANUAL, NOR IS THERE ANY GUARANTEE THAT ALL APPLICABLE WARNINGS ARE CONTAINED IN THIS MANUAL OR IN OTHER DELPHIAN MANUALS.

WARNING: THIS OPERATIONS MANUAL DESCRIBES ONLY THE OPERATION OF THE IR DETECTOR HEAD. THIS DOCUMENT IS NOT INTENDED TO BE USED BY ITSELF WHEN USED WITH SAGE OR FLEXIRACK SYSTEMS. IT IS VERY IMPORTANT THAT YOU READ AND UNDERSTAND THE OWNER'S MANUAL AND THIS OPERATION MANUAL BEFORE INSTALLING OR OPERATING OR SERVICING THIS EQUIPMENT. IF ANY INSTRUCTION IS UNCLEAR, CALL

DELPHIAN TOLL FREE AT 1-800-288-3647 BEFORE PROCEEDING.

WARNING: If products are suspected of being damaged or defective, do not install or operate. Call Delphian Customer Service for a return material authorization number (RMA#). Damaged or defective products should be shipped prepaid, with the return material authorization number plainly visible on the outside of the carton, to the Delphian plant or to the authorized repair service center specified by Delphian Customer Service.

WARNING: All individuals whose safety is related to this equipment must be instructed carefully about its operation and limitations as well as about the risks of combustible gases and explosions.

WARNING: In the event that the system is used to detect a gas other than the ones which have been included in the sensor's determination table (see Chapter 3 for details), there can be no guarantee that an appropriate alarm will occur when a flammable concentration of the actual gas to be detected appears.

WARNING: To avoid sampling losses, for example, when using ported sensors, only sample lines recommended by Delphian or known to the user as being compatible with the environment should be used. Some materials are also sensitive to ultraviolet radiation and high temperatures.

WARNING: DESENSITIZING & INTERFERING AGENTS (BLOCKING, INHIBITING, CONTAMINATING OR POISONING GASES)

Most combustible hydrocarbon gases and vapors are interfering gases. The presence of many (interference) gases may cause the detector head to provide misleading readings. Acetylene and high concentrations of ammonia will block the operation of the sensor and may cause a fail indication.

WARNING: The sensor is designed to shed water. However, if the flame arrestor gets wet, the sensor may not function properly until it is dry. If the sensing system gets wet, it may act unreliably until it becomes dry again.

WARNING: The flame arrestor shield must always be installed on the flame arrestor.

WARNING: This sensor must be maintained on a regular basis. The optics should be cleaned when necessary and the zero should be checked on a regular

scheduled basis. Sensors, which require substantial adjustment at zero tests, should be monitored closely. When a sensor is first installed, it should be verified that normal conditions exist by checking frequently, before deciding to go to longer intervals between system checks. *NOT ALL SYSTEM FAULTS WILL CAUSE A FAIL SIGNAL.* A SYSTEM CHECK WITH COMBUSTIBLE GAS IS THE ONLY WAY TO BE SURE THE SYSTEM WORKS PROPERLY. PROPER SYSTEM CHECKS IS YOUR PRIMARY METHOD OF INSURING CORRECT SYSTEM RESPONSE.

WARNING: Not all options or accessories have been tested or approved by FM Approvals, BASEEFA or CSA.

WARNING: THE DATA AND SUGGESTIONS IN THIS MANUAL ARE BASED ON INFORMATION WE BELIEVE TO BE RELIABLE. THEY ARE OFFERED IN GOOD FAITH BUT WITHOUT GUARANTEE. THE CONDITIONS, MAINTENANCE AND METHOD OF USE OF OUR PRODUCTS ARE BEYOND OUR CONTROL. TO OBTAIN THE MAXIMUM VALUE, THE USER MUST RECOGNIZE HIS RESPONSIBILITY. NOTHING CAN SUBSTITUTE FOR GOOD ENGINEERING JUDGMENT AND COMMON SENSE. EVEN WHEN INSTALLED AND OPERATED BY QUALIFIED PEOPLE, DO NOT EXPECT TO DETECT DANGEROUS GAS LEVELS IN ALL OF THE CONDITIONS THEORETICALLY POSSIBLE.

1.4 Markings

These markings are for safety. They may also be required to maintain testing agency approval. The markings should be placed in a location at the detector head where they will be visible after installation and in direct sight during the routine periodic calibration and servicing. The user should insure that the markings are on clearly legible, visible and permanent labels or tags.

1. The words “CAUTION” and “ATTENTION” shall be in capital letters at least 3 mm high and the balance of the wording shall be in capital letters at least 2.5 mm high. These markings are:

“CAUTION: FOR SAFETY REASONS THIS EQUIPMENT MUST BE OPERATED AND SERVICED BY QUALIFIED PERSONNEL ONLY. READ AND UNDERSTAND INSTRUCTION MANUALS COMPLETELY BEFORE OPERATING OR SERVICING.” and

“ATTENTION: POUR DES RAISONS DE

SÉCURITÉ, CET ÉQUIPEMENT DOIT ÊTRE UTILISÉ, ENTRETENU ET RÉPARÉ UNIQUEMENT PAR UN PERSONNEL QUALIFIÉ. ÉTUDIEZ LE MANUEL D’INSTRUCTIONS EN ENTIEN AVANT D’UTILISER, ENTRETENIR OU DE RÉPARER L’ÉQUIPEMENT.”

2. At the detector head, which is an explosion proof assembly, these markings should appear:

“CAUTION - THIS AREA MUST BE KNOWN TO BE FREE OF FLAMMABLE CONCENTRATIONS PRIOR TO OPENING THIS ENCLOSURE.” These words should be in capital letters at least 5.0 mm high and marked in a permanent manner. The marking shall be conspicuously visible prior to removal of the cover.

3. The temperature range within which the detector head will perform (the most restrictive temperature range between the electronics and the sensor) should appear in a clearly legible, visible, and permanent manner at each detector head.

TEMPERATURE RANGE:

The Detector Head is not intended to be used in temperatures below -13 F (-25 C) nor above +158 F (+70 C). Consult Delphian before use in areas suspected of being above or below these limits.

1.5 Installation Precautions

1. The sensor is intended to be mounted in a vertical position with the flame arrestor pointing down towards the floor or ground. **If it is mounted in any other position it may not work optimally.**

2. The detector head is designed and tested for use in explosive atmospheres. It is not suitable for highly corrosive atmospheres. Consult Delphian before using it in areas suspected of being corrosive atmospheres. Explosion-proof integrity cannot be maintained if the detector head is not installed in accordance with the National Electrical Code of acceptable practice for the specific class of hazardous atmosphere at the sensor. The flame arrestor, the sensor head, and the conduit box access cover must be completely screwed into place to maintain integrity.

3. It is recommended that when new sensors are first put into use, sensor accuracy be checked on a routine basis. If repetitive function checks show minimal deviation, then the period between checks may be extended. Likewise, if routine checks indicate excessive deviations the sensor should be returned to Delphian for repair/replacement. Because small amounts of com-

bustible gas in the air can cause unreliable readings, the use of “Zero Air” is recommended. Additionally, known methane-air mixtures may also be used as span gas to check the detector's function.

Flame Arrestor Precautions

The Delphian FPIR sensors are designed to be operated in their housing with Delphian sintered metal flame arrestors secured tightly in place.

Do not operate the sensor without the flame arrestor in place.

Do not operate the sensor without the flame arrestor shield in place.

Do not operate the sensor if the flame arrestor is damaged.

Do not paint or otherwise coat the flame arrestor.

Do not allow the flame arrestor to become wet or clogged with dust, mud etc.

Steam, other vapors, aerosols, or other materials may coat flame arrestors, impeding or blocking sample flow to the sensor. The passage of gas through the flame arrestor is essential. **Warning:** *There will be no alarm nor will a fault indication occur if the flame arrestor is clogged.* Frequent function checks and the use of Delphian splash guards are recommended if the atmosphere around the sensor is dirty or wet.

Entering Atmospheres Potentially Containing Toxic or Combustible Gases

Any atmosphere which potentially contains toxic gas such as hydrogen sulfide or carbon monoxide should be tested first from outside the area to establish safe levels before entry. In addition to testing for toxic gases, tests for oxygen deficiency and combustible gas should be required by the user and/or regulatory agency. Oxygen deficiency will not alter the readings of Delphian FPIR sensors but could alter the accuracy of portable gas detectors. Operators should always wear suitable breathing apparatus when entering an unknown atmosphere.

Use of Sensor Accessories

Safety and accuracy of gas detection instruments may be improved in certain environments through the use of appropriate accessories, such as the foam splash guard. Any and all such accessories must be installed and used in accordance with their manual.

CAUTION: Not all of these accessories have been approved or tested by CSA, BASEEFA or by FM Approvals and many will slow response time.

1.6 Compatibility

The Delphian FPIR Detector Head is compatible with the SAGE computerized gas detection system, Delphian controllers and the SLAM alarm module.

The Delphian FPIR CHC head incorporates a processor and interface module that provides analog current outputs of 1-5 mA or 4-20 mA and/or a digital RS-422/485 output.

The processor module features a multipurpose digital readout that displays gas concentration and gas type if a CHC is present at the sensor. The processor provides operator prompts during system checks as well as extensive system diagnostic messages.

1.7 Unpacking

Unpack the shipping carton(s) and determine whether the order is complete as received. In the event of shipment damage or for purposes of future correspondence, record the following in case of transit claim:

- purchase order number & date
- carrier waybill number & date
- date received
- serial number
- user ID number (if assigned).

Fill out and return Delphian’s warranty registration card. If the shipment is damaged, call Delphian’s toll free hot line number 1-800-288-3647, in NJ call 201-767-7300 and request a return authorization number from Customer Service.

1.8 Storage

When storing gas detection equipment, select a dry location. Water condensation or corrosive atmospheres can easily damage electronic or optical parts. Clean air environments such as offices would be a good place to store sensors and unpotted electronics. Leave the system components in their original containers or provide suitable protective covers.

Do not store the system where temperature or other environmental extremes may exceed the system’s specifications.

Before storage, and when removing the system from storage, be careful to check all system parts for any sign of corrosion or obvious damage.

If a component of the system has been stored for more than one year, it should be tested before being put into use.

1.9 User Maintenance and Record Keeping

It is recommended that the user:

1. Assign an equipment identification (control) number to each main assembly and
2. Maintain complete records--including periodic performance, and maintenance checks.
3. Maintain the reliability of gas detection instruments by assigning responsibility for their initial inspection and subsequent use, including maintenance, to a specific qualified individual or group. It is important that the Checkout Procedures be performed by qualified personnel--trained in the operation, maintenance, and repair of optical gas detection instruments—and that the group responsible for maintenance be clearly defined.

1.10 Approvals

The Detector Head is designed to meet FM Approvals and Canadian Standards Association (CSA) requirements. FM Approvals acceptance of standalone gas detection instruments does not include or imply approval of the control apparatus to which it may be connected and which may process the electronic signal for eventual end use. In order to retain FM Approvals acceptance of a gas detection system, the control instrument to which the subject stand-alone gas detector is connected must also be FM Approvals approved.

2. Detecting Gas Using Infrared Radiation

2.1. Infrared Fundamentals

Radiation in the wavelengths that the human eye can see is very limited. This radiation is called visible light. There are, however, a number of electronic detectors, that can detect wavelengths much longer and much shorter than is visible. In the visible range red is the longest visible wavelength and therefore light just beyond this is called infrared. Violet is the shortest visible wavelength. Light just shorter than visible is called ultraviolet.

2.2 The Nature of Infrared Radiation

Radiation is simply a field in space which has characteristics of frequency, velocity and power. This radiation is usually described in terms of its properties, using these models:

2.2.1 Wave Model

Refraction, dispersion, and similar effects are based on radiation behaving as an oscillating electromagnetic

field that travels through space with a wavelike motion. Most methods of measuring or describing light use the wave model.

2.2.2 Particle Model

Radiation can also act like a stream of discrete particles of energy. These particles are called photons. It is the photon model that accounts for most detector reaction and is the basis for the radiation's interaction with matter.

2.2.3 Ray Model

Light traveling from a light source through air, lenses, or other transparent substances and undergoes reflections at mirrors is completely described as rays. The wave model is unimportant in the description of imaging by lenses.

2.3 Measurement of Infrared Radiation

When radiation acts as a wave, it can be classified in

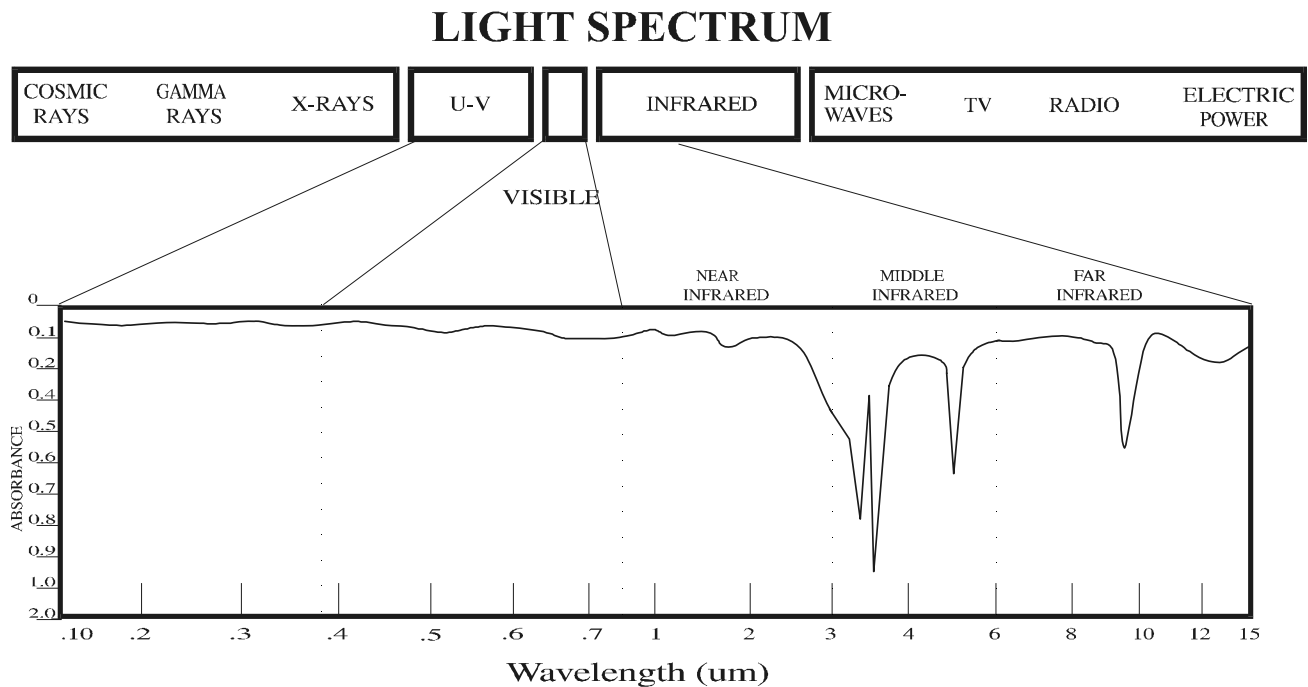

Figure 3: Infrared Spectral Absorbance

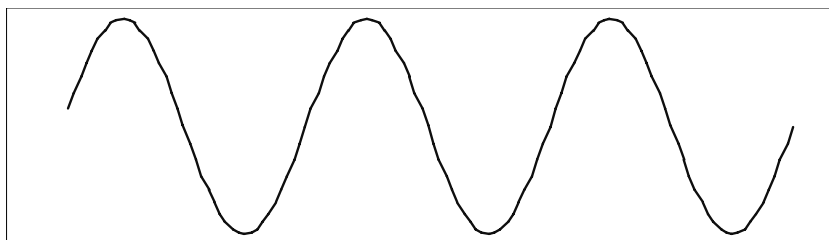

Figure 4 Wave Model

terms of wavelength or frequency. The common ways to measure or describe infrared radiation are:

2.3.1 Wavelengths

Wavelength is the most common measurement for IR radiation. Wavelength is the distance a wave travels during one period of oscillation, or stated differently the distance between adjacent crests or adjacent valleys of one wave. For infrared radiation, this distance is measured in micrometers (microns or μm) or nanometers (nm). For simplicity we will use wavelengths in microns to refer to IR energy.

2.3.2 Frequency

Frequency of infrared radiation is often measured in Wavenumbers. A Wavenumber (δ) is the number of wavelengths per centimeter and has reciprocal centimeters (cm^{-1}) as the unit of measure. For instance, 5.0 microns corresponds to 2000 reciprocal centimeters. For historical reasons this is the preferred unit in the science of Spectroscopy, which investigates the interaction of light waves with matter.

Although not used as often, IR radiation can also be measured by its time-frequency, the number of oscillations in one second, called Hertz (Hz). For instance, 5.0 microns corresponds to 6×10^{13} Hertz (=

60,000,000,000,000 per second). From this example it can be seen that cycles-per-second can be a rather large, unwieldy number.

There is a reciprocal relationship between frequency (or Wavenumbers) and wavelength. As the frequency of the wave decreases, the length of the wave increases. Both are linked by “c”, the speed of light, which is a universal constant of 3×10^8 m. In fact if we multiply a given wavelength with its frequency in Hertz we obtain the speed of light.

2.3.3 Energy

Electromagnetic radiation also has energy and power. One photon carries a very small amount of energy. As an example, one single photon of 5 micron radiation contains $0.000,000,000,000,000,004$ Watt-sec = 4×10^{-20} Ws. The energy of a photon is proportional to its frequency (Wavenumber) and inversely proportional to its wavelength.

2.4 Electromagnetic Spectrum

Infrared radiation is part of a broad spectrum of waves called the electromagnetic spectrum. This spectrum encompasses very short waves (cosmic rays) to light waves (ultraviolet, visible and infrared) to very long (heat, radio waves and AC electricity). Like visible

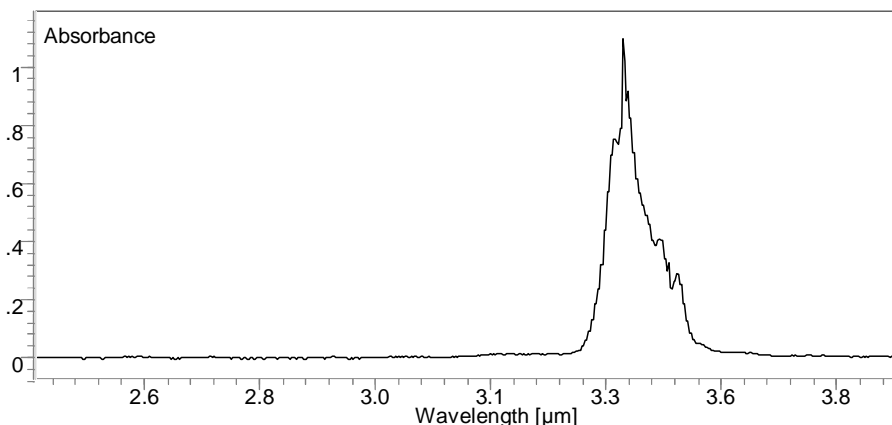

Figure 5: Absorbance Spectrum of Propane between 2.5 and 3.9 Micrometers

light, infrared radiation represents only a very small portion of this electromagnetic spectrum. The primary area of interest for gas detection is the mid-infrared region, which is generally defined as being 2.0 to 50 microns. Gas detection results from the interaction of this electromagnetic radiation with chemical matter.

2.5 How Radiation Reacts With Matter

Our environment shows color because of the selective absorption and reflection: A leaf appears green because much of the blue and red in the sun light that illuminates the leaf have been absorbed. Absorption of radiation has many different effects on substances depending on the wavelength of the radiation. Very short wave radiation, such as X-rays and cosmic rays penetrate into the core of an atom and cause ionization or even nuclear changes. Radiation that is closer to the visible portion is capable of breaking up large molecules into smaller fragments. When infrared light strikes a substance, the radiation is transmitted, reflected or absorbed in varying degrees, depending upon the substance and the wavelength of the radiation.

2.5.1 How Infrared Radiation Reacts With Matter

Since radiation is a form of energy, absorption of a photon by a molecule results in an increase in the energy content of the molecule. The absorbed energy causes an increased level of vibration or rotation. We are all familiar with the transfer of energy from one form to another, such as excitation of a bell resonance by a hammer strike. At the atomic and molecular level, however, there are some significant differences to our everyday experiences. When a molecule is excited by light, all of the energy of the light is used up or absorbed by the molecule. Each molecule can vibrate and rotate in certain patterns, and for each pattern there is an associated amount of energy of motion. A molecule can only absorb energy from a photon if the energy matches precisely the “energy state” of that molecule. This molecule is often called an oscillating dipole, for not all molecules can absorb energy from infrared light. Inert gases [He, Ne, Ar, Kr, Xe, Rn] or diatomic molecules composed of like atoms such as Hydrogen (H_2), Oxygen (O_2), Chlorine (Cl_2) and Nitrogen (N_2) only oscillate in high energy states. Consequently they can not absorb infrared radiation. They do absorb high energy radiation, such as ultraviolet and X-rays. They are said to be “transparent to infrared” or “infrared inactive”.

More complicated molecules like Carbon Dioxide (CO_2) or Methane (CH_4) exhibit oscillation modes that match the energy in infrared radiation to be infrared active. The oscillation modes might be asymmetrical stretching and bending motions.

It bears to stress again that photons interact with gasses only if their energy matches the energy difference needed to “lift” the oscillation mode of a molecule from its present state into another proper oscillation mode. For many gases there are a large number of photon energies in the mid-infrared range that can be absorbed by the gas molecules. Each molecule can bend, stretch, or twist in a large number of degrees. Yet, the energy match must be fulfilled, or the radiation will pass through the gas un-attenuated.

Each gas exhibits a very specific set of absorption wavelengths which depend on the strength of the chemical bonds between the atoms that make up the molecule. Change one element of the molecule and the absorption wavelengths will also change. It is this selective absorption of radiation which forms the basis for detecting a gas and for measuring its concentration. We call the gas-characteristic wavelength of absorption the “absorption band”.

2.6 How Infrared Gas Detectors Work

2.6.1 Essential Components

The essential components of an IR gas detection system are:

- Source of infrared radiation
- Detector capable of seeing the radiation
- Path between the detector and source open to the gas to be detected

Depending upon the design, the IR gas detection system may also need assorted light filters, choppers, mirrors, lenses or other optical elements.

Ideally a gas detector can just observe the light at the wavelength of the absorption band of the gas of interest (target gas). As long as the air does not contain any of the target gas the light level is constant. If the target gas enters the light beam the light level drops, and the magnitude of the light level drop serves as a measure of the amount of target gas in the light beam.

Unfortunately the IR gas detector world is not ideal. The light emitted into the gas detection volume varies with the age of the light source, the electrical supply, and various other influences. Furthermore the light detector also is prone to errors that need to be compensated. To make a long story short, a real world

IR gas detector is more complicated than the ideal sketched above and it comprises the following building blocks:

2.6.2. Chopping the Signal

To mitigate electronic drift the detector electronics measures the difference between dark (no light hitting the detector) and light (full energy hitting the detector). To achieve this effect, light between the source and the detector is chopped so that the detector's electronics can clearly differentiate between full light and no light. When gas in the path absorbs energy from the source, the detector receives less radiation than it normally would during the "light" phase. This reduction in radiation is used to measure the gas concentration. Chopping is usually accomplished by a mechanical device or electronically, such as turning the source on and off. There are advantages and disadvantages to both approaches.

2.6.3 Reference Signal

Even with a chopped signal, there are a number of factors which could cause a device to measure incorrectly. Changes in detector's sensitivity or the source strength could cause a device to miscalculate. As a result most designs have a reference channel to monitor system integrity. This reference is often a second detector and/or a second source which verifies the strength of the full light signal from the source. As a result of chopping the signal and incorporating a reference, IR devices are continuously checking their operation.

2.6.4 Path Length

Radiation from the source can be considered a beam of photons. The Beer-Bouguer Law states that the number of photons absorbed is directly proportional to the power of the photon beam and to the amount (number of molecules in the beam) of the gas to be detected. Therefore, the length of the path between the source and the detector can be a major determiner of the gas concentration range the instrument can detect. The longer the path length the more molecules of target gas will be between the light detector and the source and the more molecules the greater will be the absorption for small concentrations of gas. Conversely, with a longer path all of the light may be fully absorbed before the gas concentration reaches the desired maximum gas concentration and the instrument would be flooded. As can be surmised, the ideal path length is determined by the maximum concentration of gas that the instrument is

designed to detect.

2.6.5. Selective Absorption

As discussed earlier, one of the chief attributes of infrared absorption is its outstanding specificity. If only light of the proper frequency hits the detector, then any absorption will be caused by the gas to be detected. However, most sources produce radiation over a broad spectrum and most detectors see energy radiation over a broad spectrum. To be selective, therefore, energy from the source must be limited so that the detector sees mainly photons which will be absorbed by the target gas. Filters at the source and/or the detector are the primary means of selectively limiting the wavelength. This is called non-dispersive infrared. Dispersive infrared uses a grating, prism or other means of analyzing the wavelength content of an infrared beam.

Unfortunately, detectable gases do not have only one light frequency that will cause them to absorb. Most have a great number of absorption peaks, each of which is of varying strength and varying width. Furthermore the absorption peaks are substantially narrower than the best light filters available today. In many cases there are multiple gases that absorb light within any one light filter pass band. As a result designers seek to find an absorption point for the gas of interest which is strong enough to be seen and which will not also not shared by a gas which could cause false readings. If the wrong detection channel is chosen, other gases will interfere and cause erroneous signals. If the wrong wavelength for the reference channel is chosen, gases in the area could disturb the calibration of the device and cause it to misregister the target gas.

2.6.6 Light Detectors

There are a great variety of light detectors which can measure radiation in the mid-IR range. It goes without saying, that each has its own problems and benefits. There is no perfect detector. It is how the designer uses the benefits of the detector and copes with its problems that can cause one instrument to be more successful than another in any given application. Detectors can be grouped into several categories depending upon their mechanism of operation.

Thermal Detectors

Thermal detectors such as thermopiles, thermocouples or pyroelectric detectors operate by changing temperature when struck by a photon. The change in temperature results in an alteration of the detector's electrical properties which can be measured as a induced voltage.

Such detectors can be built for very wide spectral ranges.

Photoconductive Quantum Detectors

Quantum detectors such as lead salt (Lead Selenide or Lead Sulphide) detectors are excited directly when struck by a photon. This excitation can be measured as a decrease in resistance.

Photovoltaic Quantum Detectors

Photons striking photovoltaic detectors cause a voltage at the detector terminals. A number of detectors can be used either as photoconductors or as photovoltaic generators, depending on the electronic amplifier circuit.

Pneumatic (Photoacoustic)

The gas to be detected is trapped in an enclosed chamber. When a photon is absorbed by the gas it causes a rise in the temperature of the gas and a corresponding increase in gas pressure. A sensitive microphone is used to pickup the pressure fluctuation.

2.6.7 Operational Considerations

There are a number of specialized factors which must be taken into account in designing an infrared gas detector or any gas detector. Some of the most important are:

Temperature

Most infrared light detectors are very sensitive to temperature, with cold being the preferred temperature. In the presence of heat they lose sensitivity and/or drift depending upon the circumstances.

Humidity

Humidity is often a major interference with infrared systems. Water vapor is transparent to infrared from 3 to 4.6 Micron but shows significant absorption outside this band in the mid-infrared range. This absorption appears like gas to the detector and can cause false readings. In addition, water vapor can condense on the optics or in the path and cause the beam to be deflected or diffracted so that erroneous reading or instrument failure can occur.

Pressure

Infrared systems are also affected by changes in pressure. As pressure increases more molecules are packed into the path and therefore more infrared radiation is absorbed. At lower pressures, therefore, less radiation is absorbed for the same volume of gas. As a result, when there is a sudden change in barometric pressure, infrared instruments often produce erroneous absolute partial pressure readings. Therefore if a weather system comes through which changes the pressure, temperature and humidity, infrared systems often operate poorly.

2.7 Using IR to Detect Combustible Gases

2.7.1 Selectivity

The selective absorption of infrared, one of its primary benefits, can also be one of its primary problems. For instance a catalytic sensor can detect all combustible gases, however most IR devices can only detect the gas it was designed to detect. In most cases this is methane and a few other combustible (and some not combustible) gases which happen to share the absorption wavelength band. The only way to solve this selectively problem is to use multiple detectors in a device and/or use multiple devices each intended to detect a particular gas.

The Delphian FPIR uses three active light wavelengths as well as a reference wavelength to discriminate between the different combustible hydrocarbons. These hydrocarbons absorb the light to a greater or lesser degree depending upon the gas concentration and the specific gas molecule structure. Using determination tables stored in the IR processor module and sophisticated analytical algorithms the processor first computes the best match between the observed light absorption and the stored absorption characteristics in its determination tables. Based on this identification the processor calculates the correct quantity of the gas being detected and then calculates the LEL of the gas. This LEL is transmitted it on the 4-20 mA signal line. Delphian's approach to combustible gas detection is so unique that it has been patented. See Section 3 for more details on the operation of the Delphian IR Sensor. Figures 6, 7 and 8 are graphs which illustrate the raw data from each of the three active wavelengths for Ethanol, Ethylene and Methane.

2.8 Open Path vs Point Sensors

For fixed point products, the ideal path length can be engineered into the product. For instance, with methane detectors designed to detect 100% LEL, the ideal path length would be between four and seven inches. However, for open path products, the larger path lengths used often mean that the product is flooded well before reaching 100% LEL. For instance, with a path of 5 feet, an IR detector might not be able to detect more than 10% LEL of Methane before flooding, assuming a constant methane / air concentration everywhere between the light source and the light receiver.

In addition, open path detectors can see sources of infrared other than the one chosen by the manufacturer.

For instance, solar radiation, hydrocarbon flames, even flash bulbs produce broad spectrum infrared radiation which could trick detector, unless countermeasures are provided in the design.

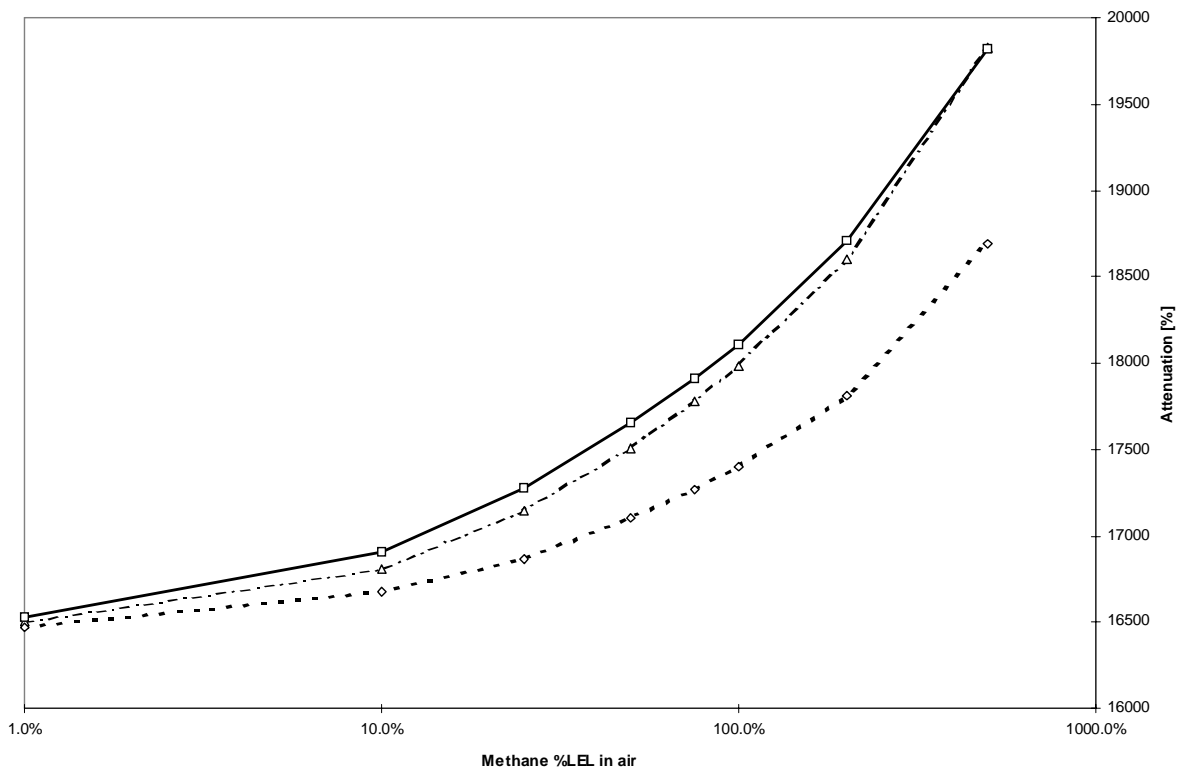

Figure 6 Methane Graph

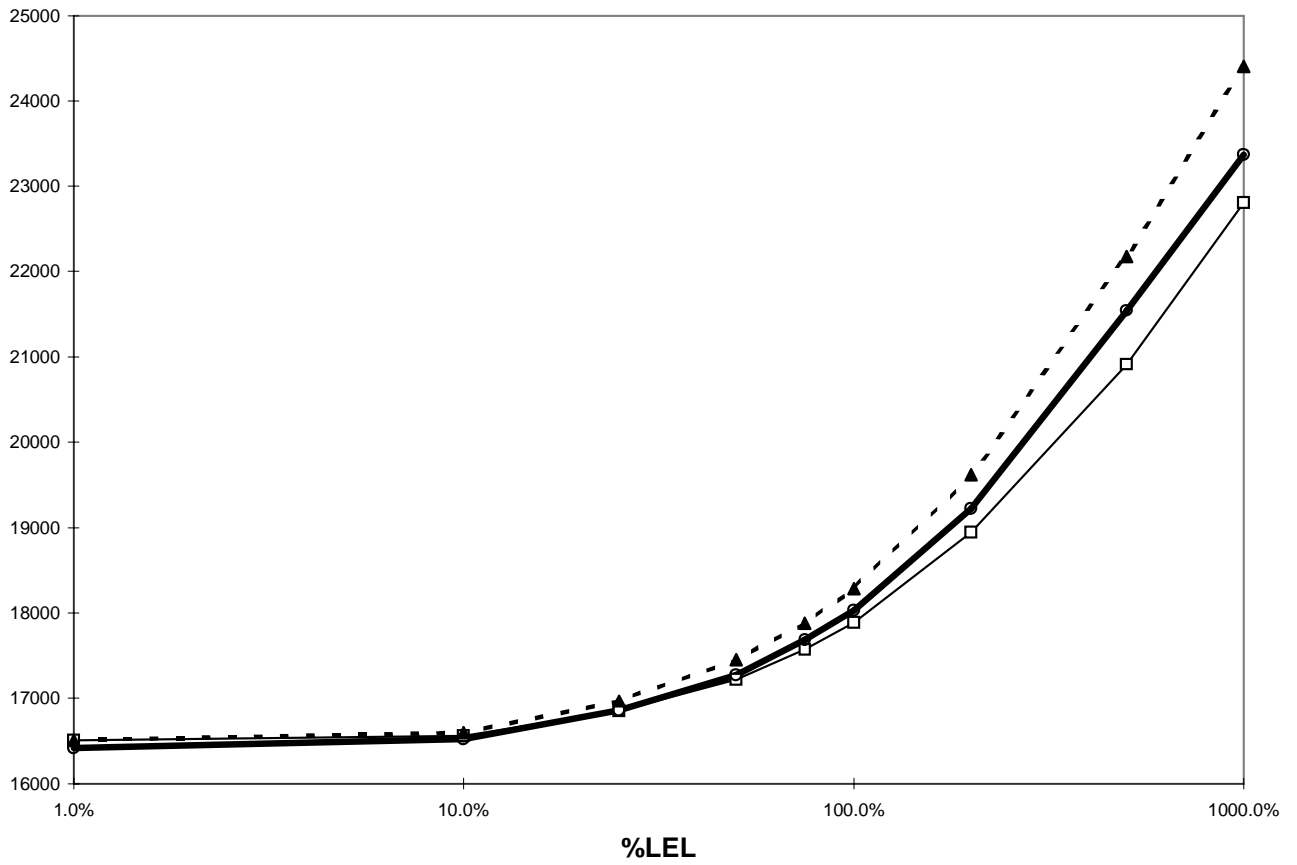

Figure 7: Ethylene Graph

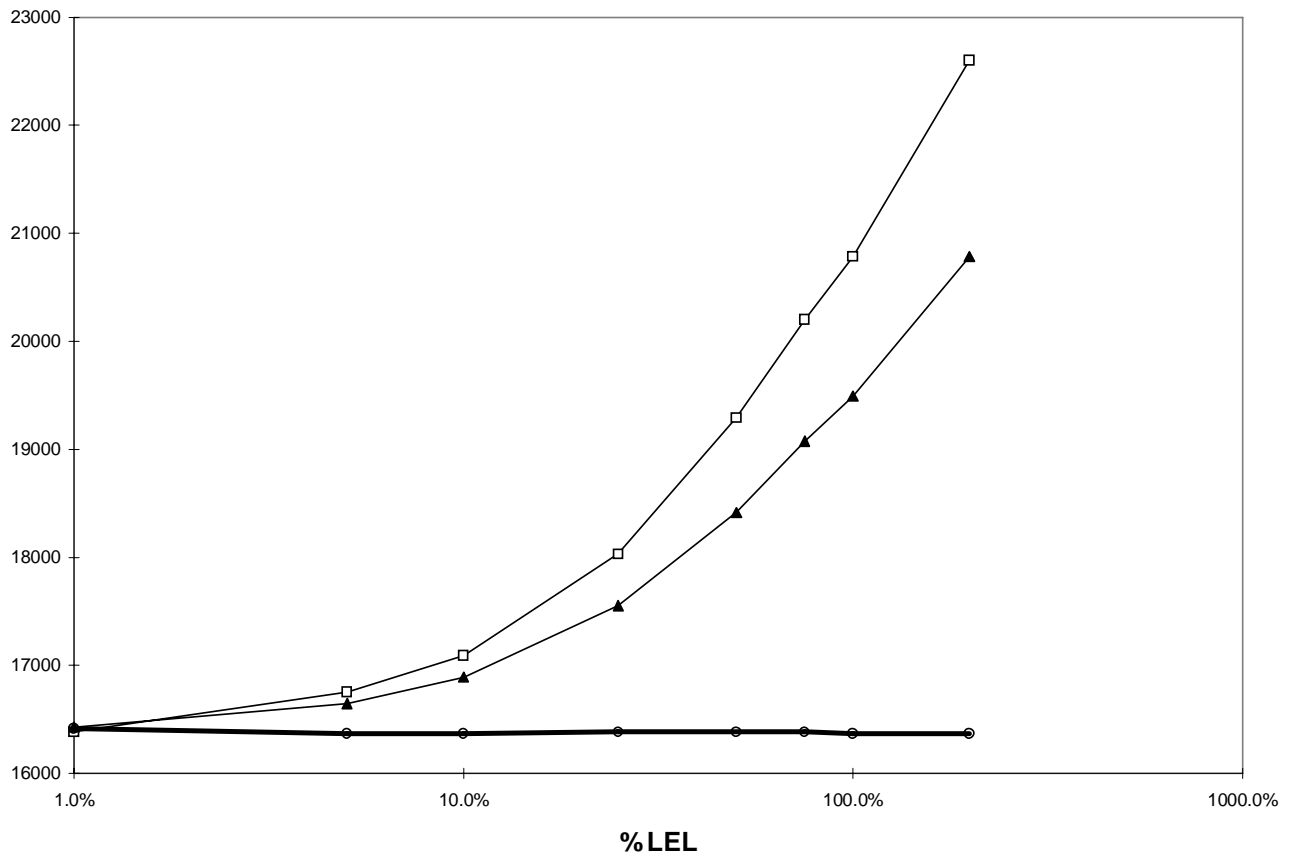

Figure 8: Ethanol Graph

3. Theory of Operation

3.1 Combustible Gas Basics

3.1.1 The Delphian FPIR CHC *Determinator* sensor is intended to provide the percentage of the Lower Explosive Limit (% LEL) readings for any one of the combustible gases stored in its data base. (See Table 6 Delphian document PN 364-335-01 Recognized Gas List (for the most up-to-date version go on the internet to www.delphian.com/determinator.htm). It is not intended to sense concentrations below 4% LEL nor is it intended to provide analytical quality concentration information. Note: Because some gases produce such a small signal, the sensor may not effectively differentiate between them until they reach a concentration of 10-20% LEL. The sensor is capable of estimating gas concentrations above 100% LEL, up to pure gas in many cases. Concentrations above 120% LEL are called "Overrange". They are only displayed on the digital display but are not transmitted proportionally on the current signal output line.

Combustible gas-air mixtures can be burned over a wide range of concentrations. For each gas there is a specific minimum concentration above which an ignition source will cause an explosion or flame front propagation. This is called the Lower Explosive Limit (LEL) of that gas or vapor. It is sometimes called the Lower Flammable Limit (LFL). The LEL depends on the gas. For most CHC's, this minimum concentration is between about 0.5% to about 15% by volume in air. The LEL concentration represents 100% on the Delphian system, or in other words, "100%" display already is compensated for the differences between the various CHC gases which can be identified by the detector. Some combustible gases are lighter than air, some are heavier. Before installing a sensor to monitor a CHC gas be sure the characteristics of the gas are known. Combustible gas monitors must have alarms to warn of potentially dangerous gas concentrations. Typical alarm settings are Low alarm = 20% LEL, Hi alarm = 40% LEL, HiHi alarm = 60% LEL. Only the user can judge whether these settings are appropriate. It is also important to follow the laws governing the monitoring of hazardous areas. Be thoroughly familiar with the theory of combustible gas detection

before attempting to operate this CHC detector head. Useful information can be found in the following publications:

1. Industrial Explosion Prevention and Protection, by Frank T. Bodurtha, McGraw-Hill, 1980.
2. Gas Monitoring Handbook, by Gerald Anderson and David Hadden, Avocet Press Inc, 1999
3. ISA Recommended Practice 12.13
4. NFPA 325M, Flammable Liquids, gases, volatile solids (NFPA, Batterymarch Park, Quincy MA.)

3.1.2 The Delphian FPIR *Remediator* sensor is intended to provide percentage by volume readings for any one of the combustible gases stored in its data base. It is not intended to sense concentrations below 0.2% by volume nor is it intended to provide analytical quality concentration information. The sensor is capable of displaying gas concentrations of most combustible hydrocarbons up to 100% by volume.

3.2 Infrared vs. Catalytic Sensors

3.2.1 Advantages of Infrared Detectors

Infrared detectors are immune to poisons

- consumables (source & detector) tend to outlast catalytic sensors
- because of its continuous self-monitoring design it needs to be calibrated less often
- more fail safe because the system is actively checking itself
- can often perform more reliably in high or varying flow conditions
- fewer interfering gases
- even if flooded, will not lose the signal it can detect

3.2.2 Advantages of Catalytic Sensors

Catalytic Sensors can perform more reliably in dusty/dirty atmospheres, because they are not as sensitive as optics to the buildup of industrial contaminants

- can perform more reliably in high temperature applications

Table 1: Comparison Between Delphian IR Sensors and Delphian Catalytic Beads for the Detection of Hydrocarbons

Comparison Between Delphian Infrared Sensors And Delphian Catalytic Beads For the Detection of Hydrocarbons		
	IR ABSORPTION-BASED SENSOR	CATALYTIC BEAD CHC SENSOR
Need for Oxygen	None	Needs 12-21% oxygen (air) for accuracy
Sensitive to Poisoning	Intrinsically unaffected by silicones, acids, bases, and other gases	Can be destroyed by coating or etching chemicals that impact the catalyst on the ceramic
Concentration range measured	4 to 120% LEL hydrocarbon 4 to 999% LEL signal output	0 to 100% LEL
Capability with adapted processing	Zero to pure CHC gas	Zero to UEL (upper explosive level)
Flooding	Not sensitive to flooding	Floods at levels greater than stoichiometric mixture with air
Moisture	Not affected	Not affected
Maximum Operating Temperature	70C limited by electronic circuitry and semiconductor sensor	85C, limited by electronic circuitry
Calibration Interval	Infrequent zero calibration Span calibration not required	30-60 days recommended
Useful Service Life In Poison Free Atmosphere	>5 years	2-3 years
Useful Service Life in CHC-laden atmosphere	>5 years	1-3 years (Delphian CHC bead not affected by CHC presence)
Recovery After CHC Exposure	Recovers quickly	Recovers quickly Competitive products may require calibration
Susceptible to Undetected Failure	More errors can be detected	Yes (flooding, poisoning, clogging)
Wind/Flow	Relatively insensitive to flow	Can be very sensitive to high air speeds.

- not significantly affected by changes in pressure
- Delphian's patented constant temperature circuit means their catalytic sensors are not affected by changes in humidity, however all catalytic sensors are less sensitive to humidity and condensation
- can detect all combustible hydrocarbons
- can detect hydrogen which is invisible to Infrared
- smaller footprint than infrared

3.3 Sensor Operating Principle

The Delphian Fixed Point Infrared (FPIR) Combustible Hydrocarbon (CHC) Sensor uses invisible light to probe the atmosphere for hydrocarbons. The detection process does not rely on the combustion of CHC and is independent of the fact that the gases of interest have enough oxygen to be combustible. Table 1 compares the Delphian FPIR Sensor to the Delphian Catalytic Bead Sensor.

3.3.1 The Science Behind the Sensor

All CHC gases have one or more hydrogen (H) atoms chemically bonded to a carbon (C) atom. The bond between the H and the C is elastic and the distance between the two atoms can oscillate. This oscillation can be excited by external forces much like a window pane can be set into sympathetic vibration by a passing truck. In the case of the C-H bond the oscillation is activated when radiation with a wavelength of about 3.3 micrometer (3.3 μm , 0.00012 inch) strikes the molecule. The precise wavelengths that interact with any one gas are unique for that gas. Every time a molecule “captures” radiation that excites the oscillation some light energy is lost/absorbed. It is this light loss that is used to measure the amount of hydrocarbon gas present. The radiation at 3.3 μm is qualitatively no different from visible light, except that human eyes can not “see” the light. For this reason we call this kind of radiation infrared (“beyond-red”) light.

On a practical level, infrared-based CHC gas sensors differ from catalytic bead sensors in the variation of their sensitivity to different gases relative to methane gas. Often the sensitivity to methane is used as the base line and sensitivity to other gases is characterized by a “transfer factor”. In this representation a catalytic bead has a transfer factor of 1 to methane. For most combustible gases a catalytic bead exhibits transfer factors between 0.6 and 2.5. For the common IR sensors with one reference and one active channel the transfer factors can easily vary in a range of 20 to 1. Therefore it is essential to know which gas is present at the sensor in order to obtain a reliable gas concentration in terms of

% LEL. The Delphian FPIR CHC sensor uses a patented approach that equalizes the transfer factors for many gases.

The Delphian Fixed Point IR sensor consists of a sample tube with openings at the bottom and the top. The atmosphere containing the combustible gas enters the sample tube through a bottom opening and exits through the top opening. The gas diffusion is enhanced by a patented heater at the base of the tube. A miniature light source at the bottom of the tube shines light into the sample tube. At the end of the tube opposite the light source is a light sensitive receiver with four custom light filters. Each light filter cuts a narrow slice out of the broad wavelength range coming from the light source. Three filters transmit light in neighboring slices of wavelengths that do interact with CHC gases, and one filter transmits only light that does not interact with CHC gases. The signals from the three detectors behind the interacting light filters are called the active channels, and the fourth signal from the detector behind the non-interacting light filter is the reference channel.

Most hydrocarbons exhibit characteristic ratios of interaction with IR light in the three wavelength slices. The microprocessor, which is an integral part of the Delphian sensor, evaluates the signals and deduces from the profile of the three active channels which hydrocarbon has entered the sample tube. Once the gas has been identified the % LEL is computed for that gas. The Delphian FPIR CHC sensor is trained to recognize the most common hydrocarbon gases and vapors. For the complete list see the Delphian Web site at www.delphian.com/determinator.htm. This list is also available in hard copy from Delphian. Ask Customer service for document 364-335-01.

WARNING: The IR-based sensor can accurately measure the concentration of only one CHC gas at one time. **A mixture of two or more CHC gases of concentrations above 4% LEL will be either misinterpreted by the instrument as a different gas than either of the present gases, or, more likely, the instrument may not identify the gas at all.** In this case the microprocessor computes a % LEL gas concentration based on a gas profile that provides the highest margin of safety (worst case). This kind of uncertainty can only occur if similar concentrations of different gases are present, such as 10% LEL of methane and 8% LEL of butane. A background of multiple gases, each in concentrations of less than 1% LEL should not severely impact the identification of a CHC at 15-20% LEL concentration.

3.4 Sensor Interfering and Desensitizing Agents

This section expands on the characteristic differences between catalytic bead sensors and IR-based CHC sensor. It will become clear that some of the phenomena of concern relative to the catalytic bead technology are of no consequence to our IR gas detector.

3.4.1 Sensor Interferences

General: An interfering gas is any gas or vapor other than the target gases which will cause the sensor to register a signal. In this context a target gas is understood as any of the hydrocarbon gases for which the FPIR processor has been programmed. Because of the design of the Delphian FPIR CHC sensor it is believed that all gases and vapors that contain at least one Hydrogen-Carbon bond will register a signal, irrespective of their propensity to form explosive gas mixtures with air. The 4-20 mA line does not afford any distinction between different gases. Only the local display at the sensor and the optional serial digital output of the sensor allow for identification of the specific gas signaled by the sensor.

3.4.2 Sensor Poisons

A “poison” of a combustible gas sensor is a vapor that reduces or completely eliminates the sensor’s sensitivity to the target gas. The Delphian FPIR CHC sensor is completely free of poisoning effects by chemicals. Extensive and continuous self-tests minimize the possibility of sensitivity loss from component degradation, see Section 5.11 Sensor Health Monitoring.

3.4.3 Sensor Blocking

Blocking is a condition in which the sensor does not register correctly, or completely misses the presence of a target gas at the sensor location. The most common reason for blocking is water submersion, or a clogged, corroded, or coated flame arrestor due to dust, mud and other particulate matter that blocks the small passages in the stainless steel flame arrestor.

Acetylene: Acetylene has been known to interfere with the measurement accuracy in IR-based CHC sensors. The wavelength used for the reference matches the absorption band of acetylene. Significant amounts of acetylene can cause lower LEL readings or can cause the sensor to go below zero. If the sensor drifts 10% below zero, the display will show FAIL LEL NEG and a fail warning will be transmitted on the 4-20mA line.

CAUTION: FM Approved Model 850 Determinator and SLAM Assembly are not approved for installation in locations with acetylene or hydrogen gas (Group A or B hazardous locations).

EMI/RFI:

The presence of EMI may cause incorrect operation.

Humidity:

The Delphian FPIR CHC sensor is not prone to blocking by high, or even condensing humidity because the heating element at the base of the probe tube maintains an elevated temperature in the measurement chamber, resulting in a relative humidity that is lower than in the atmosphere outside the sensor. However, immersion in water will block access to the probe volume and cause blocking. After immersion the sensor will recover.

Flooding:

Flooding of a catalytic combustible gas sensor is a condition in which the CHC concentration exceeds the upper explosive limit (UEL) and combustion can not take place. Even though the target gas is present in very high concentration the sensor indicates gas free atmosphere. The Delphian FPIR CHC sensor does not use combustion, hence flooding can not occur. Even though the Delphian FPIR CHC sensor will be limited to 23 mA on the 4-20 mA signal line to indicate “Overrange” for any gas concentration exceeding 120 %LEL, the local display will indicate gas concentrations up to 999% LEL. Still higher concentrations up to pure CHC gas are indicated by a flashing “999.”

Saturation:

Saturation is the condition in which the sensor fails to show an increase in gas concentration even if the gas concentration increases. Saturation of a single active channel IR-based CHC sensor occurs if the target gas becomes completely opaque at the active wavelength before the gas concentration has reached the desired measurement range, for example 120% LEL. Ethane, as an example, exhibits very strong absorption at 3 μm. The Delphian FPIR CHC sensor will not saturate at any gas concentration because of the three active channel design.

Warning: The Delphian FPIR CHC sensor is truly a **hydrocarbon ONLY** sensor. Other combustible gases, such as hydrogen or acetylene are not detected even if present in dangerous concentrations.

Warning: An offscale reading may indicate a flammable concentration.

3.4.4 Pressure and Altitude Considerations

The Delphian FPIR CHC sensor measures the amount of CHC in the probe volume. To convert this measurement into percent of lower explosive limit the measured amount of CHC is divided by the amount of air in the probe volume. The FPIR sensor does not measure the amount of air. Instead the air content is set constant based on the mean atmospheric pressure at the site of the sensor. This is a very good approximation for all normal conditions. To illustrate the point, consider the variations of air pressure over the days, weeks and seasons: the average atmospheric pressure at sea level is 29.92 in. of Hg. The pressure in a category 2 hurricane (110-mph wind) is at least 28.5 in. of Hg, or just under 5 percent lower than the average pressure. Therefore, if the FPIR shows 50%LEL methane during such a hurricane, the correct value would be 52.5%LEL, well within the specified accuracy of the sensor.

The situation is different, though, if the sensor is installed at high altitude, say at a tank farm at 10,000-ft altitude. Here the average atmospheric pressure is 20.57 in. Hg, 69% of the average pressure at sea level. Without compensation the FPIR would indicate 35%LEL if tested with 50%LEL span gas, a large error, indeed. The same sort of error, in reverse, is encountered when the sensor is used in a deep mine. For this reason the FPIR can to be programmed for the altitude of its installation, adjustments from -6,000 ft to 15,000 ft are possible (See Chapter 5).

3.5 IR Processor Operation

The Delphian FPIR CHC sensor uses three light wavelengths to probe the gas in the atmosphere. Combustible hydrocarbons absorb the light to a greater or lesser degree depending on the gas concentration and the specific gas molecule structure. Using patented Determination Tables and algorithms stored in the IR Processor Module, the processor computes the best match between the observed light absorption and the stored absorption characteristics of a specific set of gases.

For the Determinator, from this calculation the gas type is determined and its concentration in % LEL is obtained. As a result the current signal output of the processor emits a current between 4.0 mA and 23.0 mA, whereby 4.0 mA signals 0 %LEL, and 20.0 mA signals 100 %LEL. CHC gas concentrations below 120 %LEL are signaled linearly. At CHC concentrations of 120 %LEL and beyond the signal is held at 23.2 mA indicating "Over-range".

For the Remediator the percent by volume of gas is obtained. The current signal output of the processor emits a current between 4.0 mA and 23 mA whereby 4 mA is equal to 0% of gas and 23mA is equal to 100% by volume of gas.

Note: The processor signal can be set to work with the analog Delphian controllers with their 1 to 5 mA input range. In the 1 to 5 mA mode, there is no differentiation between fails. They are all transmitted as a FAIL.

Note: If the processor is unable to determine which gas is being detected (either because there is a mixture of gases or the gas is not in the Determination Table), the processor will use its default tables to guess at the correct LEL. However, a gas type will not be displayed.

Note: Occasionally two gases may have such close signatures that the processor module can not tell them apart. For instance, Butane and Isopentane have virtually the same signature. If it is unlikely that one of these gases will be present, the processor module can be disabled for that gas, otherwise it will default to whichever of the two gases has the higher value. See Chapter 4 Installation for information on disabling a gas type.

Note: Each time a new sensor is connected to a processor it downloads from the sensor the latest gas determination table. As a result, new sensors always have the latest information. In addition, a sensor can be returned for upgrading if a new gas is added to a plant's list and that gas does not happen to be in the gas determination table for the sensors they have.

The processor performs health checks on an on-going basis. Among the items tested are the integrity of the light source, the electrical power supplied to the processor, the light loss due to contamination of the optical surfaces, noise at the optoelectronic front end, and so forth. As long as the processor can function usefully, albeit with increased error or uncertainty, the detected faults are only displayed on the local LED display of the processor and transmitted on the RS-422 / RS-485 serial data line. If the sensor fails, the signal current will decrease to below 3 mA as listed in Table 6. Table 7 lists all the informational, warning, and error codes displayed on the processor LED display.

The signal current is sent to the system control device via a 3-wire cable. This current must be terminated so that the signal source voltage remains at least 15 volts below the processor "+" power supply terminal when the signal current is at the maximum 23.2 mA. A 250-ohm resistor which is connected from the control device's signal input to ground is the standard form of

4-20 mA signal line termination. Adjustments in the control device should allow the conversion of the signal current from the processor into standard gas concentration values. These values can be displayed and used to activate alarms, when appropriate, by the control system.

3.6 Determination Table & Transfer Factors

For each CHC there is a specific minimum concentration above which an ignition source will cause an explosion or flame front propagation. This is called the Lower Explosive Limit (LEL) or Lower Flammable Limit (LFL) of that gas. The LEL differs for different hydrocarbon gases in air. The Delphian FPIR CHC sensor primarily measures the amount of CHC gas within the sample tube volume. With the intermediary of stored determination tables and patented analytical algorithms in the processor of the sensor, the sensor directly computes the gas concentration relative to the LEL and displays the result as %LEL. See gas graphs at the end of Chapter 2.

Unlike the situation with catalytic beads or conventional IR-based gas detectors, the Delphian FPIR CHC sensor does not require a list of transfer factors relative to methane. Instead the sensor internally compensates for the differences in sensitivity and gas/air mixture ratios before computing the LEL. In special cases where the target gas of an installation is not included in the list of gases recognized by the Sensor, an IR sensor with a custom gas determination table can be ordered from Delphian.

3.6.2 Function Check with Calibration Gas

The Delphian FPIR sensor compensates for the effects of temperature and humidity in the environment on combustible gases. Also, there is no physical change in the material associated with the gas measurement. For this reason there is no need to “calibrate” the Delphian FPIR CHC sensor on an ongoing schedule. As a precaution and to build confidence Delphian recommends that the customer ascertain full functionality of the system by checking the response to 50 %LEL methane (or ethylene or propylene) calibration gas, at least once, every 6 months. Higher concentrations are recommended for the Remediator 855 system. It would be

safer to check more frequently. Methane gas is preferable to other gases because it requires full functionality of all four detection channels for gas identification and concentration measurement.

NOTE: See Section 6 for required zero adjustments and how to test using span gas.

3.6.3 Operating The Sensor When Several Gases Can Be Present (see note)

The Delphian FPIR CHC sensor is especially well suited when monitoring an area where several different CHC gases may be present at different times. Suppose methane, ethane and butane were likely to be present separately at the sensor head. Each of the gases can be identified and the %LEL (% by volume for the Remediator) concentration displayed along with the gas type. In cases where a mixture of known gases in a fixed ratio must be detected Delphian can supply a custom calibration for the mixture.

NOTE: Turning ON/OFF Gases

The Determinator uses pre-programmed gas tables to identify combustible gases. The gases in the table can be turned on and off as described in Section 5 of this manual. It is recommended that only the gases to be detected should be turned on and other gases turned off. Only five gases can be turned on at any given time.

NOTE: The 855 Remediator typically has only one gas loaded into the sensor, therefore turning ON/OFF gases is not applicable.

3.6.4 Sensor Unable To Determine Gas

If the processor is unable to determine which gas is being detected (either because there is a mixture or the gas is not in the determination table, the processor will do its best to guess at the correct LEL, however, it will not display a gas type. In this case =000= will be displayed.

4. Installation

4.1 Wire Size Information

4.1.1 Wiring Between the Detector Head and the Control Device

Three electrical conductors are required between the control device (Sage sensor satellite, DC or analog Controller, or PLC) and the Detector Head. The conductors should be shielded. Two of these conductors are used to supply DC voltage to the processor assembly electronics. The third conductor is used to send a DC current signal from the IR Processor Module electronics to the control device. The AWG of the electrical conductors must be such that each conductor has a single line resistance of less than 10 ohms (the maximum loop resistance of the wire is, therefore, 20 ohms). With the electronics connected the maximum impedance between the processor connections (SIG) and (-) should be 250 ohms.

Table 2 gives cable lengths and various wire sizes.

CAUTION

- 1: Good design practices dictate using cable lengths conservatively shorter than the maximum length.
- 2: For the detector head use supply wires suitable for at least 7C above surrounding ambient. For the SLAM (relay) assembly, use supply wires suitable for at least 13C above surrounding ambient.

Note: The detector head wiring should be separate from AC or other high current DC wiring. To avoid ground potential problems which could result in (EMI) electromagnetic interference, there should be a common ground. The Flexirack earth ground is intended only to avoid shock and is not used by the system's circuitry.

			SAFETY FACTOR					
			None		25%		50%	
AWG	cross section mm	ohm/1000ft @ 159F	m	ft	m	ft	m	ft
20	0.52	11.9	240	800	180	600	120	400
19	0.66	9.5	340	1100	250	825	170	550
18	0.81	7.5	400	1300	300	975	200	650
17	1.03	6.0	520	1700	390	1275	260	850
16	1.32	4.7	640	2100	480	1575	320	1050
15	1.65	3.8	820	2700	620	2025	410	1350
14	2.08	3.0	1040	3400	780	2550	520	1700
13	2.63	2.4	1280	4200	960	3150	640	2100
12	3.32	1.9	1620	5300	1210	3975	810	2650

Table 2: Recommended Cable Length Between Control Device and Detector Head

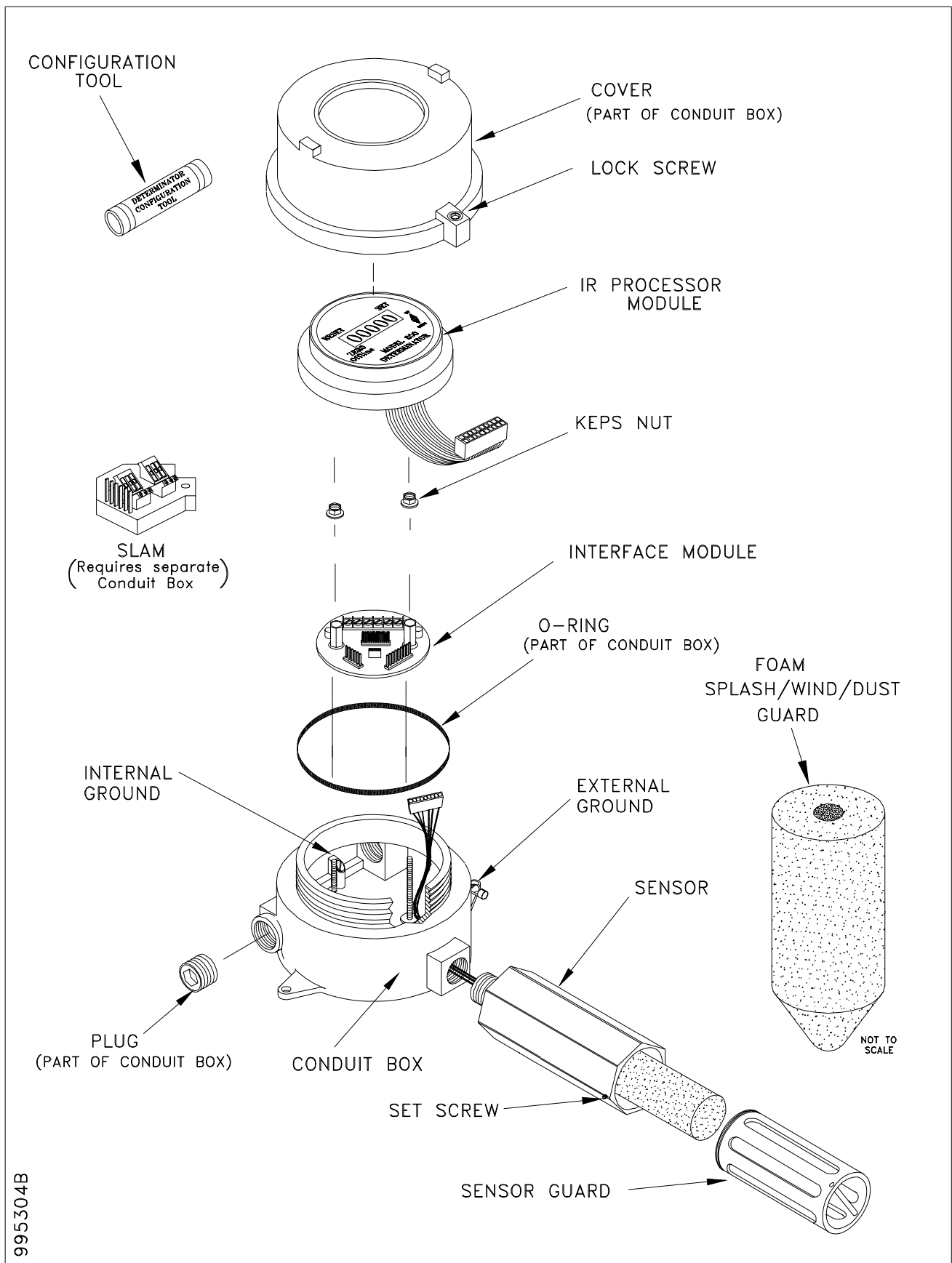

Figure 9: Typical FPIR Installation and Configuration (Drawing # 995304)

4.2 Installing the Processor, Interface and Sensor

The sensor is screwed into a 3/4-inch NPT threaded opening on the bottom of the three hub explosion proof conduit box. An explosion proof electrical conduit is screwed into the 3/4 inch NPT threaded openings on the sides of the conduit box, leaving the box suspended by the electrical conduit. An extension kit is available for locating the sensor remotely from the Processor. See Figure 9 for a typical installation and configuration.

CAUTION: IN ALL INSTALLATIONS THE CONDUIT BOX MUST BE INSTALLED SO THAT THE SENSOR IS FACING DOWN AS SHOWN IN Figure 3. IMPROPER SENSOR ORIENTATION WILL RESULT IN UNRELIABLE READINGS. See the end of the chapter for sensor location considerations.

Sensors and processors should be installed to comply with all local electrical codes. Delphian recommends using appropriate electrical conduit seals, breathers and drains to reduce water build up in the processor assembly conduit box. The sensor housing is designed to meet N.E.C., FM Approvals and CSA requirements for Class 1, Division I, Group C, and D environments. Be sure the conduit box is rated for the correct environment. **NOTE: A CERTIFIED ELECTRICAL CONDUIT SEAL SUCH AS THE CROUSE HINDS EYS2 OR EYD2 MUST BE USED WITHIN 18 INCHES OF THE DETECTOR HEAD ASSEMBLY.** (See Figure 11)

CAUTION: DO NOT OPERATE ELECTRONICS WITH GROUND WIRE DISCONNECTED. **NOTE: THIS IS A SAFETY GROUND FOR THE CONDUIT BOX.** A grounding assembly (grounding cup washer, washer and nut) is provided with each detector head conduit box (See Figure 9)

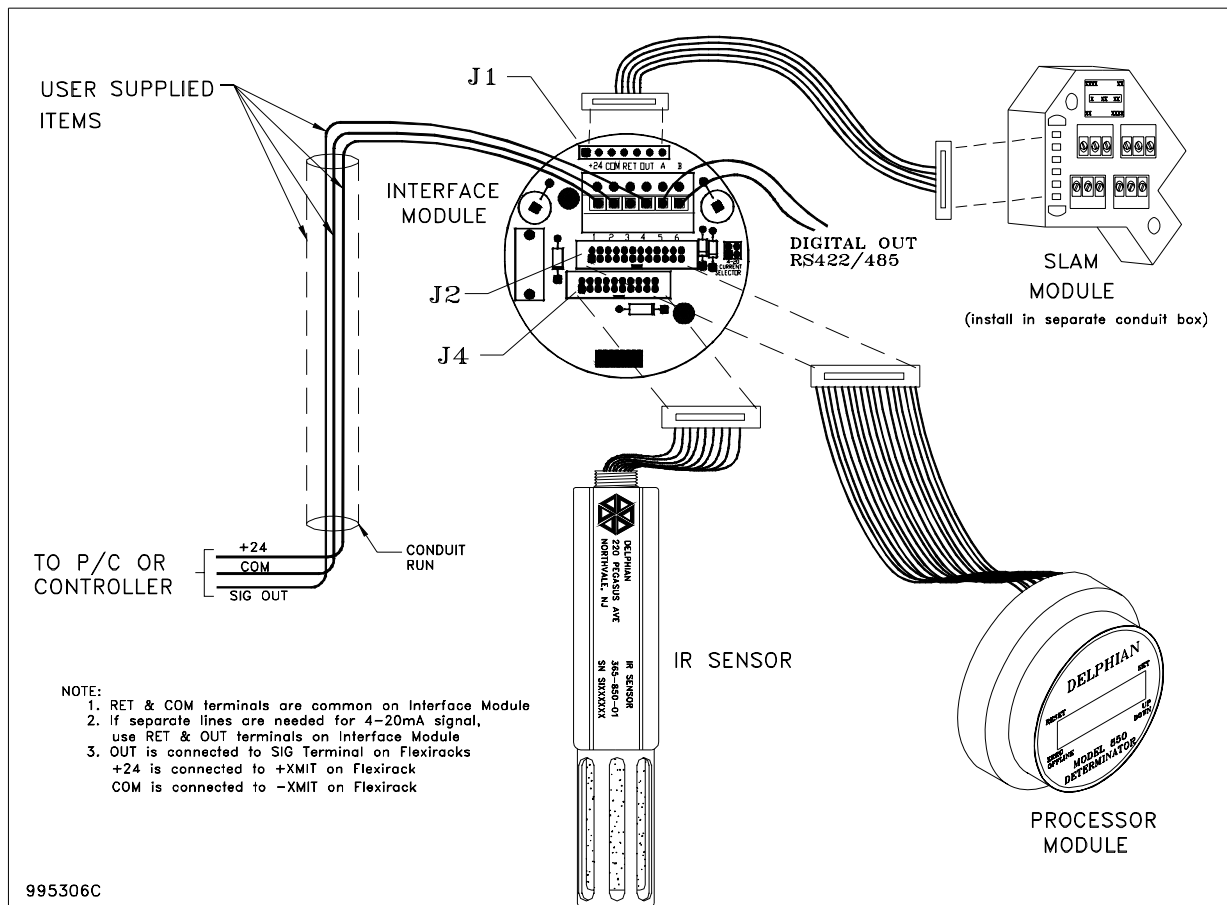

Figure 10: Installing the FPIR Sensor (Drawing # 995306)

995305C

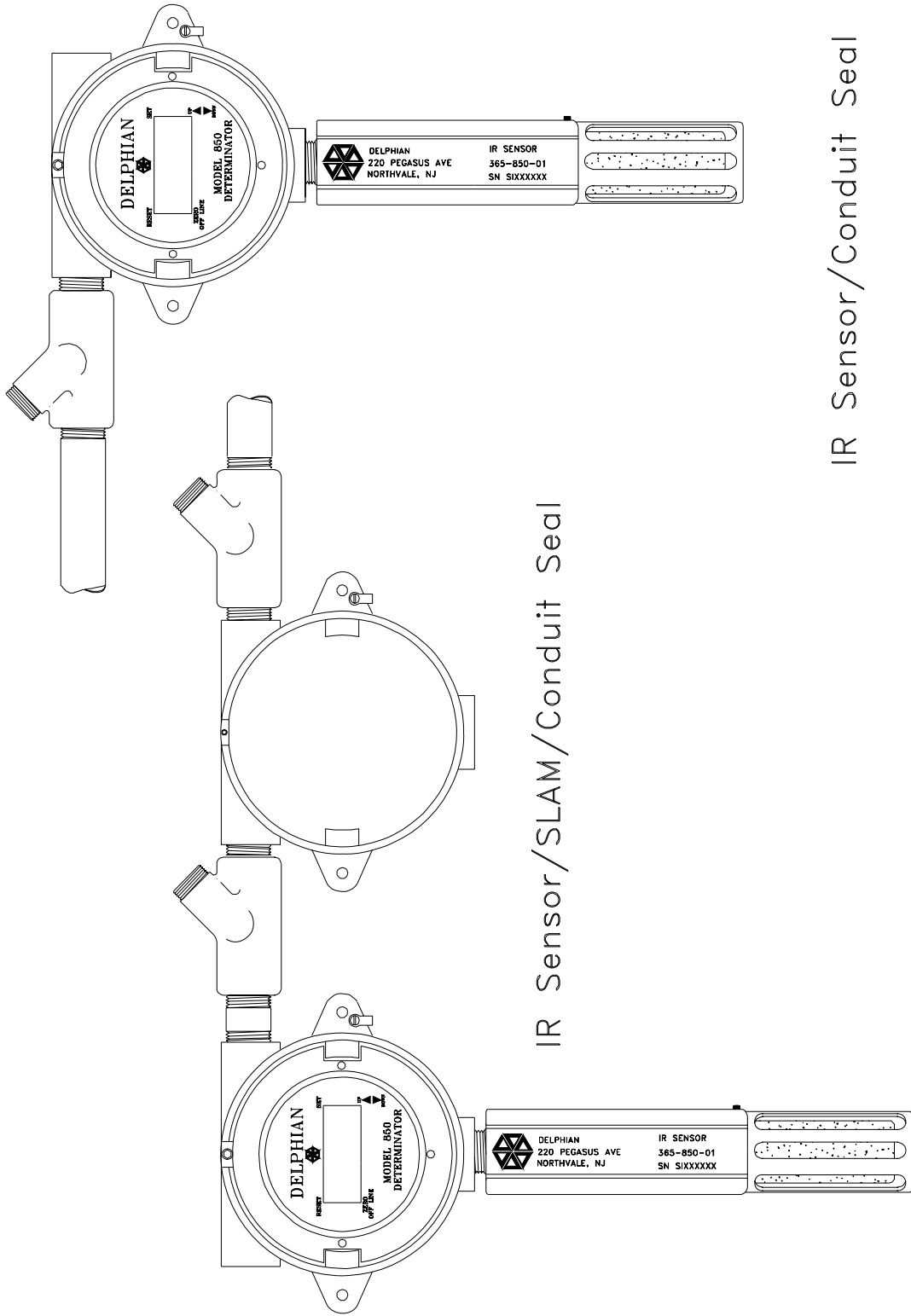

Figure 11: Electrical Conduit Seal (Drawing # 995305)

4.3 Installing the Sensor

1. ENSURE THAT THE AREA IS DECLASSIFIED.
2. Remove the conduit box cover. Ascertain that there are three conductors coming out of the conduit and that these conductors are connected to the proper terminals on the Interface Module inside the box. See Figure 10.
3. Tighten all threaded fittings securely with a wrench. Use a splash guard (available as an option) over the sensor if the area is prone to be affected by water, wind, or dust.
4. Insert the sensor connector through the 3/4 inch opening at the bottom of the conduit box. Plug the connector from the sensor into the mating receptacle located on the Interface Module secured to the bottom of the conduit box. Make sure that the connector is indexed properly before it is inserted into this receptacle.

The sensor should be installed so that normal cleanup operations will not expose the flame arrestor to water or other liquids. The Foam Splash Guard may help protect the sensor. NOTE: Make sure that enough room has been allowed to easily fit the Splash Guard or Delphian optics cleaning or calibration connection on the sensor during function checks. Sometimes it is necessary to put spacers between the processor conduit

box and the wall. (See Figure 12 Outline Drawing). If the sensor is to be mounted in a duct or if the temperature of the air exceeds the temperature of the sensor, the Reclamation Adaptor should be selected.

4.3.1 Sensor Maintenance

Delphian Corporation recommends that, before going to longer intervals between sensor operation checks, each FPIR sensor be checked at least every three months, until it is verified that the sensor is operating correctly. Maintenance procedures are given in a later Chapter.

Note: IN A NEW INSTALLATION, AFTER POWER HAS BEEN APPLIED FOR TWO HOURS, DELPHIAN RECOMMENDS THAT THE OPERATION OF EACH SENSOR BE CHECKED TO VERIFY THAT IT HAS BEEN PROPERLY INSTALLED AND IS WORKING CORRECTLY.

4.4 Installing the Interface Module

The Interface Module (Figure 10) is designed to allow easy plug in connection of the Sensor, the Processor and optional modules such as the SLAM. It also provides convenient wiring for power and communica-

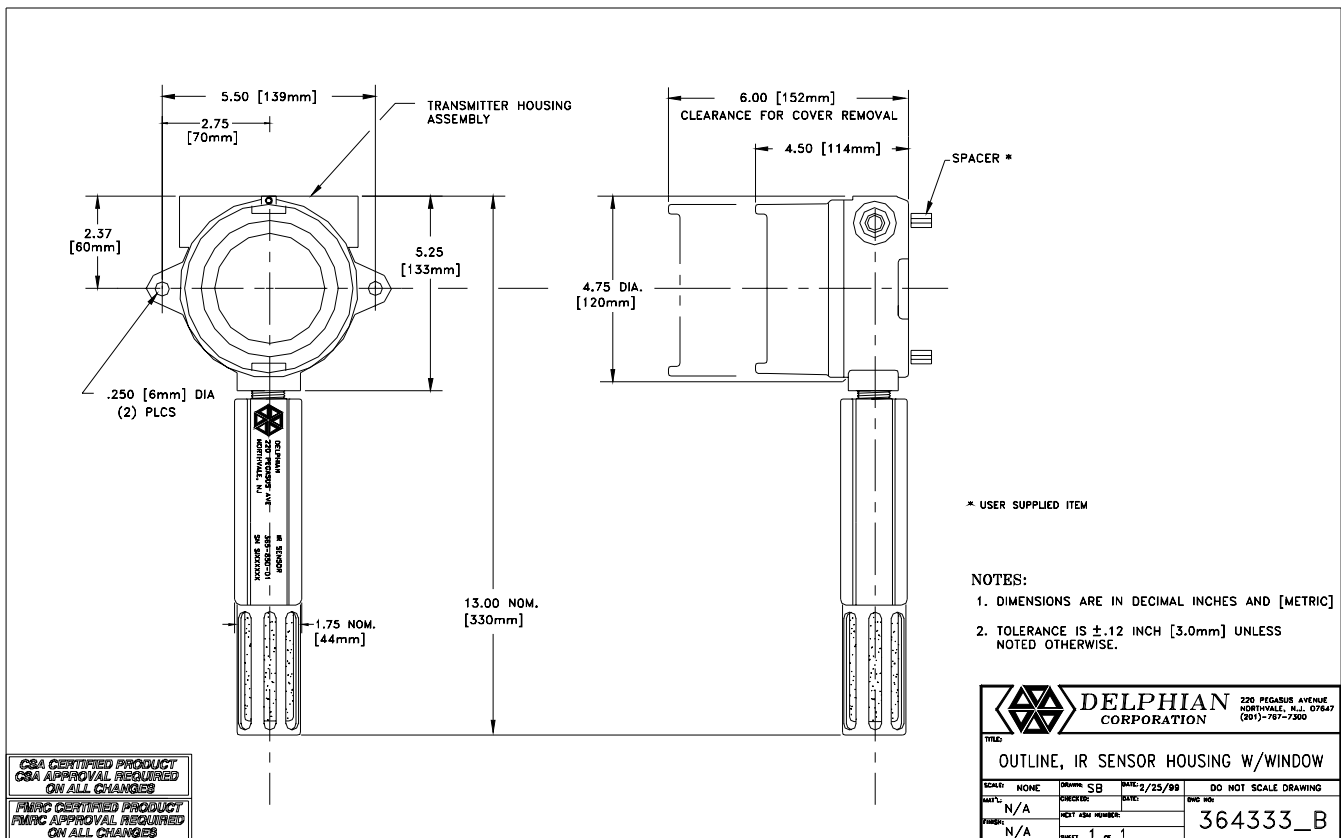

Figure 12: Outline of FPIR Sensor Housing with Window (Drawing # 364333)

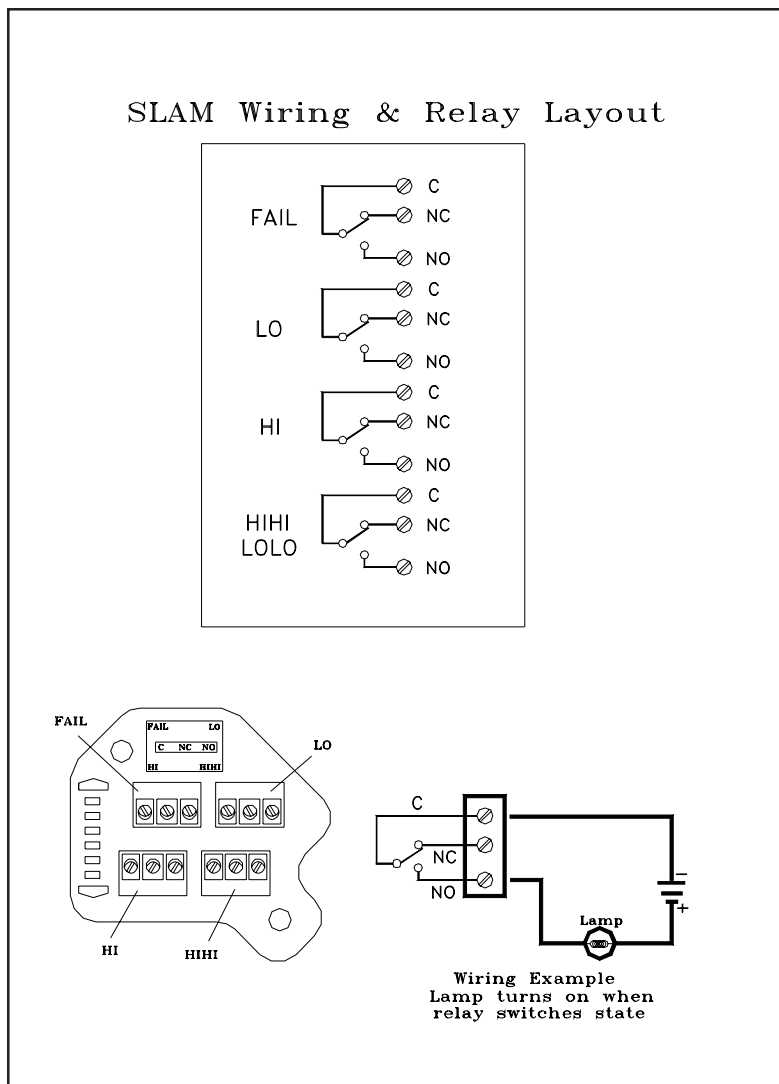

Figure 13: SLAM Wiring and Relay Layout (Drawing # 995196)

tions. It is normally installed in the Conduit Box at the factory. In the event it must be field installed, the Interface Module should be installed first, then the power and signal wires connected, lastly the sensor and the Processor Module connected.

Note: Unless a system is delivered with Delphian analog controllers the jumper on the Interface Module is set for 4-20 mA output.

Warning: ALWAYS REMOVE POWER FROM THE DETECTOR HEAD BEFORE REMOVING OR INSTALLING THE SENSOR OR OTHER MODULES. VOLTAGE CAN STILL BE PRESENT AT THE INTERFACE MODULE (+) TERMINAL IF USING THE SENSOR SATELLITE OR FLEXIRACK. Although the sensor and processor can normally be hot plugged and unplugged, they could cause an explosion if power is applied incorrectly or if the area is not declassified. It is good engineering practice to disconnect the power until all of the modules are in place and the conduit box cover is securely attached.

4.5 Installing the Processor Module

The Processor Module (Figures 9 & 10) is an epoxy encapsulated digital module which controls the operation of the sensor and the SLAM as well as providing a continuous digital reading of the gas being measured. The Processor plugs directly into the Interface Module. It is the last component to be installed before the cover of the conduit box is reconnected.

4.6 Installing the Optional SLAM Relay Module

The SLAM provides four form C, (SPDT) local relays that can be operated by the Detector Head. Each relay is a dry contact rated for 2 Amps at 24 Volts DC. The maximum wiring size is 14 AWG. Each relay can be wired to be normally open (NO) or normally closed (NC). The Processor Module controls all other relay functions (see section 5.5 for defaults and changing the operation of the relays).

The SLAM Module connects to the Interface Module via a seven-pin, five-wire cable with two female connectors on each end. The connectors are keyed and labeled for each module. If the connectors are reversed, the SLAM will not operate.

NOTE: The SLAM (relay assembly) requires its own conduit box, rather than in the conduit box with the Processor. If the SLAM relays are connected to a 120 Volt AC current, this separation will prevent the AC currents (EMI) from affecting the operation of the Processor. A certified explosion proof seal must be installed between the detector head and the SLAM assembly.

When ordering a SLAM, order the SLAM Extension Kit. See section 9 for Part Numbers.

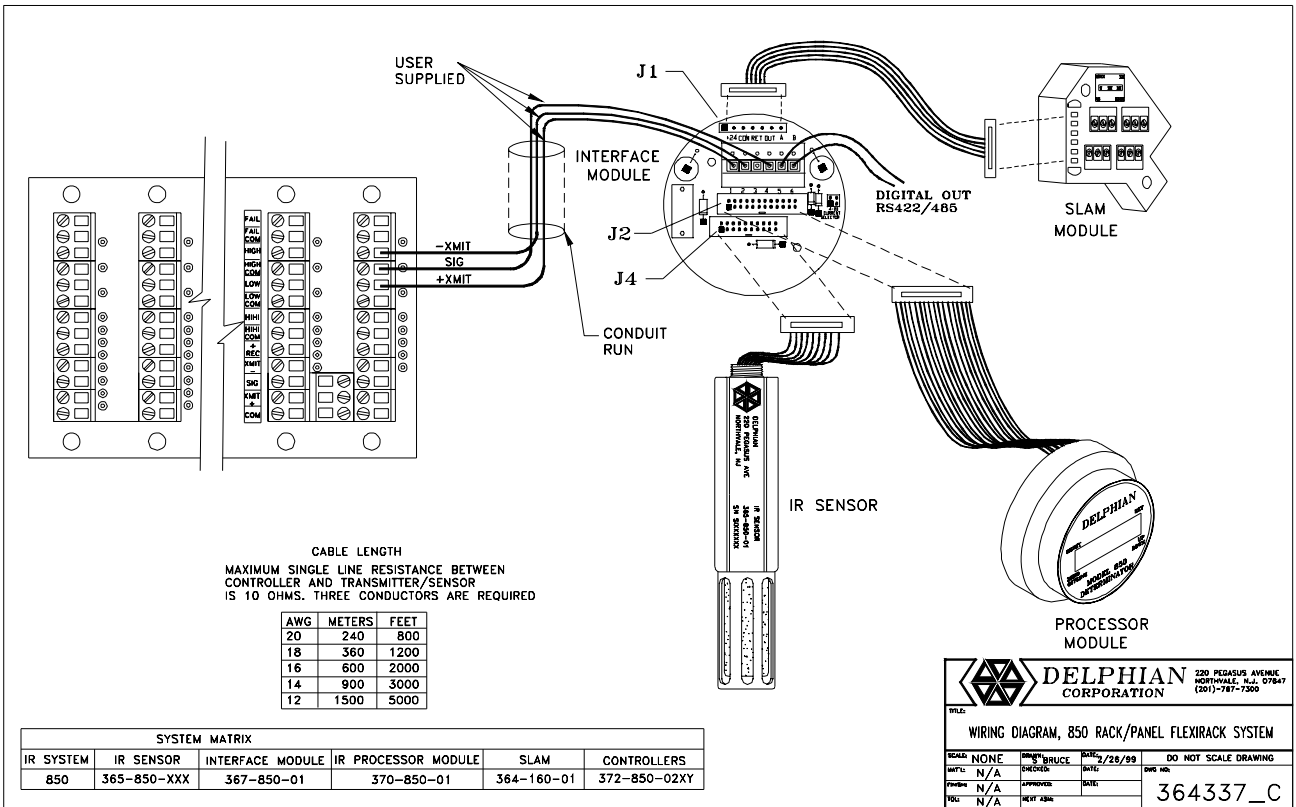
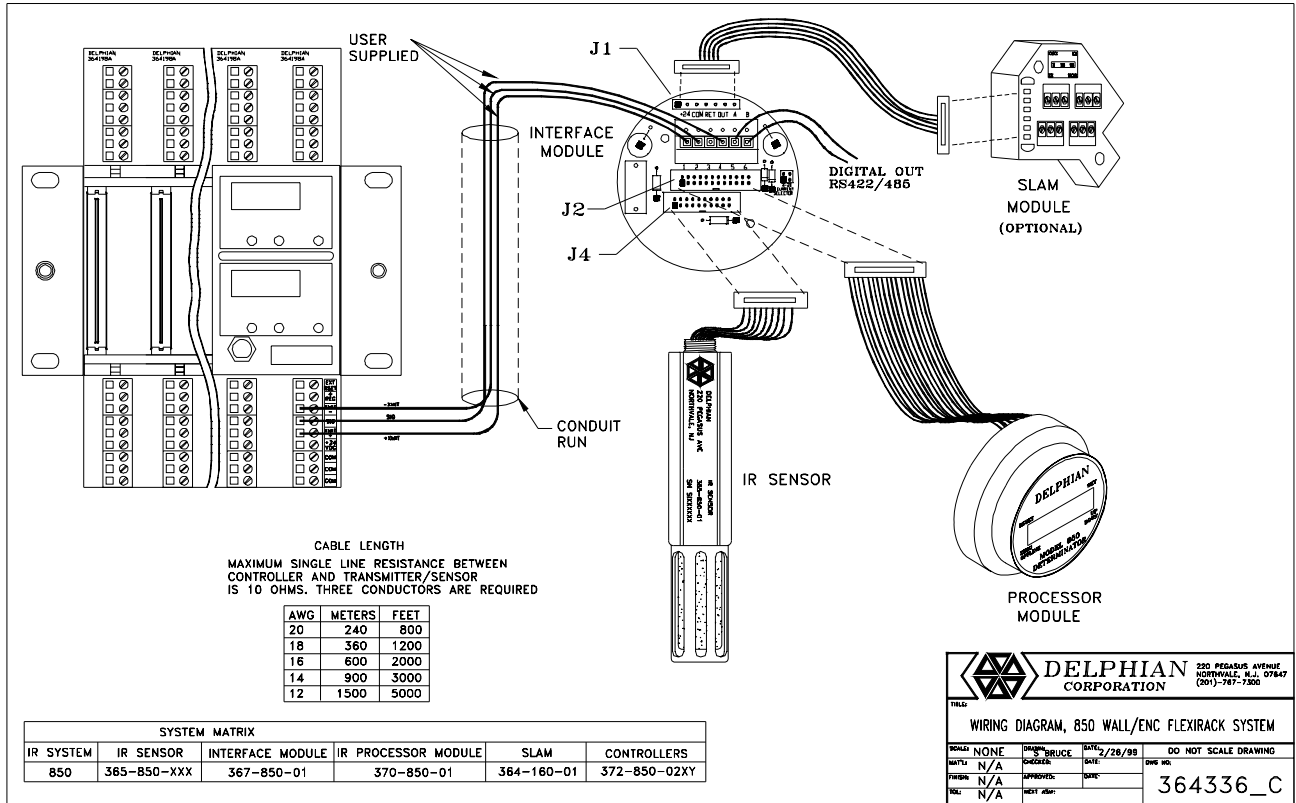

Figure 14: Wiring Diagrams for the Flexirack Systems (Drawings 995336 & 995337)

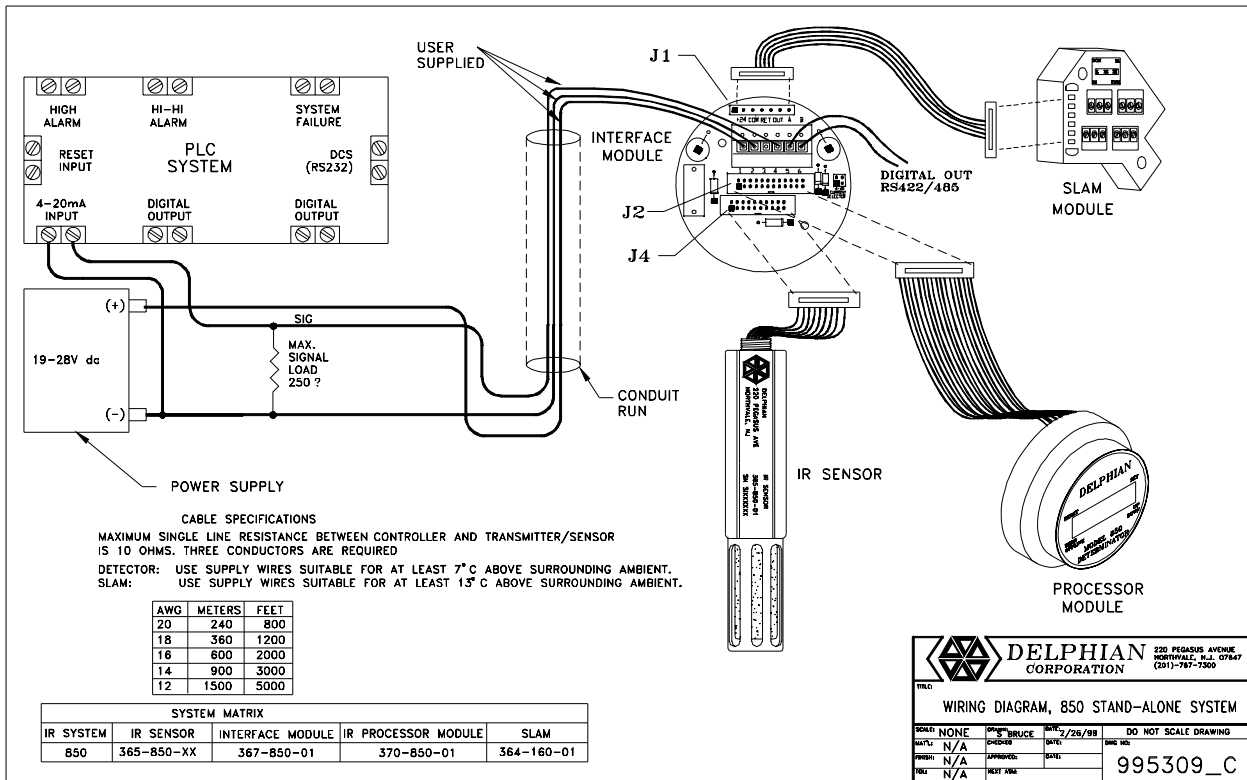

Figure 15: Wiring Diagram, FPIR StandAlone System (Drawing # 995309)

4.7 Preparing the System for Initial Use

A shop test of each detector head is recommended before field installation and use. Systems have often been shipped from location to location several times and are often kept in storage for a considerable time. As a result they could be damaged.

4.8 Suggested Sensor Location Considerations

4.8.1 Introduction

This information is included for informational purposes only and is intended to be used only as a guide to some of the important considerations. It is not an exhaustive review of all considerations, nor is it a substitute for common sense and good engineering judgment. Because there are so many variables that must be taken into account, there are no hard and fast rules.

CAUTION: The Delphian FPIR CHC sensor is a point monitor, which means that it can monitor gas only at the

single point where it is installed. It does not cover an area. If gas from a leak does not reach a sensor, the leak will not be detected. The selection of the number of sensors to install and the site for each sensor are two of the most critical factors to be considered for overall system effectiveness. PLACING THE SENSOR IN THE WRONG LOCATION WILL DEFEAT THE PURPOSE FOR WHICH IT IS INTENDED. One of the most important concepts to keep in mind is that the sensor should be placed between the potential leak and the ignition source for combustible gases. For complicated installations, it is good practice to prepare drawings showing all potential leak sites. The locations should be graded in terms of their potential for harm.

4.8.2 Sensor Site Selection Basics

Vapor Density of Gases to Be Monitored.

Sensors should be located near the ground for gases or vapors which are heavier than air. You should consider not installing them closer than 18 inches above the ground so they will not be as likely to collect mud and water. To detect heavy gases some companies do not allow sensors to be installed higher than 36 inches. In

enclosed spaces the sensors should be located near the ceiling, roof, or exit fan to detect lighter than air gases. You can not rely, however, on heavier or lighter gases always behaving in a predictable manner. Even inside, air currents can create anomalies. Be especially aware of areas that could become potential gas pockets.

Air Currents

Locate the sensor where prevailing air currents would be likely to contain the maximum concentration of the gas being monitored. Consider the possibility of changes in wind direction at different times of the day or during different seasons. Your local weather information center should have data on the direction and velocity of prevailing winds during the yearly cycle.

Dispersion of Gas/Vapor

Generally sensors should be located close to any potential leak source. Liquids of low volatility, in particular, may require the location of the sensor in the immediate area of the vapor source. Liquids with high flash points or slow rates of dispersion take a long time to produce readings if the sensors are any distance from the spill or leak.

Temperature Limitations

All sensors and electronics have ambient temperature limitations. The installation of the sensor must be within the operating range of both. If the gas temperature is too high for the sensor, a gas reclamation adaptor is available to draw air samples to the sensor. By connecting metal coils to the inlet side of this adaptor, the gas can be cooled down. If any preconditioning system is to be used, make sure that the vapors will not condense in the piping.

Vibration

Vibration can be damaging to the sensor and may void the warranty. Anchor the sensor to a wall or firm base rather than to a vibration source such as a motor housing. A length of flexible conduit used between the sensor and the pipe conduit can also give vibration protection.

Moisture Protection

Sensors should be installed where they are protected from immersion or direct contact with water, i.e. where the floor is hosed down, steam cleaning is done, or where the water level/table rises in a drainage ditch. In the case of water contact, steam or hosing, or blowing rain, the foam splashguard will help protect the sensor.

Accessibility

Because it is necessary to check sensors periodically, they should be installed in a location permitting reasonable access and with sufficient room to easily connect the calibration adaptor.

EMI/RFI

Presence of EMI may cause incorrect operation

Sensor Orientation

The Delphian FPIR CHC sensor must be installed in a vertical orientation, with the flame arrestor pointing at the floor. This will insure optimal heat assisted air diffusion into the sensing area. If the sensor is not mounted this way, the air diffusion into and out of the sensor probe volume will be impeded and the sensor may not respond properly.

Conduit, Seals, And Drain Plugs

It is mandatory that good conduit installation practices be observed. To comply with the requirements for equipment installed in Class I, Division 1 areas, an EYS seal or equivalent is required within a specified distance of a junction box. Once the wiring has been pulled, the seals are potted. This prevents a flame front from traveling down the conduit when the cover is removed from the conduit box.

Perimeter Monitoring

To monitor an area, you should consider placing the sensors no further than 50 feet from the leak sources and placing the sensors within 50 feet from each other. Some companies require sensor spacing to be between 30-40 feet.

To monitor an outside leak location of a heavier-than-air gas, 4 sensors are a minimum. Each sensor being placed at ninety degrees from the other as viewed from the leak source. Wind at 45 degrees from a sensor direction could still mean that no sensor would register the leak. To have good assurance, at least 8 sensors would be required. Consider placing them no more than 5-10 feet from the leak source.

Dust Protection

Foam splash/wind/dust guards should be used if sensors are mounted in dirty or dusty environments.

Obstructions

Even small structures, such as piping and equipment, between a potential leak source and the proposed sensor location can change the normal flow of air. All obstructions should be evaluated carefully.

Interior

Where coverage of an entire area is desired, pay particular attention to grade, floor or operating levels as well as to airflow from heating/ventilation systems. Pay attention not only to possible leak sites but to all penetrations and other points of entry where gas can be introduced into a closed area. Some companies have designated 400 square feet as the maximum area to be covered by one sensor. This number may not be appropriate for you.

For installations where coverage of specific equipment is desired, consider placing sensors no closer than 12 inches nor more than 5 feet away from the suspected leak source. Sensitivity of the sensor can be controlled, to a degree, by moving the head closer to the source for more sensitivity. A sensor between two vessels that are close together can often serve to monitor both.

For locations in fresh air ducts or in or near exhaust systems, possible areas of concern are high or variable airflow and high levels of humidity or excessive temperature.

Codes

Local, state and national codes and regulations should be checked before installation.

Other Exposures

Besides protecting workers in an environment, consideration should be given to other areas which may need protection, such as roads, housing, adjacent plants, public buildings, areas of community activities, etc. In addition, you may wish to consider protection from hazards that might be caused by adjacent plants.

5. Configuring and Using The FPIR Detector Head

5.1 StandAlone Description

The Delphian FPIR Detector Head is a stand-alone gas detector that provides a signal linearly proportional to the combustible gas concentration at the sensor. This signal and any alarms are displayed at the sensor. The optional relay module, SLAM, provides 3 gas alarm relays and one fault relay at the detector head. The processor produces a standard current signal, it can be easily connected to any data logging (PLC) or control system. The current signal is either 4-20 mA, or 1-5 mA for 0 - 100 %LEL (or full scale) or 0-100% by volume for a 855 Remediator system. In addition, the processor provides a digital RS-422 / RS-485 signal.

5.2 StandAlone Components

5.2.1 Determinator Components

The Delphian Determinator FPIR CHC (aluminum body) standalone [pn 364-850-01] consists of:

Sensor - aluminum body [pn 365-850-01]

Processor [pn 370-850-XXX]

Interface [pn 367-850-01]

Explosion Proof Housing [pn 361-868-02]

5.2.2 Remediator Components

The Delphian Remediator FPIR CHC (aluminum body) standalone [pn 364-855-01] consists of:

Sensor - aluminum body [pn 365-855-01]

Processor [pn 370-855-XXX]

Interface [pn 367-850-01]

Explosion Proof Housing [pn 361-868-02]

5.3 StandAlone Operation

The Delphian FPIR CHC Sensor / IR Processor operates in such a way that changes in gas concentration at the sensor are (1) shown on the local five digit LED display; and (2) cause variations in the signal current output from the processor. This current varies nominally from 4 to 20 mA (or 1 to 5 mA) depending on the gas concentration to which the sensor is exposed. The signal current is sent to a receiver such as a PLC via a 3-wire cable. This current must be terminated so that the signal remains at least 15 volts below the processor "+" terminal when the signal is at the maximum 20 mA. 250 ohms is the maximum admissible input resistance

value for a PLC input. Adjustments in the control system should perform the conversion of the signal current from the standalone detector head into standard gas concentration values. These values can be displayed and used to activate alarms, when appropriate, by the PLC.

The Delphian FPIR Detector Head is designed so that if it detects a component failure, the signal current drops below 4.0 mA allowing such a failure to be detected by the system controller. A list of error codes transmitted on the signal line or displayed on the local five-digit LED display can be found in Section 7.

5.4 Initial System Start-up

DETECTOR HEAD: perform the following when applicable:

[] Ascertain that all electrical connections are properly tightened.

[] Verify that all explosion-proof enclosures are provided with the correct number of proper bolts/fasteners and all required conduit/cable seal fittings.

[] Verify that the ground wire has been correctly fastened at the Power Supply.

[] Verify that bolts/fasteners are tightened securely according to specifications and that seal fittings are properly poured.

[] Apply power to the detector head and verify that all indicators operate properly.

[] Allow the sensor to warm up for at least two hours and check operation in accordance with this Manual.

[] If the sensor is to be used at an elevation greater than 500 ft above or below sea level, the correct elevation of the detector head should be adjusted as described in at the end of this chapter.

[] With the sensor in an atmosphere free of any gas to which it responds, verify proper operation of all alarm set points by applying methane test gas. THIS SHOULD TRIGGER ALL OF THE GAS ALARMS SET BELOW THE HIGHEST ALARM LEVELS. If the test results are not within 10 percent of the applied gas concentration zero adjust.

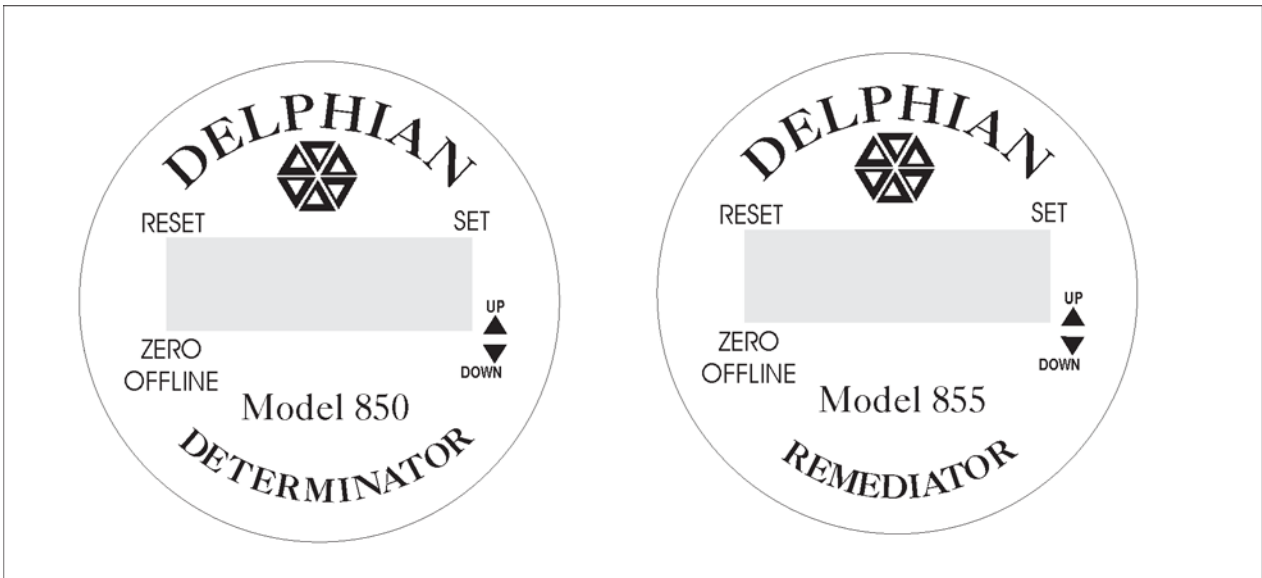

Figure 16: Processor Face

5.5 Setting Gas Alarms

1. Alarm Setup Procedure

The Delphian FPIR CHC sensor provides three gas alarms and one fail alarm that can be customized by the end user in the field. These alarms are not transmitted on the 4-20 mA line, but are displayed at the sensor. If a SLAM Module is attached, they will activate the SLAM's relays. Each of the 4 relays on the SLAM can be configured to be normally open or normally closed, see section 4.6 for details on installing the SLAM. Table 4 summarizes the all the default settings.

* **Preprogrammed** means that the Delphian CHC Sensor Head comes with these values and settings already programmed. To meet code requirements, the settings for FAIL can not be changed.

Note: The Detector Head is preprogrammed for operation at sea level. To change this setting see section 5.7. Unless a system is delivered with Delphian analog controllers the jumper on the Interface Module is set for 4-20 mA output.

2. Programming (Configuring) Sequence

The detector head's functions can be changed without removing the cover of the explosion proof enclosure (and without declassifying the area) by using the Configuration Tool (magnetic wand) to touch the "Programming Points" on the Processor through the enclosure's window. To avoid accidental changes, some functions require the magnetic wand to be held over a programming point for several seconds. The programming points are shown in Figure 16.

5.6 Programming

5.6.1 Hold Delays

To avoid accidents, all programming points, except UP and DOWN, have hold times (delays) which require the user to hold the calibrator over the programming point for 1-4 seconds. (See figure 16).

- A. RESET has a 1 second hold time
- B. SET has a 1 second hold time
- C. OFF / ON-LINE has a 1 second hold time
- D. ZERO has a 4 second hold time

5.6.2 Calibrator Colors

The BLUE end of the calibrator is used for most commands. The RED end is only used over:

- A. Down Arrow
- B. ZERO

5.6.3. To program the detector

First take the detector OFFLINE by applying the blue end of the calibrator for 1 second. The display shows OFF alternating with a reading for the gas concentration. (This reading is not being transmitted) Initiate programming by applying the blue end of calibrator for 1 second on SET. The display shows the first gas alarm which can be set, 'Lo' for the low alarm.

5.6.4 Moving between menu items

By touching the calibrator to SET the menu moves from one item to another, ie: Low Alarm to High Alarm, High Alarm to HiHi Alarm.

5.6.5 Selections within each menu item

Within in each menu item, selections are controlled by the UP/DOWN arrows.

FLOW CHART OF ALARM SETPOINT PROGRAMMING

Note: The underscore [] signifies an empty or off display position. The underscore is not displayed.
Display is cycled if more than one piece of information is given.

TOUCH				DESCRIPTION	DISPLAY
OFFLINE				Toggles system off-line & turns relays (SLAM) off	XX### [LEL w/alarm]
	SET			Enters the setup programming & advances to LO alarm setpoint	Lo_On
		↑↓		Toggles alarm ON/OFF	Lo/OF/Lo/nL
			SET	Advances to % LEL or jumps to HI alarm settings if Lo alarm is off	Lo_20
			↑↓	Increment/decrement by 1% each time magnet touches ↑or↓ point (hold for quick ramp)	Lo-8 to Lo-60
			SET	Advances to Latching/ Non-Latching relays	Lo_nL
			↑↓	Toggles Latching/Non-Latching	Lo_LA/Lo_nL
			SET	Advances to Energized/De-Energized relays	Lo_E
			↑↓	Toggles Energized/De-Energized relays	Lo_dE/Lo_ _E
	SET			Advances to HI alarm setpoint	HI_On
		↑↓		Toggles alarm ON/OFF	HI_OF/HI_On
			SET	Advances to %LEL or jumps to HIHI alarm settings if HI alarm is off	HI_40
			↑↓	Increment/decrement by 1% each time magnet touches ↑or↓ point	HI-8 to HI-120
			SET	Advances to Latching/ Non-Latching relays	HI_LA
			↑↓	Toggles Latching/Non-Latching	HI_nL/HI_LA
			SET	Advances to Energized/De-Energized relays	HI_E
			↑↓	Toggles Energized/De-Energized relays	HI_dE/HI_ _E
	SET			Advances to HIHI alarm setpoint	HH_On
		↑↓		Toggles alarm ON/OFF	HH_LA/HH_nL
			SET	Advances to %LEL or jumps toSEQUENCE COMPLETED if HIHI alarm is off	HH_60
			↑↓	Increment/decrement by 1% each time magnet touches ↑or↓ point	HH-8 to HH-999
			SET	Advances to Latching/ Non-Latching relays	HH_nL
			↑↓	Toggles Latching/Non-Latching	HH_LA/HH_nL
			SET	Advances to Energized/De-Energized relays	HH_E
			↑↓	Toggles Energized/De-Energized relays	HH_dE/HH_ _E
	SET			Advances to SEQUENCE COMPLETED	donE (blinking)
SET				Confirms programming	donE
ONLINE				Returns system to active	On for 4 sec, then XX###

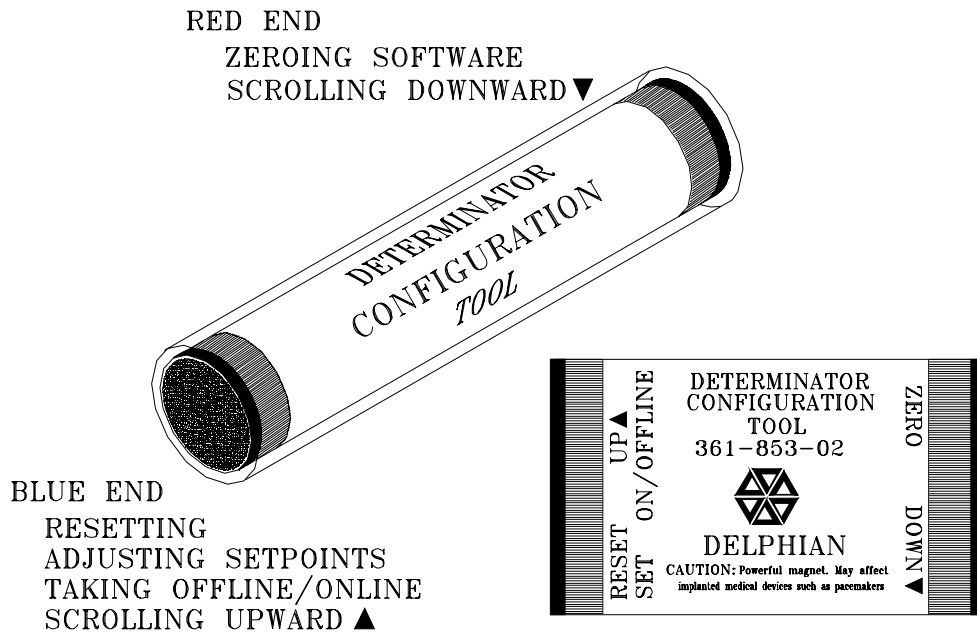

Figure 17: Configuration Tool (Calibrator) (Drawing # 995311)

Notes to Flow Chart for Alarm Setpoint Programming of the Determinator (applies to Determinator 850 only) (see Table 3 Opposite)

1. XX is blank for LEL below low alarm, Lo for the low alarm range, HI for the high alarm range and HH for levels greater or equal to the HiHi alarm level. ### is 8 to 999.
2. If an alarm is turned off, the relay setting adjustment steps are skipped. Neither the % LEL setting, nor the relay latching, nor the relay energizing can be programmed. The programming sequence automatically advances to the next higher level of alarm, or to the SEQUENCE COMPLETED step.
3. The LO alarm can be set within the range from 8% and 60%. The high limit is based on approval agency standards.
4. The HI alarm level can be set to any level equal to or higher than the LO alarm level. If the LO alarm has been turned off HI can be set to any level between 8% and 120%. **Note that you can override the approval agency requirement by turning off the LO alarm and setting the HI alarm to a level higher than 60% LEL. It is the user's responsibility to insure that the controller/PLC attached to the CHC head triggers an alarm at or below 60% LEL.**
5. When programming has been completed there is a 15 second delay before the unit returns to the original OFFLINE status. During this time the elevation/gas sub-menu can be initiated by holding the red end of the calibrator over ZERO for 4 seconds. See Section 5.8.

NOTE: Alarm devices, output contacts or signal outputs (if provided as part of stationary instruments or continuous-duty portable instruments and intended to indicate a potentially flammable gas concentration) shall be of a latching-type requiring a deliberate manual action to reset. If two or more set or alarm positions are provided, the lower may be non-latching.

FPIR Programmable Alarms Preprogrammed Defaults							
Alarm	On- /Off	Latching/ Non-Latching	Energized/ De-Energized	Determinator % LEL Range		Remediator % by Volume	
				RANGE	PRESET	RANGE	PRESET
FAIL	On	NL	E				
Lo	On	NL	DE	8% to 60%	20%	0.4 - 3.0% by volume	1%
HI	On	L	DE	LO to 120%	40%	LO to 98% by volume	2%
HIHI	On	NL	DE	HI to 120%	60%	HI to 99% by volume	3%

Table 4: Programmable Alarms

5.6.6 Saving the changes

At the end of the menu, the display shows a *flashing* “donE” indicating that the sequence is complete. At this point the changes can be written to nonvolatile memory by touching SET a second time. A dashed line “ - - - ” will be shown as the information is written to memory. A *steady* “donE” is displayed when the information has been written successfully.

5.6.7 Resetting Without Saving Changes

To cancel changes and abort the programming touch the calibrator to RESET at any time before the final SET command saves the changes to nonvolatile memory.

5.6.8 Automatic Reset Without Saving Changes

If, during the programming sequence, no programming point has been “touched for ten (10 minutes), it will automatically reset (without saving any changes), but will remain OFFLINE until put Online by the user.

Note: OFFLINE toggles between Online and Offline.

5.6.9 Returning to Online Status

Once the programming sequence is complete, either because changes have been saved or because it has been reset without changes, the display shows “OFF”. To turn the unit back on line, hold the blue end of the calibrator on OFFLINE. The display will momentarily show “On” and then the gas reading.

5.7 Elevation Set-up

If infrared-based gas sensors like the Delphian FPIR CHC sensor are used at elevations 500 ft [200 m], or more, above or below sea level the sensitivity needs to

be adapted to the atmospheric pressure, as explained in more detail in Section 3.4.4. The following procedure contains two sections: In the first section the units of measurement are selected, either engineering/English units [ft] or SI units [m]. In the second section the elevation can be set for the location of the sensor in increments of 500 ft, or 200 m. Delphian FPIR sensors are factory preset to engineering units and sea level elevation.

5.8 Programming the Elevation

After programming alarm levels, the display shows a *steady* “donE” hold the red end of the calibrator over ZERO for 4 seconds. When the sub-menu is entered the display will show either “Eng” for English engineering units or SI for International units. Using the blue end of the calibrator scroll up or down to reach the required level.

Note: The user has 11 seconds to initiate the sub-menu command after the *steady* “donE” is displayed. During this time the system cannot be put back On-Line. See Table 5.

5.9 Choosing Gases to Monitor

Specially developed determination tables are used to look up the footprint of different gases. Because there are three gas determination channels, the footprint of some gases are so close to others that significant percentages of one of the gases must be present before there is differentiation between them. For this reason, it is recommended that gases are turned off if they are not normally present in the target area. A maximum of five gases at a time can be turned on. See Table 5.

5.10 Programming Gases

After elevation has been set, the gas menu can be reached by applying the blue end of the calibrator to SET.

Gases are identified by a three digit number. For instance, 001 is methane. If the gas is turned on the display will show 001 = 1. If the gas is turned off the display will show 001 = 0.

To turn a gas on or off apply the blue end of the calibrator to the up/down arrows. Move to the next gas by applying the blue end of the calibrator to SET.

After scrolling through all of the gases available in the in determination table, the display will show a *blinking* “donE”. At this point either:

- save the changes to the gas table by apply the blue end of the calibrator to SET
- or
- abandon the changes by applying the blue end of the calibrator to RESET.

If more than five gases have been turned on, a prompt to re-select the gases will be given.

5.11 Monitoring Sensor Health

The Delphian FPIR Detector Head features a rich complement of sensor health monitoring features, some of which are capable of advanced warning of impending failure. The list of items checked continuously comprise:

- Filament integrity
- Light emitted by filament
- Detector integrity
- Excessive optical path attenuation
- Optical path obstruction
- Heater functionality
- Microprocessor functionality
- Electrical supply voltage

The local display at the sensor displays the detected warnings and failures, as does the serial digital output signal. Failures that prevent the sensor from measuring CHC concentration are also transmitted on the 4 – 20 mA signal line, Signal Current and Error Codes. Nonfatal errors are not transmitted on the 4-20 mA line.

TOUCH		Description	Display
ZERO (Red)		Enters the elevation programming after 4 second dwell	Eng_ or SI
	↑↓	Toggles between SI units and engineering units	Eng_
	SET	Advances to elevation setting	E_000
	↑↓	Increment/decrement by 500 ft /200m each time magnet touches ↑ or ↓ (min -6000 ft/-1800m, max=15000 ft/4600 m)	E-### (below sea level)
	SET	Advances to SEQUENCE COMPLETED	donE (Blinking)
SET		Confirms programming	--- doneE
SET		Initiates gas menu	001 = 1 or 0
RESET		Reset skips gas menu	OFF

Table 5: Flowchart for Altitude and Sense Gas Programming

5.12 Sensor Display

(see list of messages and their meanings in Section 7)

1. When the sensor is operating normally, the display will show "0"

2. When gas is detected the display will show: "###": the amount of gas detected as a percentage of LEL

alternating with gas mount will be the gas identification display. GAS, =###=, if the gas is identified ### will be the gas number. For instance, methane is "001" If the gas cannot be identified the gas number will show as "000."

P/N 364-335-01 REV E

IR Determinator Recognized Gases List

Gas or Vapor	I.D.	Gas or Vapor	I.D.
ACETIC ACID	040	GASOLINE	080
ACETONE	009	HEPTANE	013
BENZENE	036	HEXANE	015
BUTADIENE	010	ISO-BUTANE	011
BUTANE	012	ISO-PENTANE	020
BUTANOL	021	ISOPROPANOL	008
BUTENE	042	METHANE	001
BUTYL ACRYLATE	043	METHANOL	003
BUTYRALDEHYDE	044	METHYL ACRYLATE	052
CYCLOHEXANE	019	METHYL ISO BUTYL KETONE	068
CYCLOHEXANONE	045	METHYL ETHYL KETONE	054
DICHLOROPROPANE	046	METHYL METHACRYLATE	056
DI-ETHYL ETHER	047	PENTANE	037
DI-ISOPROPYL ETHER	069	PROPANE	034
DI-METHYL ETHER	024	PROPYL ALCOHOL	022
ETHANE	006	PROPYLENE	026
ETHANOL	007	PROPYLENE OXIDE	027
ETHYLAMINE	039	TERT BUTYLAMINE	062
ETHYLENE	004	TETRAHYDROFURAN	063
ETHYL ACETATE	051	TOLUENE	064
ETHYL BENZENE	070	XYLENE	067
ETHYLENE OXIDE	002		

Table 6: Determination Table for IR Detector (364-335-01 Rev E)
(regularly updated on internet: www.delphian.com/determinator.htm)

6. Maintenance & System Checks

6.1 Routine Maintenance

The Delphian FPIR CHC sensor is a low maintenance instrument. It requires only periodic zero point adjustments. In addition operational checks, including a Span Gas Function Test, should be performed on a scheduled basis.

Note: The frequency of adjustments and operational checks depends upon the application and experience of the customer with the detector.

Note: Only qualified personnel trained in the operation, maintenance, and repair of infrared gas detection instruments should undertake maintenance procedures. “Qualified” implies not only the ability and training to perform recommended procedures, but also knowledge and understanding of the requirements of any applicable regulatory authority.

6.1.1 Visual Checks

1. Assure that the Delphian FPIR CHC sensor assembly is free of obstructions or coatings that could interfere with gas reaching the sensing element.

2. For ported sensor systems, inspect flow lines and fittings. Cracked, pitted, bent or otherwise damaged or deteriorated flow lines or fittings should be replaced.

3. The optional Foam Splash Guard is recommended for sensors used outside or in areas prone to high levels of airborne dust, oil droplets, or corrosive fumes. The Splash Guard helps prevent the sensor flame arrestor from becoming clogged. The Splash Guard and the flame arrestor must be cleaned periodically--the dirtier the environment, the more often they need to be cleaned. The Splash Guard should be cleaned with warm water and allowed to dry. The flame arrestor should be cleaned with a low residue solvent.

4. Before placing a sensor initially on line, check to see that the IR processor and sensor components are properly installed. The sensor should be vertical with the flame arrestor pointing down.

The sensor should be installed so that normal area and facility cleanup operations will not submerge the flame arrestor under water or other liquids.

The flame arrestor should be tightened securely in place.

Insure that all the connectors to the Interface module are securely seated.

Ascertain that the conduit box cover is tightly fastened to the conduit box.

6.1.2 Sensor Considerations

1. The Delphian FPIR CHC sensor has an expected service life of many years. Other than mechanical abuse the sensor should not deteriorate through use.

2. The IR Processor Module and IR Sensor assembly (after cleaning or replacing the flame arrestor) must be serviced if the local readout displays a failure or warning code as shown in Section 7, or if it does not display a stable gas concentration ($\pm 5\%$ LEL) while a known gas concentration is flowing through the sensor.

3. The flame arrestor is part of the sensor assembly. It should be checked for proper attachment and fit, and for signs of corrosion, dirt, or moisture. Any necessary cleaning or replacement can be performed at the Delphian factory or can be performed on location after removal with a special flame arrestor tool available from Delphian.

WARNING: The sensor contains open wires and an IR source operating at high temperature. The flame arrestor is required to be tightly in place before applying power to the sensor. If the flame arrestor is improperly treated or replaced its flame propagation protection could be impaired and an explosion could result in the presence of combustible gases.

WARNING: Flame arrestor shield must always be installed.

WARNING: If the user has obtained the flame arrestor tool from Delphian it should be used only by qualified people. THE AREA MUST BE DECLASSIFIED (FREE FROM COMBUSTIBLE GAS) BEFORE THE FLAME ARRESTOR IS REMOVED. If the sensor diagnostic indicates excessive dirt on the optics and/or a clogged flame arrestor the system should be cleaned as described in the maintenance section.

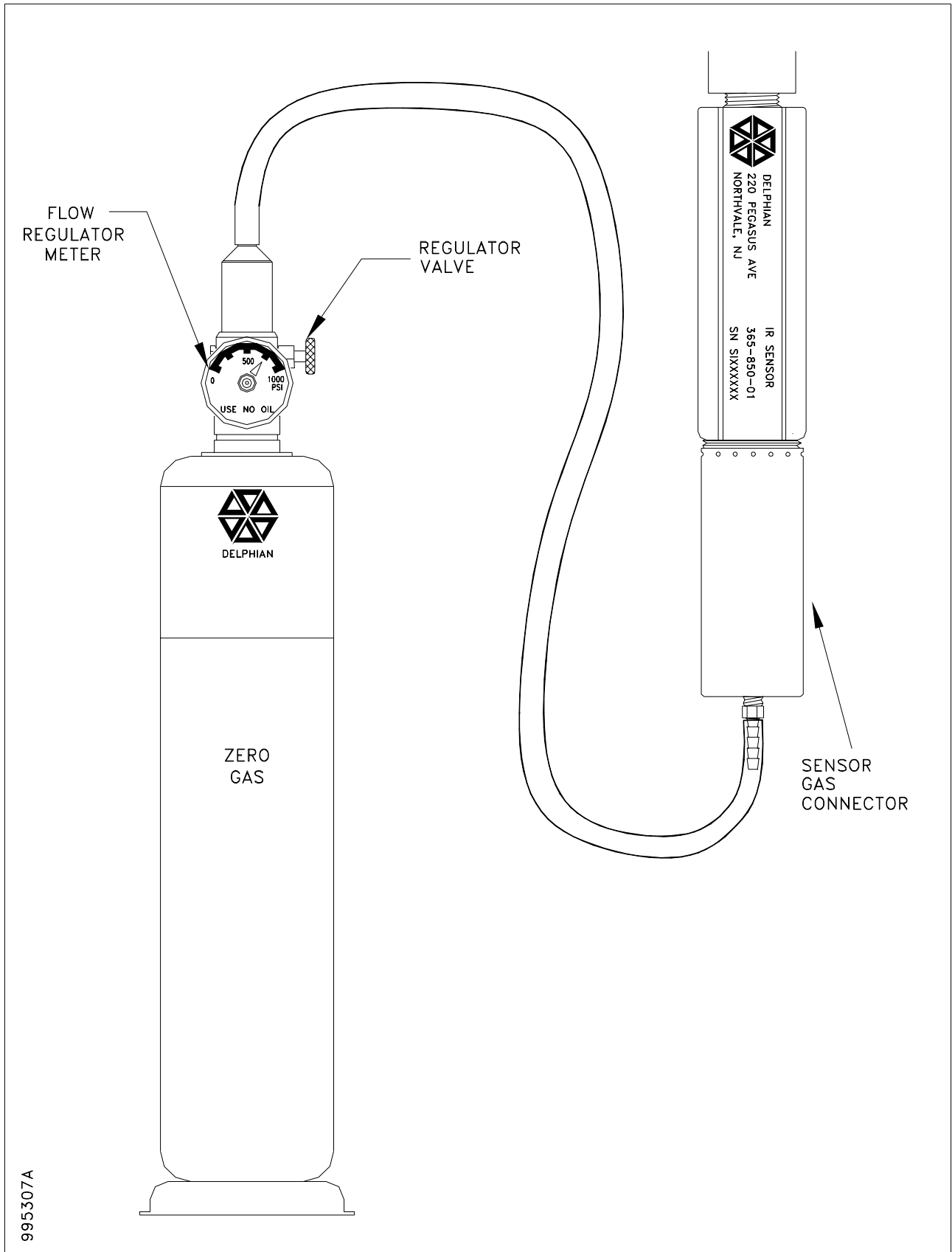

Figure 18: Flow Gas Calibration System (Drawing # 995307)

6.2 Sensor Operation Test

Procedures

6.2.1 General

WARNING - WHEN THIS EQUIPMENT IS FIRST INSTALLED IT SHOULD VERIFIED THAT NORMAL CONDITIONS EXIST BY OPERATIONAL CHECKS WITH ZERO GAS AND SPAN GAS FREQUENTLY FOR THE FIRST 30 DAYS BEFORE DECIDING TO GO TO EXTENDED INTERVALS. IT IS ADVISABLE TO SET INITIAL TESTS, AT LEAST EVERY THREE MONTHS, BEFORE GOING LONGER INTERVALS. DO NOT OPEN THE PROCESSOR CONDUIT BOX UNTIL THERE IS ABSOLUTELY NO COMBUSTIBLE GAS PRESENT.

Use zero gas to set the zero. Zero gas is clean, dry air, and is the only way of insuring a true zero signal. System zero adjustment using ambient air will introduce humidity and gas errors that depend on the amount of signal producing gases (combustible hydrocarbon gases and vapors) in the air. Test personnel may not be able to tell easily if there is a small release of gas or pocket of gas near the sensor while zeroing the sensor signal.

6.2.2 Initial System Check and Zero Adjustment

An initial function check can be made two hours after power is applied to the sensor. Delphian recommends a zero adjustment the first time the system is put into service.

6.3 How to Use the Flow Gas System

The same gas flow system is used for delivering zero calibration gas and for methane test gas to the sensor. The type "A" gas kit includes a regulator/valve assembly with sensor gas connector and carrying case, but does not include the Calibrator, Zero Gas and Test Gas. They must be ordered separately.

1. Screw the regulator/valve assembly into the connection at the top of the desired gas bottle. The regulator meter should read at least 1000 PSI on a new cylinder.
2. Make sure the plastic tubing is securely fastened to the valve assembly at one end and to the sensor gas connector at the other end.
3. Loosen allen screw and remove flame arrestor shield.
4. Screw the gas connector over the flame arrestor into the metal sensor housing.
4. Turn on the regulator valve.
5. After the test has been performed, turn off the gas and remove the connector from the sensor.

6.4 How to Adjust the Zero

The Zero Adjustment is started by holding the RED end of the Calibrator for approximately five (5) seconds over the "Zero" spot near the left lower corner of the processor display. The zero process is displayed by a rotating "0" on the left of the display and a steady countdown from "32" on the right. When the rotating 0 starts, the Calibrator can be removed.

When the procedure has ended, the rotating "0" disappears and the display shows the results:

1. **If the Zero adjustment is completed successfully**, the display shows "**done**" for 4 seconds and then goes back to the its previous state (on-line or off-line).
2. **If the Zero adjustment fails**, the display shows "**bAd 0**" for 4 seconds and then the FPIR reverts to the prior Zero and to its previous state (on-line or off-line). At any time while the "0" is rotating, touching reset with the Blue end of the Calibrator to Reset will cancel the process and restore the original zero. The display shows "**old 0**". If Reset is touched after **done** is displayed, it simply acknowledges the new reading and causes the detector head to go back immediately to its previous state.

WARNING: The Zero Adjust procedure will fail if the atmosphere contains excessive levels of hydrocarbon gases or vapors. Background readings equivalent to gas below 10%LEL, based on the current Zero Gas value will be zeroed out by the procedure. Background readings equivalent to gas in excess of 10%LEL will give rise to a failure of Zero Adjustment. In which event the display shows "**need 0 gas**"

NOTE 1: To override or force the zeroing sequence, when a "**need 0 gas**" is displayed, hold the RED end of the Calibrator for approximately four (4) seconds over the "Zero" spot near the left lower corner of the processor display. This **MUST** be performed within 10 seconds of seeing the "**need 0 gas**" display or a "**bAd 0**" will occur. If this happens, reset and start the zeroing sequence again.

NOTE 2: The Zero Adjustment procedure of the FPIR must be carried out with certified "Zero Gas."

NOTE 3: The Zero Adjust procedure of the FPIR sensor can be initiated either from the On-Line or the Off-Line state. At the conclusion of the procedure the sensor will return to the state in which the procedure was initiated. If the sensor is On-Line when the procedure is initiated, the sensor will take itself Off-Line only for the duration of the adjustment and return to On-Line as soon as the new Zero has been set.

6.5 How to Test Sensor Operation

In order to assure the user that gas is being recognized, the user should confirm the correct operation of the FPIR sensor by applying a known combustible gas/ air mixture to the sensor and checking the readout against the known concentration of the test gas. The detector does not need, nor is provision made for, adjustment or calibration with span gas. The sole purpose of the span gas test is to exercise the sensor functions and assure the user that the detector is operating properly. For instance, if the sensor were clogged, it would not show a fault condition but would not respond to gas. Only a gas test would uncover this problem.

Warning: There is no substitute for this test. It is strongly recommended that a span gas test be conducted on a regular basis and, at least as often as the Zero is checked or adjusted. It is recommended that Delphian 50% LEL methane be used to test detector operation because methane exercises all of the channels of the sensor.

6.5.1 Span Gas Function Test

The function check can be performed with the sensor on-line or off-line. If the sensor is on line, application of 50% LEL gas will cause all of the alarms at or below that point to activate. Use a higher concentration for the Remediator 855 system.

(Remediator 855 note: Concentrations above 75% LEL are not commercially available. Please consult the factory for your options).

1. To take the sensor off-line, hold the blue end of the Configuration Tool on the off-line spot on the display until the display shows **OFF**. To prevent accidental changes in the on/off line status, the Configuration Tool must be held on the spot for one second and should not be removed until the display changes to **OFF**.
2. Apply 50% LEL methane
3. If the reading is below 40% LEL or above 60% LEL, consider:
 - a. Checking the span gas concentration and accuracy
 - b. Re-zeroing the instrument
 - c. Checking the altitude setting
4. After you have finished the Span Gas Function Test and allowed the gas reading to drop below the alarm level, turn the sensor back on line by holding the blue end of the configuration tool to the off-line spot until the display shows **On**.

7. Troubleshooting & Repair

7.1 Warning Codes

In order to maintain uninterrupted gas detection, warning codes are not transmitted on the 4-20 mA line as long as that failure does not prevent the Detector Head from operating. The IR detector head sends only gas LEL readings, operator induced codes and failure codes on the 4-20 mA line. The type of gas detected, service and warning alarms are displayed at the Detector Head and are transmitted on the digital line.

7.2 General Trouble Shooting Guide

4-20 mA Signal Current Codes & Fatal Error Alarms			
		DETERMINATOR 850	REMIADIATOR 855
Warning	>23.2 ma	Over-range (>120% LEL)	
	20.0 mA	Full Scale (100% LEL)	100% by volume
Functioning OK	4.0 to 23 mA	% LEL Displayed	% by volume displayed
Fail	<4 mA 10% below zero	Signal inverts to 0.2 mA	
Operator Induced Codes	2.3 mA	CPU POST successful, no output, warm-up	
	2.1 mA	Off-line	
	1.9 mA	Zero Adjust Failed - taken offline	
	1.7 mA	Zero Adjustment in progress-Sensor offline	
	1.5 mA	Voltage too high to function properly (>32VDC)	
	1.3 mA	Sensor missing or not connected properly	
	1.1 mA	Light too low to function properly	
Detector Failure Codes	0.9 mA	Filament failed	
	0.7 mA	Voltage too low to function properly	
	0.5 mA	Sensor Module circuit fail	
	0.3 mA	Processor Module circuit fail	
	<0.2 mA	No power, system fault	

Table 7: 4 - 20 mA Signal Current Codes and Fatal Error Alarms

Warning codes (Error Codes) begin with EE. Warnings are displayed at the detector head but are not transmitted on the 4-20 mA line so as not to interrupt gas detection.

Failure codes begin with FF. Failure codes are transmitted on the 4-20 mA line. There is a complete list of displayed messages and their meanings on the following page.

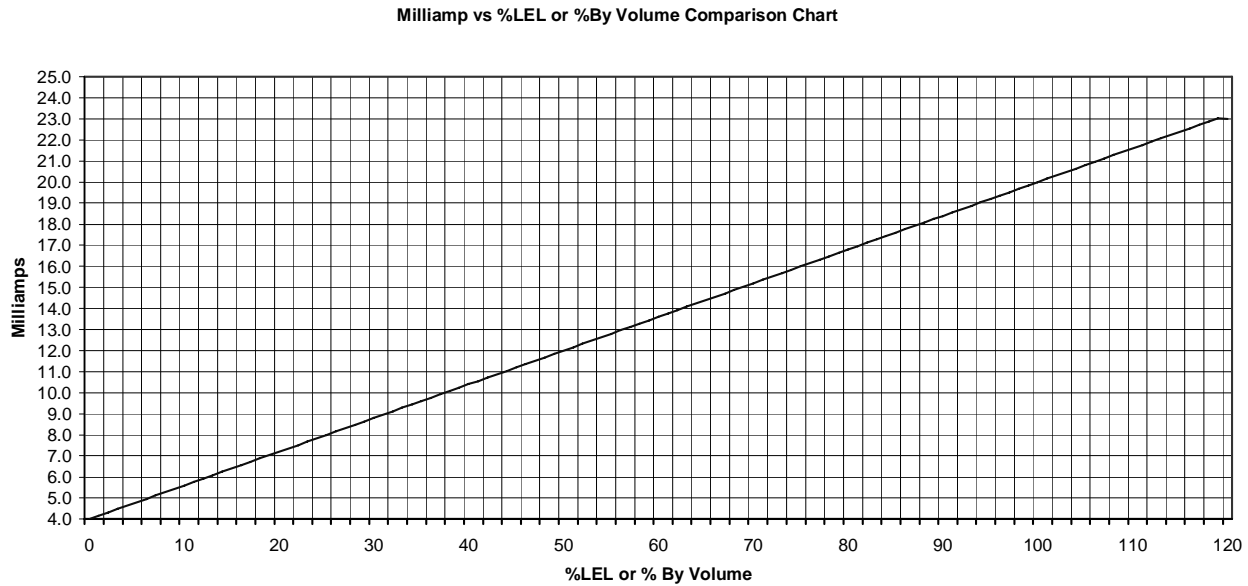

Figure 19: Relationship between the input and the output: mA to LEL Graph

7.3 Cleaning the optics

1. Although the IR Sensor's optical tube is well protected by both the flame arrestor and the Foam Splash/Dust Guard, degradation of the reflective and transmissive surfaces of the optical tube may occur. These surfaces may slowly be coated by dust particles, other particulates, precipitates or deposited chemical vapors such as oils. It is therefore recommended that cleaning of the optical tube be performed either on a regular scheduled basis and when the processor outputs a 1.1mA signal and/or displays an EE001 or FF001 error or failure code.

2. To perform the optical cleaning, removal of the protective Flame Arrestor on the FPIR Sensor is necessary. Use the Delphian Flame Arrestor Tool. The area may need to be declassified if installed in a hazardous location.

3. Remove the flame arrestor by using the Flame Arrestor Tool designed for this purpose.

Caution: using a wrench or plier on the sintered metal flame arrestor to unscrew it is likely to damage the flame arrestor. This will reduce the integrity of the flame arrestor as well as deforming it to the point of not being able to slide it off of the optical tube it is protecting.

4. Cleaning may be performed with power on, but removing power from the unit is recommended. Use the recommended low-residue, optical cleaner, (see Delphian Parts List), to clean optics by inserting the small tube up into the holes located on the bottom of the optical tube. Spray several times allowing the cleaner to drain between sprays. When the unit's drain-off is perfectly clear, allow the solution to evaporate for at least 30 minutes.

5. Replace Flame Arrestor and secure using Flame Arrestor Tool. Reinstall flame arrestor shield. **Do not overtighten.**

6. Connect power

THE DISPLAY SHOWS	THE DISPLAY MEANS
Normal Display Modes	
steady number	LEL level
occasional "gas" and "=###="	This occurs at about 15 second intervals when gas has been detected. If the gas can be identified, ## identifies the gas. Otherwise ### is 000.
LO### or HI### or HH### and LO, HI or HH is flashing	The detected gas is either above the threshold for the displayed alarm level, or it exceeded the threshold previously and has been latched.
Startup Sequence (this sequence occurs only when power is first applied)	
alternating CodE and #-##	Version number of the program
HEAD ##-## ###	Unique detector head identification ##-## is the manufacturing month and year ### is the manufacturing sequence number
sequence of =###= with ### going up	Identifies gases this unit is capable of detecting and that are enabled
alternating cold # a number	Passed self-test, warming up. Number is a countdown to zero
Warnings (These messages may appear briefly during normal operation. Gas detection is not interrupted)	
LO SUPLy	Power supply is low but not too low to operate
HI SUPLy	Power supply is high but not too high to operate
Fails (these messages occur when the unit is not able to perform gas detection. The message is always FAIL followed by one or two additional displays to identify the failure.)	
SEnSr Error	Detector head is missing or its data tables have been corrupted
CPU Error	Data tables in the processor have been corrupted . Consult factory..
bulb dEAd	Broken filament. Replace bulb.
LEL nEg	Signal level is well below zero.
HEA dEAd	Heater is open-circuited
LO SUPLy	Incoming power supply is too low for reliable operation
HI SUPLy	Incoming power supply is too high for reliable operation
OP bLoc	Optics blocked more than -25% of zero

Table 8: List of Display Messages and Their Meanings

8. Specifications

NOTE: All specifications given here are subject to change without notice.

8.1 System Specifications

Dimensions (inches)

Conduit box with sensor 13"L x 6.5"W x 4.5Depth

Vibration and Shock

Tests show no sensitivity to normal shock and vibration

MTBF at 70° F

8 years

Accuracy

Determinator:

4% LEL (up to 120% LEL). 20% of reading (from 120%LEL to 500%LEL)

The Determinator can display up to 999% LEL. Accuracy above 500% LEL has not yet been determined.

Remediator:

+/- 0.5 %by volume up to 10% by volume
20% of reading above 10% by volume

Repeatability

Determinator:

+/- 3% up to 120% LEL

Remediator:

+/- 3%

Response Time

Determinator:

< 12 seconds to 60% of gas concentration (without splash guard) when exposed to 100% LEL

Recovery Time

< 40 seconds to 10% of gas concentration (without splash guard)

Measurement Range

Determinator: 4 - 999% LEL

Remediator: 0.2 - 99.9% by volume

Humidity

Not affected by 0 - 99% relative humidity in a temperature range of 0-70C

Flooding

Determinator:

The detector is not flooded by high concentrations of gas. It will read up to 999% LEL on the LED display and will transmit up to 120% LEL on the 4-20 mA output.

Remediator:

The detector is not flooded by high concentrations of gas.

Operating Temperature

-30C to +70C (-22F to +158F)

Pressure

Normal variations in atmospheric pressure will not affect the detector.

Power

Input voltage: 24 VDC nominal (20 to 32 VDC) Power: < 4 watts

Input is voltage polarity protected.

Input lines have surge suppressors and are fused to prevent damage from electrical transients.

Output Signals

The detector is jumper selectable to transmit either 4-20 mA or 1-5 mA (used by Delphian's analog Controllers). The detector has digital RS-422/485 outputs.

Hazard Classification

Class 1, Division 1, Groups C, D

RFI Immunity

Less than 1% LEL change with transceiver keyed within two feet of detector head.

Poisoning Gases

None

Blocking Gases

Acetylene

High concentrations of ammonia

Altitude

Adjustable -6,000 ft to +15,000 ft

Calibration

Zero calibration required infrequently
Span calibration not required

Storage Limits

Components should be stored in a typical office environment.

Approvals**FM Approvals**

FM Approvals Class No. 3600: Electrical Equipment For Use In Hazardous (Classified) Locations General Requirements

FM Approvals Class No. 3615: Explosionproof Electrical Equipment General Requirements.

FM Approvals Class No. 6310, 6320: Combustible Gas Detectors

FM Approvals Class No. 3810: Electrical and Electronic Test Measuring and Process Control Equipment

The following are included in the FM Approval:

- Model 850 Determinator IR Combustible Hydrocarbon Detector Head; P/N 364-850-01 (Aluminum) and P/N 364-850-02 (Stainless Steel)
- SLAM Assembly ; Relay Module P/N 360-160-01, Extension cable P/N 364-330-02, and SLAM Conduit box kit P/N 364-382-01
- Calibration kit P/N 360-945-02, Calibration zero Gas Cylinder P/N 361-774-01, Methane gas cylinder P/N 360-671-01, Gas test adapter P/N 364-332-01, and configuration tool P/N 361853-02.

The following are not included in the FM Approval:

- Use of Determination Factors for detecting gas or vapors other than methane
- Model 855 Remediator
- Use of RS-422/485 Serial communications function
- Use of foam Splash/Wind/Dust guard

This approval does not include or imply approval of apparatus to which the subject instrumentation may be connected. In order to maintain a FM Approved system, the apparatus to which this instrument is connected must also be FM Approved gas detection apparatus.

CSA Approvals

CSA Std C22.2 No. 30-M1986: Explosion-Proof Enclosures for Use In Class I Hazardous Locations.

CSA Std C22.2 No. 142-M1987: Process Control Equipment.

CSA Std C22.2 No. 152-M1984: Combustible Gas Detection Instruments.

9. Part Numbers and Suggested Spares

Part	Part Number		Suggested Spares
	aluminum	stainless steel	
Determinator FPIR	364-850-01	364-850-02	
Remediator FPIR	364-855-01	364-855-02	
(includes Sensor, Conduit Box, Interface Module & Processor Module)			
Detector Head			
Three Hub Conduit Box	361-868-02		1 per 20 points
Processor Module Determinator	370-850-xxx		1 per 20 points
Processor Module Remediator	370-855-xxx		1 per 20 points
Interface Module (both Determinator & Remediator)	367-850-01		1 per 20 points
Sensor (aluminum body) Determinator	365-850-01		1 per 20 points
Sensor (stainless steel body) Determinator	365-850-02		1 per 20 points
Sensor (aluminum body) Remediator	365-855-01		1 per 20 points
Sensor (stainless steel body) Remediator	365-855-02		1 per 20 points
Foam Splash Guard	361-707-02		1 per 5 points
Test Gas Kit			
Type A calibration kit	360-954-02		1 per system
Zero gas cylinder	361-774-01		One year supply
Methane gas cylinder	360-671-01		One year supply
Gas Test Adaptor (zeroing)	364-332-01		1 per system
REMIATOR NOTE: Gas concentrations above 75% LEL are not commercially available. Please contact the factory to discuss your options.			
Configuration Tool	361-853-02		1 per 20 points
Optics Cleaning Spray	850-186-01		1 case
Reclamation Adaptor	364-338-02		as required
Flame Arrestor Tool	950-142-01		1 per 20 points
SLAM Kit			
SLAM (Relay Module)	364-160-01		1 per 20 points
Extension Cable	364-330-02		
SLAM Conduit Box	364-382-01		
Replacement Parts			
Interface Board Fuse	480-102-01		1 per 20 points
Flame Arrestor Screw	500-150-01		1 per 20 points
Flame Arrestor	364-319-01		1 per system
Flame Arrestor Shield	364-389-01		1 per system
Owners Manual	900-105		
Gas Monitoring Handbook	980-042		

Index

A

Accessibility 34
Accessories 8, 10
Accuracy 50
Acetylene 23
Adapters 8
Air Currents 34
Alarm Setup Procedure 37
Alarms, Setting 37
Altitude 24, 51
Ammonia 9, 50
Analog Current Outputs 11
Approval, agency 10, 12, 51
Area Declassification 8, 30
Atmosphere, Corrosive 11
Atmospheric Pressure 50

B

BASEEFA 10, 11
Blocking 9, 11, 23
Blocking Gases 50
Breathing apparatus 11
Broken sensors 8
Butane 25

C

Cable lengths 26
Calibration 51
 Gas 25
Calibrator Colors 37
Canadian Electrical Code 6
Canadian Standards Association 12
Carbon monoxide 11
Catalytic Sensors 20
 Advantages 20
CENELEC 6
Choosing Gases 40
Chopping the Signal 16
Clean Air 45
Cleaning
 Spray, optics 8
 Optics 48
 Sensor 43
Codes 35
 Error 48
 Failure 48
 Warning 48
Color 15
Combustible gas 11, 20
Compatibility 11
Component failure 36
Conduit 28, 34
 conduit box 8
Configuration 27
Configuration Tool 37
Configuring Sequence 37
Contaminating Gases 9
 corrosive atmospheres 10
CSA 10, 11, 12, 51

D

- DCS 6
- Declassification of area 37
- Description, general 6
- Desensitizing Agents 9, 23
- Detector, Elevation 36
- Detector Head 6, 10, 11, 36
- Determination channels 40
- Determination Table 25, 40, 42
- Determinator
 - accuracy 50
 - Calibrator 39
 - Components 36
 - Repeatability 50
- Dimensions 50
- dirt 8
- Discrimination Table 25
- Dispersion of Gas/Vapor 34
- Display 37, 47
- Drain Plugs 34
- Drawing, Configuration 27
- Drawing, FPIR Detector Head 6
- Drawing, FPIR Detector Head in Sections 7
- Drawing, Installation 27
- Drawing, Relay Module Wiring 31
- Dust Guard 8
- Dust Protection 34

E

- Electrical Conduit Seal
 - Drawing, Conduit Seal 29
- Electromagnetic radiation 14
- Electromagnetic Spectrum 14
- Elevation
 - altitude 40
 - detector 36
- EMI 23, 34
- encapsulant 8
- Energy 14
- Error Codes 48
- Ethane 25
- Ethanol 17
 - Graph 19
- Ethylene 17
 - Graph 19
- explosion proof conduit box 8
- Explosion-proof integrity 10
- Explosions 9
- Exposures 35

F

- FM Approvals 10, 11, 12, 51
- Failure Codes 48
- Fatal Error Alarms 47
- Filters 16
- Flame Arrestor 11, 43, 48
 - Clogged 11
 - Precautions 11
 - shield 9
 - Tool 48
- Flexirack 26
 - Wiring Diagram 32
- Flooding 23, 50
- Flow Gas Calibration System 44
- Flow Gas System, How to Use 45
- FM Approvals 10, 11, 12, 51
- Foam Splash 8
- Frequency 14
- Function Check 11, 25, 45

G

- Gas Alarms, Setting 37
- Gas identification 42
- Gas Monitoring Handbook 20
- Gas signatures 24
- Gas Types 25, 40
- Gas/Vapor, Dispersion 34
- Gases
 - choosing 40
 - turning on and off 25, 40
 - Vapor Density 33
- General Description 6
- Graph, mA to LEL 48

H

- Hazard Classification 50
- Hazardous Locations 6
- Heating 35
- Hold Delays 37
- Humidity 17, 23, 50
- Hydrogen 22
- Hydrogen sulfide 11

I

- Infrared 13
 - Detecting Combustible Gases 17
- Infrared Detectors
 - Advantages 20
 - Essential Components 15
- Infrared Fundamentals 13
- Infrared Gas Detectors, How They Work 15
- Infrared, Measurement 14
- Infrared, Nature of 13
- Infrared Sensors
 - Sensors, Catalytic 20
- Infrared Spectral Absorbance 13
- Infrared vs Catalytic Sensors
 - Catalytic vs Infrared Sensors
 - Sensors, Catalytic vs Infrared 21
- Inhibiting 9
- Input and the output, relationship 48
- Installation 26
 - Interface Module 30
 - Precautions 10
 - The Sensor 28
 - The Processor 28
- Interface Module 6, 8, 11
 - Installation 30
- Interfering Agents 9, 23
- Interfering Gases 20
- Interior 35
- International Electrotechnical Commission 6
- Introduction 6

L

- Labeling 10
- Light 13, 14
- Light Detectors 16
- Light Spectrum 13
- Limited Warranty 8
- Locating Sensors 33

M

- mA to LEL Graph 48
- Maintenance 9, 10, 12, 25, 43
 - Sensor 30
- Markings 10
- Matter 15
- Measurement Range 50
- Methane 17, 25, 41
 - Graph 18
 - Test Gas 8
- Moisture Protection 34
- Monitoring
 - Perimeter 34
- MTBF 50

N

- NEG 23
- Negative sensor readings 23

O

- Obstructions 34
- Open Path 17
- Operational Checks 43
- Operational Considerations 17
- Optics, Cleaning 9, 48
- Optics Cleaning Spray 8
- Output, RS-422 11, 24
- Output Signals 50
- Overview 6
- Oxygen Deficiency 11

P

- Part Numbers 52
- Particle Model
 - Model, Particle 13
- Path Length 16
- Perimeter Monitoring 34
- Photoacoustic 17
- Photoconductive Quantum Detectors 17
- Photovoltaic Quantum Detectors 17
- PLC 6
- Pneumatic 17
- Point Sensors 17
- Poisoning Gases 9, 50
- Poisons 20, 23
- Ported Adapters 8
- Ported Sensors 9, 43
- Power 50
- Preprogrammed 37
- Pressure 17, 22, 24, 50
- Processor Face 37
- Processor Module 6, 8, 11
 - installing 31
 - Operation 24
 - Signal 24
- Programmable Alarms 40
- Programming 37
 - Automatic Reset Without Saving Change 40
 - Gases 41
 - Resetting Without Saving Changes 40
 - Returning to Online Status 40
 - Saving the changes 40
 - Elevation 40
- Propane, Absorbance Spectrum of 14

R

- radiation, ultraviolet 9
- Ray Model
 - Model, Ray 13
- Reclamation Adaptor 8
- Record Keeping 12
- Recovery Time 50
- Reference Signal 16
- Regulator Valve 45
- Relay Module 8, 31
 - Installation 31
- Reliability 12
- Remediator 20
 - accuracy 50
 - Components 36
 - repeatability 50
- Repeatability 50
- Replacement Parts 52
- Response Time 50
- RFI 23, 34, 50
- RMA# 9

S

- Safety 9
- SAGE 11
- Sampling 9
- Saturation 23
- sea level 40
- Seals 34
- Selective Absorption 16
- Selectivity 17
- Sensor
 - Cleaning 43
 - Health Monitoring 41
 - Maintenance 30
- Sensor
 - Accessories 11
 - accuracy 10
 - adjustments 9
 - Blocking 23
 - Display 42
 - Installation 10, 28

- Drawing, Sensor Installation 28
 - Interferences 23
 - Location 33
 - mounting 10
 - Operating Principle 22
 - Operation Test 45, 46
 - Orientation 28, 34
 - Poisons 23
 - readings, negative 23
- Sensor
 - Science 22
 - Several Gases Present 25
 - Damaged 9
 - Ported 43
- Setting Gas Alarms 37
- Shipment, Damage 11
- Shock 50
- Shop Test 33
- Signal Current 24
- Signal Current Codes 47
- Signals, Output 50
- Site Selection 33
- SLAM (Relay Module) 6, 8, 11, 31, 52
 - Installation 31
 - Wiring, Drawing 31
- Span Gas Function Test 46
- Spare Parts 52
- Specifications 50
- Spectral Absorbance 13
- Splash Guard, foam 11, 30, 43
- Stand Alone
 - Description 36
 - Components 36
 - Operation 36
- Steam 11
- Storage life 11, 51
- System Check 43, 45
- System Faults 10
- System Start-up 36

T

Temperature 10, 17, 50
 Limitations 34
 Range 10
 high 9
Test Gas 8
Theory of Operation
 Infrared Detector, Theory of Operation 20
Thermal Detectors 16
Toxic Gases 11
Transfer Factors 25
Trouble Shooting Guide 47
Turning ON/OFF Gases 25

U

Unpacking 11

V

Vapor Density 33
Ventilation 35
Vibration 34, 50
Visual Checks 43

W

Warning Codes 47, 48
Warnings 9
WARRANTY 8
Water 8, 9, 11
waterproof 8
Wave Model 13, 14
Wavelengths 13, 14, 17, 24
Wind 8
Wire Size Information 26
Wiring 26
 Wiring Diagram, Standalone System 33
 Wiring Diagrams, Flexirack System 32
 Wiring, Relay Module 31
 Wiring, SLAM 31

X

X-rays 15

Z

Zero 9
Zero, Adjust 45
Zero Gas 45
Zero Test Gas 8