



MGS-400

Refrigerant Gas Detectors

for Machinery Rooms, Cold Rooms & Freezers



Refrigerant Leak Detection

P/N: 1100-2294 | January 2019 Revision 0

User Manual

WARRANTY POLICY

Bacharach, Inc. warrants to buyer that at the time of delivery this product will be free from defects in material and manufacture and will conform substantially to Bacharach, Inc.'s applicable specifications. Bacharach's liability and buyer's remedy under this warranty are limited to the repair or replacement, at Bacharach's option, of this product or parts thereof returned to seller at the factory of manufacture and shown to Bacharach, Inc.'s reasonable satisfaction to have been defective; provided that written notice of the defect shall have been given by buyer to Bacharach, Inc. within one (1) year after the date of delivery of this product by Bacharach, Inc.

Bacharach, Inc. warrants to buyer that it will convey good title to this product. Bacharach's liability and buyer's remedy under this warranty of title are limited to the removal of any title defects or, at the election of Bacharach, to the replacement of this product or parts thereof that are defective in title.

THE FOREGOING WARRANTIES ARE EXCLUSIVE AND ARE GIVEN AND ACCEPTED IN LIEU OF (I) ANY AND ALL OTHER WARRANTIES, EXPRESS OR IMPLIED, INCLUDING WITHOUT LIMITATION THE IMPLIED WARRANTIES OF MERCHANTABILITY AND FITNESS FOR A PARTICULAR PURPOSE: AND (II) ANY OBLIGATION, LIABILITY, RIGHT, CLAIM OR REMEDY IN CONTRACT OR TORT, WHETHER OR NOT ARISING FROM BACHARACH'S NEGLIGENCE, ACTUAL OR IMPLIED. The remedies of the buyer shall be limited to those provided herein to the exclusion of any and all other remedies including, without limitation incidental or consequential damages. No agreement varying or extending the foregoing warranties, remedies or this limitation will be binding upon Bacharach, Inc. unless in writing, signed by a duly authorized officer of Bacharach.

Register Your Warranty by Visiting: www.mybacharach.com

SERVICE POLICY

Bacharach, Inc. maintains a service facility at the factory. Some Bacharach distributors / agents may also have repair facilities; however, Bacharach assumes no liability for service performed by anyone other than Bacharach personnel. Repairs are warranted for 90-days after date of shipment (sensors, pumps, filters and batteries have individual warranties). Should your analyzer require non-warranty repair, you may contact the distributor from whom it was purchased or you may contact Bacharach directly.

If Bacharach is to do the repair work, send the monitor, prepaid, to the closest service center. Prior to shipping equipment to Bacharach, visit www.mybacharach.com for a Returned Merchandise Authorization Number (RMA #). All returned goods must be accompanied by a RMA #. Pack the equipment securely (in its original packing, if possible), as Bacharach cannot be held responsible for any damage incurred during shipping to our facility. Always include your RMA #, shipping address, telephone number, contact name, billing information and a description of the defect as you perceive it. You will be contacted with a cost estimate for

expected repairs prior to the performance of any service work. For liability reasons, Bacharach has a policy of performing all needed repairs to restore the monitor to full operating condition.

NOTICES

Product improvements and enhancements are on-going, therefore the specifications and information contained in this document may change without notice.

Bacharach, Inc. shall not be liable for errors contained herein or for incidental or consequential damages in connection with the furnishing, performance, or use of this material.

No part of this document may be photocopied, reproduced, or translated to another language without the prior written consent of Bacharach, Inc.

Copyright © 2019, Bacharach, Inc., All Rights Reserved.

BACHARACH is a registered trademark of Bacharach, Inc. All other trademarks, trade names, service marks and logos referenced herein belong to their respective companies.

Table of Contents

Table of Contents	3
Service Center Locations	Error! Bookmark not defined.
1. Introduction	7
1.1 About this Manual	7
1.2 Conventions	7
1.2.1 Short Form Instructions	7
1.2.2 Iconography	8
1.3 General Safety Statements	8
1.4 Safe Connection of Electrical Devices	9
2. Product Descriptions	10
2.1 Intended Uses / Applications	10
2.2 MGS-410	10
2.2.1 MGS-410 Product Overview	10
2.2.2 MGS-410 Design Features	11
2.2.3 MGS-410 Components	12
2.3 MGS-450	13
2.3.1 MGS-450 Product Overview	13
2.3.2 MGS-450 Design Features	14
2.3.3 MGS-450 Components	15
2.4 MGS-460	17
2.4.1 MGS-460 Product Overview	17
2.4.3 MGS-460 Components	18
3. Installation	21
3.1 General Information	21
3.2 Restrictions	22
3.3 Mechanical Installation	22
3.4 Electrical Installation	22
3.4.1 Preparations	22
3.4.2 Power & Signal Wiring	23
3.4.3 Relay Wiring	24
3.4.4 Installation of Remote Sensing Head (MGS-460)	24

3.4.5	Connecting to MGS-408 Gas Detection Controller	25
3.4.6	Modbus RTU RS-485 Interface	25
3.4.7	Conclusion	26
4.	Operation	27
4.1	Overview of Normal Operation	27
4.1.1	Applying Power & the Start-up Sequence	27
4.1.2	Verifying Analog Signals	28
4.1.3	Verifying the Modbus Signal	29
4.1.4	Status Indication	29
4.1.5	Switch Functions	30
4.1.6	Reset System to Factory Default Settings	31
4.2	MGS-400 Smartphone Application	31
4.2.1	Enable Bluetooth® Connection	32
4.2.2	Checking Status	32
4.2.3	Instrument Configuration	34
4.2.3.1	Change Alias	34
4.2.3.2	Change Unlock Code	34
4.2.3.3	Change Bluetooth Passcode	35
4.2.3.4	Reset to factory defaults	35
4.2.3.5	Alarm Configuration	35
Low Alarm Setpoint		35
High alarm Setpoint		36
Alarm Latching		36
4.2.3.6	Modbus Configuration	37
Address		37
Baud Rate		37
Stop Bits		37
Parity		37
Enable 120Ω Termination		38
4.2.3.7	Output Configuration	38
Analog Output Range		38
Buzzer		39
Relay Failsafe		39

Alarm Delay	39
Analog Zero Adjust	39
Analog Span Range	40
5. Care & Maintenance	41
5.1 Maintenance Intervals	41
5.2 Adjustments	42
5.2.1 Introduction	42
5.2.2 General Calibration Procedure	43
5.2.3 Zero Adjustment	43
5.2.4 Span Adjustment	45
5.2.5 System Bump Test	46
5.3 Troubleshooting	47
5.3.1 Hexadecimal Format	47
5.3.3 Fault Codes	47
5.4 Sensor Maintenance	49
5.4.1 Components Overview	49
5.4.2 Replacing the Sensor Module	51
5.5 Cleaning the Instrument	51
6. Additional Information	52
6.1 Sensor Principle	52
6.1.1 Electrochemical Sensors	52
6.1.2 Catalytic Bead Sensors	52
6.1.3 Semiconductor Sensors	53
6.1.4 Infrared Sensors	54
6.2 Disposing of the Instrument	54
6.2.1 Disposing of the Electrical & Electronic Equipment	54
6.2.2 Disposing of Sensors	54
6.3 Technical Specifications	55
6.3.1 General Specifications	55
6.3.2 Sensor Specifications	57
6.4 Modbus Registers	58
6.4.1 Integration - Dynamic Sensor Data	58
6.4.2 Integration - Static Sensor Data	59

6.4.3 Integration - General System Setup	61
6.4.4 Integration - Calibration	63
6.4.5 Integration - User Debug Tools	63
6.4.6 MGS Compatibility - Status Flags	64
6.4.7 Integration - Status Flags	64
6.4.8 MGS Compatibility - Clear Special States	64
6.4.9 Integration - User Tasks	65
7. Ordering Information	66
7.1 Part Numbers	66
7.1.1 MGS-410 Configurations	66
7.1.2 MGS-450 Configurations	69
7.1.3 MGS-460 Configurations	75
7.1.4 MGS-400 Series Accessories	78
7.1.5 MGS-400 Pre-calibrated Sensor Modules	78
7.2 Service Center Locations	80

1. Introduction

1.1 About this Manual

Thank you for investing in a Bacharach MGS-400 Gas Detector. To ensure operator safety and the proper use of the gas detector, please read the contents of this manual for important information on the operation and maintenance of the instrument.



IMPORTANT: Before installing this product, carefully read and strictly follow the instructions in the manual.

1.2 Conventions

1.2.1 Short Form Instructions

This document uses a short form for describing steps (e.g. executing a command).

Example:

Accessing sensor calibration.





Short Form Instructions:

To select access sensor calibration: Home Tab → Calibrate → enter Unlock Code

Steps Required:

1. Open the Home Tab.
2. Select Calibrate.
3. When prompted, enter the Unlock Code to access calibration screen.

1.2.2 Iconography

Alert	Icon	Description
Danger		Imminently hazardous situation which, if not avoided, will result in death or serious injury.
Warning		Potentially hazardous situation which, if not avoided, could result in death or serious injury.
Warning		Potential electrical shock hazard which, if not avoided, could result in death or serious injury.
Caution		Potentially hazardous situation which, if not avoided, could result in physical injury or damage to the product or environment. It may also be used to alert against unsafe practices.
Important		Additional information on how to use the product.

1.3 General Safety Statements



IMPORTANT: Before using this product, carefully read and strictly follow the instructions in the manual. Ensure that all product documentation is retained and available to anyone operating the instrument.



DANGER: This instrument is neither certified nor approved for operation in oxygen-enriched atmospheres. Failure to comply may result in personal injury or death.



WARNING: Use this product only for the purposes specified in this document and under the conditions listed.



WARNING: This instrument has not been designed to be intrinsically safe for use in areas classified as being hazardous locations. For your safety, DO NOT use it in hazardous (*classified*) locations.



WARNING: In the event of an alarm or over-range condition, the sensor must be recalibrated to ensure continued accuracy.



WARNING: This product must be recalibrated if installed in a non-room condition environment (*i.e. temperature or humidity extremes*).



WARNING: The gas diffusion path can become occluded (*moisture, dust, debris, frozen condensation*) over time resulting in reduced or complete lack of gas detection and alarming function. Routine visual inspection of the gas detector and bump testing are suggested to ensure proper gas detection and alarm function.



CAUTION: Except for maintenance detailed in this manual, these products should only be opened and / or serviced by authorized Bacharach personnel. Failure to comply may void the warrant.



CAUTION: Operator assumes responsibility for complying with all laws, rules and regulations governing the use of this product.



CAUTION: Use only genuine Bacharach parts and accessories. Failure to comply may impair the operation of the product and / or void the warranty.



CAUTION: Only operate the product within the framework of a risk-based alarm signaling concept.

1.4 Safe Connection of Electrical Devices



WARNING: Before connecting this instrument to electrical devices not mentioned in this manual, consult the manufacturer or a qualified professional. Failure to comply may result in injury and / or damage to the product.

2. Product Descriptions

2.1 Intended Uses / Applications

Bacharach MGS 400 Gas Detection Series instruments continuously monitor ambient air (*indoor or outdoor*) for the following gas types:

- Refrigerants
- Oxygen
- Toxic and combustible gases

The instruments may be purchased in the following configurations:

- MGS-410 - IP66
- MGS-450 - IP41
- MGS-450 - IP66
- MGS-460 - IP66 with Remote IP66 Sensor

MGS-400 gas detectors may be connected to a Bacharach's MGS-408 Gas Detection Controller or a third-party device capable of accepting digital and/or analog outputs from the gas detectors, such as a Building Management System (BMS) or Programmable Logic Controller (PLC). With the integrated audio-visual alarm indication, an instrument can be operated as a stand-alone unit (with additional local alarm signaling as required).



WARNING: This instrument is neither certified nor approved for operation in oxygen-enriched atmospheres. Failure to comply may result in EXPLOSION.



WARNING: This instrument has not been designed to be intrinsically safe for use in areas classified as being hazardous locations. For your safety, DO NOT use it in hazardous (classified) locations.

2.2 MGS-410

2.2.1 MGS-410 Product Overview

The Bacharach MGS-410 continuously monitors indoor or outdoor ambient air for the following gases: refrigerants, oxygen, toxic and combustible gases.

The instrument may be purchased in the following configuration: IP66.

With the integrated Modbus communication, the instrument can be operated as a stand-alone unit or integrated with Bacharach's MGS-408 8 Channel Modbus Controller. Or a third-party device capable of accepting digital outputs from the gas detectors, such as a Building Management System (BMS) or a Programmable Logic Controller (PLC). The instrument is designed to be installed in non-classified, non-hazardous, permanent locations.



2.2.2 MGS-410 Design Features

Transmitter construction:

- IP66 rated ABS enclosure

Power options

- 24 VAC
- 19.5 to 28.5 VDC

Diagnostic/status LED (*3 color: green, orange and red*)

Digital output Modbus RTU signal

Bluetooth communication allows for full instrument configuration, initiation of calibration, bump test and functional test mode, and viewing of status information via the corresponding Bacharach iOS / Android app.

Pre-calibrated sensor exchange modules can be used for maintenance of the instrument instead of performing gas calibration on site.

Non-intrusive magnetic wand can be used to initiate calibration of the device.

2.2.3 MGS-410 Components

This product uses semiconductors which can be damaged by electrostatic discharge (*ESD*). When handling the PCB, care must be taken so that the electronics are not damaged.



#	Component Description
1	M16 Cable Glands (x4)
2	Rubber Gasket
3	Digital Connection / Modbus (<i>In</i>)
4	Digital Connection / Modbus (<i>Out</i>)
5	Tactile Switch #1
6	Tactile Switch #2
7	Ribbon Cable Connection (<i>To Sensor</i>)
8	Power Connection (<i>In</i>)

9	Internal Alarm Buzzer
10	Power Connection (<i>Out</i>)
11	Magnetic Switch #1
12	Magnetic Switch #2

2.3 MGS-450

2.3.1 MGS-450 Product Overview

The Bacharach MGS-450 continuously monitors indoor or outdoor ambient air for the following gases:

- refrigerants
- oxygen
- toxic and combustible gases.

The instrument may be purchased in one of two configurations:

- MGS-450 - IP41
- MGS-450 - IP66

With the integrated Modbus communication, analog output and relays, the instrument can be operated as a stand-alone unit or integrated with Bacharach's MGS-408 8 Channel Modbus Controller. or a third-party device capable of accepting digital and/or analog outputs from the gas detectors, such as a Building Management System (BMS) or a Programmable Logic Controller (PLC). The instrument is designed to be installed in non-classified, non-hazardous, permanent locations.



2.3.2 MGS-450 Design Features

Transmitter options:

- IP41 or IP66 rated ABS enclosure

Power options

- 24 VAC
- 19.5 to 28.5 VDC

Diagnostic/status LED (3 color: green, orange and red)

Configurable output signal options

- 3x Relays (*high alarm / low alarm / fault*)
- 1x Analog Output (*4 to 20 mA, 0 to 5 V, 0 to 10 V, 1 to 5 V, 2 to 10 V*)
- Digital Output (*Modbus RTU signal*)

Bluetooth communication allows for full instrument configuration, initiation of calibration, bump test and functional test mode, and viewing of status information via the corresponding Bacharach iOS / Android app.

Pre-calibrated sensor exchange modules can be used for maintenance of the instrument instead of performing gas calibration on site.

Non-intrusive magnetic wand can be used to initiate calibration of the device.

2.3.3 MGS-450 Components

This product uses semiconductors which can be damaged by electrostatic discharge (ESD). When handling the PCB, care must be taken so that the electronics are not damaged.

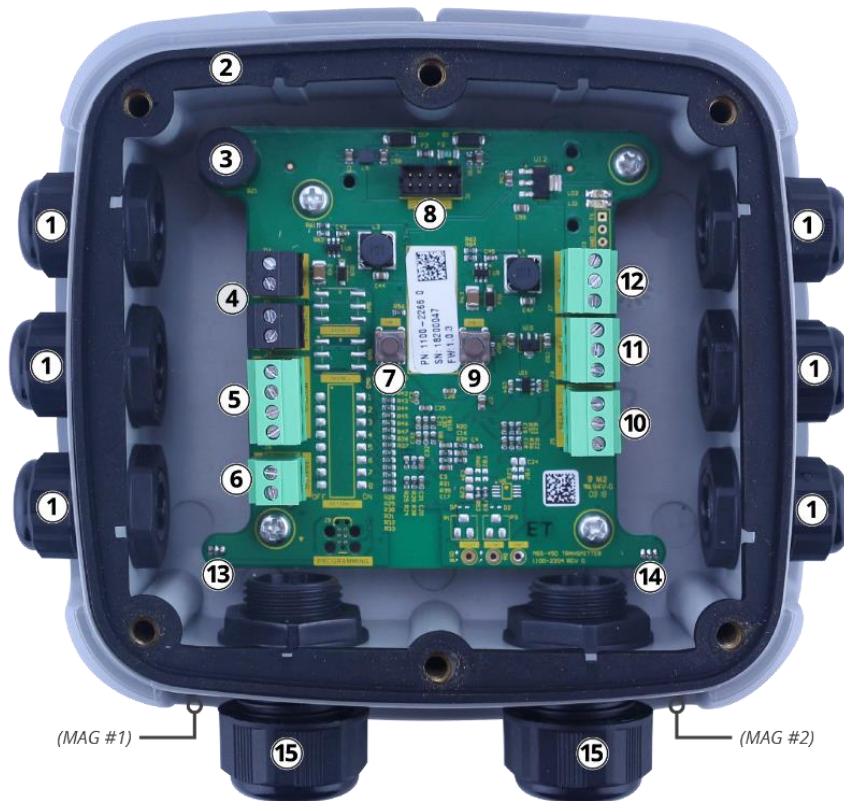

#	Component Description
1	M16 Cable Glands (x6)
2	Rubber Gasket (IP66 Version Only)
3	Internal Alarm Buzzer
4	Power Connections (x2)
5	Digital Connection (<i>Modbus</i>)
6	Analog Connection
7	Tactile Switch #1
8	Ribbon Cable Connection (<i>To Sensor</i>)
9	Tactile Switch #2
10	Relay 3 Connection (<i>FAULT</i>)
11	Relay 2 Connection (<i>HIGH</i>)
12	Relay 1 Connection (<i>LOW</i>)
13	Magnetic Switch #1
14	Magnetic Switch #2
15	M20 Cable Glands (x2)

2.4 MGS-460

2.4.1 MGS-460 Product Overview

The Bacharach MGS-460 continuously monitors indoor or outdoor ambient air for the following gases:

- refrigerants
- oxygen
- toxic and combustible gases.

The instrument may be purchased in the following configuration:

- IP66 with Remote IP66 Sensor, connected via RJ45 cable (*up to 20 meters in length*)

With the integrated Modbus communication, analog output and relays, the instrument can be operated as a stand-alone unit or integrated with Bacharach's MGS-408 8 Channel Modbus Controller. or a third-party device capable of accepting digital and/or analog outputs from the gas detectors, such as a Building Management System (*BMS*) or a Programmable Logic Controller (*PLC*). The instrument is designed to be installed in non-classified, non-hazardous, permanent locations.



2.4.2 MGS-460 Design Features

Transmitter options:

- 2x IP66 rated ABS enclosure connected via RJ45 cable (*up to 5 meters in length*)

Power options

- 24 VAC
- 19.5 to 28.5 VDC

Diagnostic/status LED (*3 color: green, orange and red*)

Configurable output signal options

- 3 x relays (high alarm / low alarm / fault)
- 1x Analog Output (*4 to 20 mA, 0 to 5 V, 0 to 10 V, 1 to 5 V, 2 to 10 V*)
- Digital output Modbus RTU signal

Bluetooth communication allows for full instrument configuration, initiation of calibration, bump test and functional test mode, and viewing of status information via the corresponding Bacharach iOS / Android app.

Pre-calibrated sensor exchange modules can be used for maintenance of the instrument instead of performing gas calibration on site.

Non-intrusive magnetic wand can be used to initiate calibration of the device.

2.4.3 MGS-460 Components

This product uses semiconductors which can be damaged by electrostatic discharge (*ESD*). When handling the PCB, care must be taken so that the electronics are not damaged.

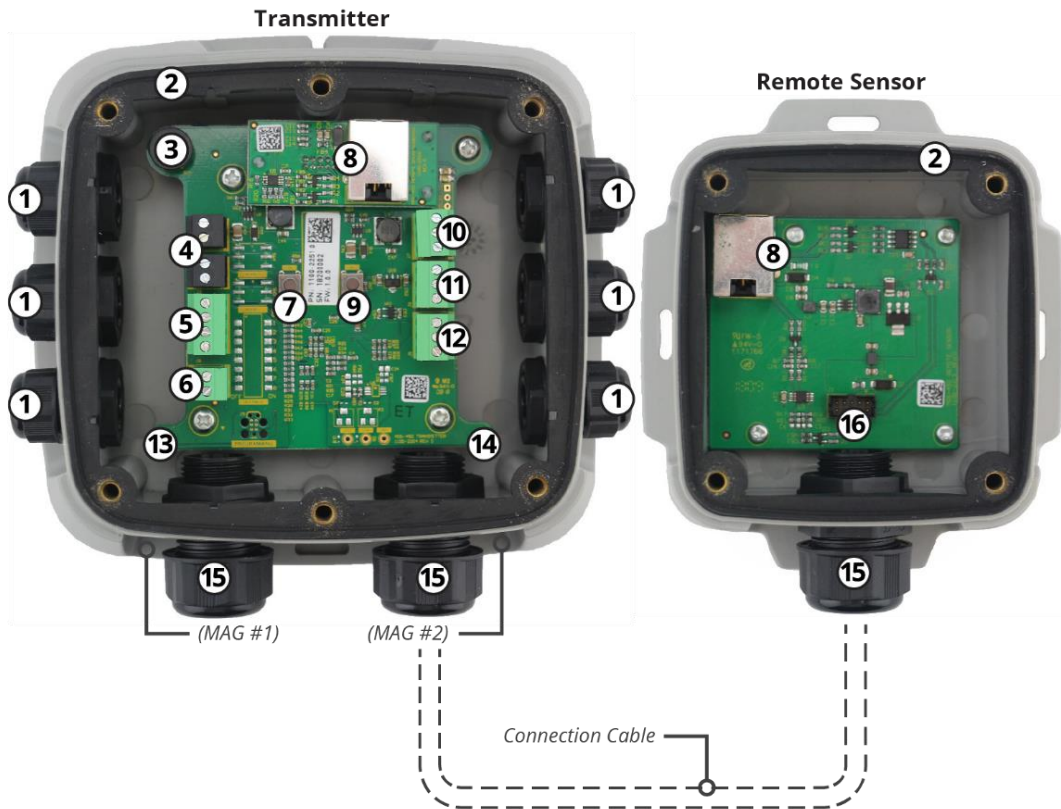

#	Component Description
1	M16 Cable Glands (x6)
2	Rubber Gaskets (x2)
3	Internal Alarm Buzzer
4	Power Connections (x2)
5	Digital Connection (<i>Modbus</i>)
6	Analog Connection
7	Tactile Switch #1

8	Remote Sensor Connections (x2)
9	Tactile Switch #2
10	Relay 3 Connection (<i>FAULT</i>)
11	Relay 2 Connection (<i>HIGH</i>)
12	Relay 1 Connection (<i>LOW</i>)
13	Magnetic Switch #1
14	Magnetic Switch #2
15	M20 Cable Glands (x3)
16	Ribbon Cable Connection (<i>To Sensor</i>)

3. Installation



IMPORTANT: The manufacturer of this product requires that a bump test or calibration be performed following installation to verify instrument functionality.

3.1 General Information

Every detail of installation site selection is critical to ensure overall system performance and effectiveness. Strict compliance and considerable thought must be given to every detail of the installation process, including, but not limited to the following:

- Regulations as well as local, state, and national codes that govern the installation of gas monitoring equipment
- Electrical codes that govern the routing and connection of electrical power and signal cables to gas monitoring equipment
- The full range of environmental conditions to which the instruments will be exposed
- The physical characteristics of the gas or vapor to be detected
- The specifics of the application (*e.g., possible leaks, air movement/draft, etc.*)
- The degree of accessibility required for maintenance purposes
- The types of optional equipment and accessories that will be used with the system
- Any limiting factors or regulations that would affect system performance or installations
- Wiring details, including:
 - The MGS-410 enclosure provides the following cable gland openings:
4x, M16, supports 4-8mm cable outer diameter
 - The MGS-450 enclosure provides the following cable gland openings:
2x, M20, supports 10-14mm cable outer diameter
6x, M16, supports 4-8mm cable outer diameter
 - The MGS-460 enclosure provides the following cable gland openings:
1x, M20, supports 10-14mm cable outer diameter
6x, M16, supports 4-8mm cable outer diameter
 - Secondary circuit must be supplied from an isolating source
 - The wiring for the relays must be selected and fused according to the rated voltages, currents, and environmental conditions
 - If stranded conductors are used, a ferrule should be used
 - To comply with RFI immunity regulations, it is necessary to ground the shield of the communications cable at the PLC, GDA controller, front-end controller, or Building Management System (*e.g., the chassis, the ground bus-bar, etc.*).

3.2 Restrictions

The installation location must have appropriate supply power available for the instrument (i.e., 19.5 to 28.5 VDC or 24 VAC). This ultimately determines the distance the instrument can be mounted from the controller or power supply.

3.3 Mechanical Installation



WARNING: DO NOT allow the lid / sensor to hang from the ribbon cable. Failure to comply may result in damage to the product.

1. Using the provided hardware, securely mount the MGS-400 Gas Detector according to the product dimensions, maximum wiring lengths and following considerations:
 - a. Environment: the full range of environmental conditions when selecting a location.
 - b. Application: the specifics of the application (*possible leaks, air movement / draft, etc.*) when selecting a location.
 - c. Accessibility: the degree of accessibility required for maintenance purposes when selecting a location.
 - d. Target Gas: the specific gravity of the target gas when selecting the height of the instrument.
2. Using a 5/32" (4 mm) hex key / allen wrench (*not included*) remove the lid and disconnect the ribbon cable from the base.
3. Set the lid and rubber gasket (*IP66 version only*) aside to be reinstalled later.

3.4 Electrical Installation

3.4.1 Preparations



IMPORTANT: If analog output is configured for 4 to 20 mA output, ensure that the current loop is connected to a sinking current loop monitor before powering on the instrument. Otherwise, a fault may be displayed indicating an open loop condition. If analog output is unused, ensure it is configured as a voltage output (*default: 1-5V*) to prevent an open loop fault condition. The analog output is designed as sourcing.



CAUTION: Ensure wiring for relays and connections for sensor(s) are made before applying power.



CAUTION: This product uses semiconductors which can be damaged by electrostatic discharge (*ESD*). When handling the printed circuit boards (PCBs), observe proper ESD precautions so that the electronics are not damaged.

3.4.2 Power & Signal Wiring

The product comes with cable glands and plugs pre-installed. The power entry cable gland is without a gland plug. Use the appropriate cable glands to insert and connect the wires for power and signal to the appropriate terminals as indicated in the figure and wiring table that follow. The PCB terminal blocks are pluggable type and may be removed to aid termination.

Polarity must not be reversed.

For 24 VAC installations in a daisy-chain configuration, the neutral polarity must be maintained for all instruments.

Fasten terminal screws.

Connection	Description	Label	Wiring Termination
Power	24 VDC/VAC IN	24V IN: -	24 VDC/VAC neutral / ground
		24V IN: +	24 VAC neutral
	24 VDC/VAC OUT (power daisy chain terminal)	24V OUT: -	24 VDC/VAC neutral / ground
		24V OUT: +	24 VAC neutral
Digital Output	Modbus Network Communications	MODBUS: B	RS-485 "B" (inverted)
		MODBUS: A	RS-485 "A" (non-inverted)
		MODBUS: GND	RS-485 GND
		MODBUS: SH	RS-485 Shield
	Voltage or Current	ANALOG: -	Analog output ground

Analog Output	Output	ANALOG: +	Analog output signal (+)
---------------	--------	-----------	--------------------------

3.4.3 Relay Wiring



WARNING: Relays are rated for 0 to 30V AC/DC. DO NOT apply mains power onto these relays.

Using appropriate cable glands, connect the wires for relay 1, relay 2, and relay 3 to the terminals as indicated in the following wiring table.

Relay	Function
1	Low Alarm
2	High Alarm
3	Fault Alarm

When configured according to the factory default settings, the relays are de-energized during normal operation (not fail-safe). Fail-safe mode can be configured. When configured for fail-safe operation, relays are energized during normal operation. Fail-safe operation ensures relays are triggered in cases of power failure at the instrument. In failsafe operation normally open and normally closed terminals are reversed as indicated by the following table

Terminal	Normal operation	Failsafe Operation
NC	Normally Closed	Normally Open
COM	Common	Common
NO	Normally Open	Normally Closed

3.4.4 Installation of Remote Sensing Head (MGS-460)

Standard RJ45 “Cat 5E STP” Ethernet cables up to 5 meters long may be used with the remote sensor. The cable provided from the factory is 5 meters long.



IMPORTANT: Non standard cable lengths less than 5 meters may be used. Where non standard remote cables are used these must be shielded to comply with EMI regulations.

Remove the bottom right M20 cable gland plug and gland cap, and carefully remove the gland rubber insert. The rubber insert is split to allow it to be installed around the provided RJ45 cable.

Slip the cable gland nut over one end of the terminated RJ45 cable. Apply the split rubber insert onto the cable so that it is between the gland nut and the end of the cable.

Feed the RJ45 connector through a cable gland and into the enclosure, taking care to not damage the PCB.

Reassemble the cable gland by sliding the rubber insert into the gland body and then tightening the gland nut. Confirm that the RJ45 cable is not binding or stressing the PCB terminal blocks (leave no excess cable inside the enclosure).

Plug the RJ45 connector into the provided RJ45 socket.



IMPORTANT: A sensor is automatically recognized and registered by the instrument after a power cycle.

3.4.5 Connecting to MGS-408 Gas Detection Controller

For wiring and configuration information, please refer to the manual which was included with the Bacharach controller (e.g., MGS, GDA, etc.).

- At the central control system, connect the shield of the wires to the earth ground of the controller (e.g., the chassis, the ground bus-bar, etc.).
- For 24 VDC installations, the input is protected. If the polarity is reversed, the instrument will not power-up.
- For 24 VAC installations in daisy-chain, the neutral polarity must be maintained for all instruments (see example below).

3.4.6 Modbus RTU RS-485 Interface

For the Modbus RS-485 network use a 16 to 24 AWG (0.5 to 1 mm²) 3-core, 2 twisted pair + ground, shielded cable with 120 Ω characteristic impedance.

Recommended: Belden 3106A (or equivalent)

The Modbus address, baud rate, stop bit, parity and slave termination is configured through the setup menu. No jumpers or hardware switch settings are required.

Ensure that the communication parameters within the network, including the Building Management System, are configured identically.

To ensure optimal performance of the Modbus network ensure the following guidelines are implemented:

- Ensure instruments are configured in a single bus topology, connecting multiple buses in parallel or branching multiple units from the main bus, may introduce impedance mismatches, reflections and/or signal distortions
- Avoid long stubs when connecting instruments to the bus, stubs should be less than 1 meter in length
- Ensure instruments at end of bus have 120 Ω terminating resistor enabled. Terminating resistors may be enabled via the MGS-400 App (*refer to Section 4.2.3.6 for more information*).
- Ensure A/B signal polarity is maintained throughout RS-485 network
- Connect cable shield drain to physical earth or ground at the controller only.
- Connect cable shield drain to (SH) terminal at instrument
- Ensure cable shield integrity is maintained throughout RS-485 network.
- Do not use shield connection for signal ground. Use cable that provides dedicated ground conductor for signal ground. Connect signal ground to (GND) terminal of instrument.

3.4.7 Conclusion

After all wiring is completed, power the transmitter and confirm operation, and then prepare to seal the enclosure. Note that the IP 41 configurations do not include a sealing gasket.

Align the enclosure gasket (*primary transmitter and remote sensor if equipped*), and then put lid back on and tighten the six screws. Tightening torque should be limited to hand tight, and should be uniform.

4. Operation

4.1 Overview of Normal Operation



WARNING: Before leaving the instrument for normal operation, check the configuration for proper settings and check calibration.

4.1.1 Applying Power & the Start-up Sequence

After applying power, the instrument will go through a start-up sequence (initialization, audible/visual test and self-test sequence). After start-up sequence completes, the instrument will enter a warm-up period to allow the sensor element to stabilize before reporting a valid output.

Step	Description
1.	Switch power on.
2.	Observe start-up sequence and warm-up phase. <ul style="list-style-type: none">Green LED will blink at 0.5 Hz for about 5 minutesModbus flag for warm-up is setBuzzer is offRelay state is “no alarm”Gas reading invalid
3.	Observe normal operation. <ul style="list-style-type: none">Green LED is steady onModbus flag for warm-up is clearedBuzzer is offRelay state is “no alarm”Gas reading valid

4.1.2 Verifying Analog Signals

The MGS-450/460 gas detector features a single configurable analog output. During normal operation the analog output of the instrument is proportional to the detected gas concentration and can be selected from the following.

- 1 to 5 V (Default)
- 0 to 5 V
- 2 to 10 V
- 0 to 10V
- 4 to 20 mA

The MGS-400 Gas Detector uses different voltage/current values to indicate various modes of operation. In normal operation the relative gas concentration output is indicated by the analogue output level. Output level is proportional to the gas level as shown below:

Gas Concentration	1-5V	0-5V	2-10V	0-10V	4-20mA
0%	1V	0V	2V	0V	4 mA
50%	3V	2.5V	6V	5V	12 mA
100%	5V	5V	10V	10V	20 mA

The instrument may also enter several special states, these are indicated by the specific analogue output levels indicated below:

Mode of operation	1-5V	0-5V	2-10V	0-10V	4-20mA
Instrument Fault	≤ 0.3V	N/A	≤ 0.6V	N/A	≤ 1.2 mA
Offline Mode/Maintenance	0.75V	N/A	1.5V	N/A	3 mA
Drift below zero	0.95V	N/A	1.9V	N/A	3.8 mA
Normal operation	1-5V	0-5V	2-10V	0-10V	4-20 mA
Measuring range exceeded	5.12V	5.12V	10.25V	10.25V	20.5 mA
Fault on analog interface	> 5.25V	> 5.25V	> 10.5V	> 10.5V	> 21mA

4.1.3 Verifying the Modbus Signal

















The MGS-400 Gas Detector provides a Modbus RTU digital interface. All status messages and most parameters which can be accessed and/or configured through the Bluetooth® interface can also be accessed and/or configured via a Building Management using a Modbus network.

4.1.4 Status Indication

The MGS-400 gas detectors provide external indication of its current operational state via audible and visual feedback. Visual indication of the instrument status is provided by a single tri-color LED (*Green/Red/Orange*).

MGS-450/460 gas detection instruments also provide relays outputs.

Instrument states and corresponding outputs are shown below:

State	LED	Buzzer	Relay 1 (LOW)	Relay 2 (HIGH)	Relay 3 (Fault)
Warm-up			OFF	OFF	OFF
Normal			OFF	OFF	OFF
Low Alarm			ON	OFF	OFF
High Alarm			ON	ON	OFF
Offline			OFF	OFF	OFF
Fault			OFF	OFF	ON
Negative Gas Fault			OFF	OFF	ON
Zero Cal. Fault			OFF	OFF	OFF
Span Cal. Fault			OFF	OFF	OFF

4.1.5 Switch Functions

User interaction with the MGS-400 gas detector is accomplished through the use of two magnetic switches located on the bottom of each unit. To actuate a magnetic switch, apply the supplied magnetic wand (P/N: 1100-1004) to the relevant switch location as indicated below :

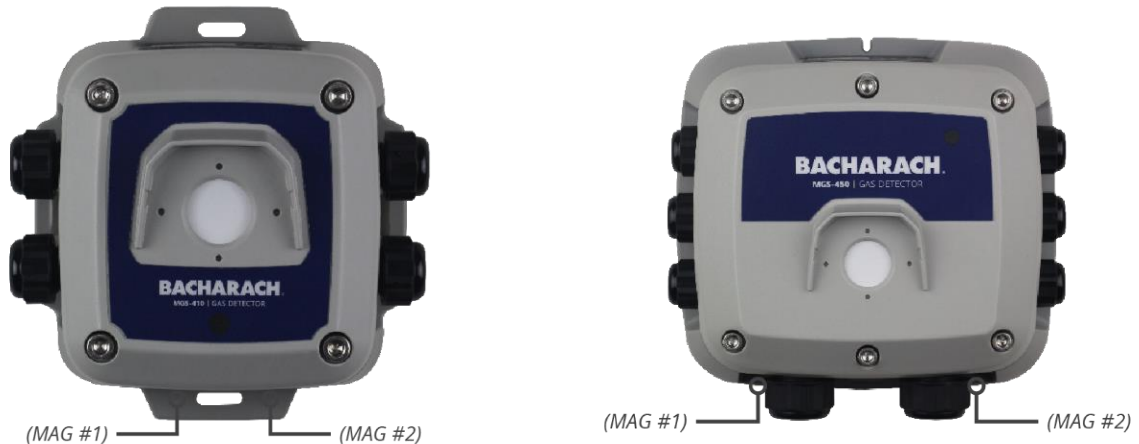

Switch locations above are referred to in this document as MAG#1 and MAG#2.

Depending on the duration the switch is held, a short “TAP” or long “HOLD” will be detected.

To carry out a tap function, tap the relevant switch location for 1s, until a single “chirp” is heard, remove wand to confirm a “TAP”

To carry out a hold function, do not remove the magnetic wand after the first chirp but continue to hold for >5s, until a double “chirp” is heard, remove wand to confirm a “HOLD”

If either switch is held for >30s, a stuck switch fault will be indicated.

To interact with the instrument without use of the magnetic wand, two internal push button tactile switches may be used. Remove lid without removing ribbon cable to access. Internal switches TACT#1 and TACT#2 mirror the functions of MAG#1 and MAG#2.

The function of each switch depends on the current state of the instrument. Refer to the table on the following page for switch functions in each instrument state.

State	Switch 1 Tap	Switch 1 Hold	Switch 2 Tap	Switch 2 Hold
Warm-up	Enable Bluetooth® Connectivity	-	Disable Bluetooth® Connectivity	-
Normal		Start Zero Calibration		Start Span Calibration
Low Alarm		Mute Buzzer		Ack. Latched Alarm
High Alarm		Mute Buzzer		Ack. Latched Alarm
Offline		-		-
Fault		Mute Buzzer		Ack. Latched Fault
Negative Gas Fault		Mute Buzzer		Start Zero Calibration
Zero Cal. Fault		Acknowledge Fault		-
Span Cal. Fault		-		Acknowledge Fault

4.1.6 Reset System to Factory Default Settings

To reset system to factory defaults, remove lid and hold TACT#1 and TACT#2 simultaneously for 30s. Instrument will restart to confirm factory reset.

Alternatively, see section 4.2.3.4 “Reset to factory defaults”, for instructions on resetting instrument configuration via the MGS-400 smartphone app.

4.2 MGS-400 Smartphone Application

To download the MGS-400 Smartphone App, visit www.mybacharach.com/apps.

The companion smartphone application allows users to perform a variety of functions to configure and interact with the MGS-400 gas detector, including:

- View real-time measurements
- Configure instrument
- Test outputs
- Calibrate/Bump test instrument
- Generate customizable calibration certificates

4.2.1 Enable Bluetooth® Connection

1. Enable Bluetooth® discovery by tapping MAG#1 for 1-second. *(After 10-seconds, device will indicate that it is discoverable with audible heartbeat until it has been paired, discovery has timed-out or has been cancelled.)*
2. Launch the MGS-400 App and click the Bluetooth® icon at the bottom of the screen to initiate a scan.
3. Select the instrument from the list of available Bacharach gas detectors.
MGS-410 default alias is “18TMA-DT”
MGS-450/460 default alias is “18TMA”
4. When prompted, enter the passkey (default is “123456”).



WARNING: Default alias, passkey and unlock code can be changed via the MGS-400 App’s configuration menu. Default values should be changed after instrument installation for security purposes.

4.2.2 Checking Status

Current Instrument status can be viewed from the Home tab. Home tab displays the following status information:

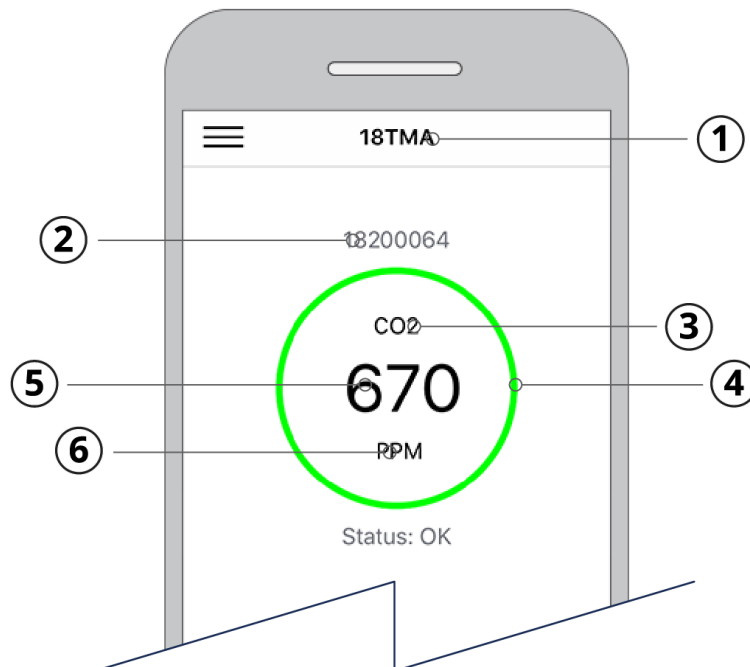

#	Description
1	Alias, user configured instrument name
2	Serial, instrument 8 digit serial number
3	Gas, gas type currently detected by instrument
4	Status ring, provides visual indication of various instrument states (<i>expanded on below</i>)
5	Live Measurement, current measurement in given measurement units
6	Measurement Unit, displayed measurement unit (<i>PPM / PPB / %LEL / %VOL</i>)

State	Status Ring	Description
Warm-up	Green	Gas detector stabilizing after power on or restart
Normal	Green	Normal operation
Low Alarm	Yellow	Gas measurement has exceeded low alarm setpoint
High Alarm	Red	Gas measurement has exceeded high alarm setpoint
Offline	Orange	Gas Detector in maintenance mode and is not actively monitoring gas
Fault	Orange	A fault has been detected
Negative Gas Fault	Orange	Gas detector calibration has drifted below zero, requires zero calibration
Zero Cal. Fault	Orange	Error occurred during zero calibration. Zero calibration has not be updated. Zero calibration required.
Span Cal. Fault	Orange	Error occurred during span calibration. Span calibration has not be updated. Span calibration required.

4.2.3 Instrument Configuration

For security, access to configuration and calibration options are restricted to authorized users only. Access to these functions require use of an unlock code.

To unlock instrument configuration, go to configure tab to setup device. When prompted, enter unlock code to access device configuration. (*The instrument's default code is "1234"*).

Instrument will remain unlocked until Bluetooth® connection has ended.



WARNING: Default alias, passkey and unlock code can be changed via the MGS-400 App's configuration menu. Default values should be changed after instrument installation for security purposes.

4.2.3.1 Change Alias

To allow easy identification of a given instrument, an alias can be assigned to each instrument. This alias is displayed when searching for an instrument via Bluetooth®, on calibration cert and in home tab. To set alias:

- Configure Tab → Alias, Enter required alias for instrument, select OK.
- Instrument must be restarted for change to take effect. Home Tab → Restart, will reboot device.
- Reconnect to instrument to confirm alias has been updated.

4.2.3.2 Change Unlock Code

To prevent unauthorized access to instrument configuration and calibration, default instrument unlock code should be changed during commissioning. To change unlock code:

- Configure Tab → Modbus Unlock Code, enter new 4-digit unlock code for instrument, select OK.
 - Instrument must be restarted for change to take effect. Home Tab → Restart, will reboot device.
 - Reconnect to instrument to confirm unlock code has been updated.
-



IMPORTANT: If custom unlock code is forgotten, unlock code may be reset to default value (1234) by resetting system to factory defaults. Refer to section 4.1.6 for system reset procedure. Note system reset will return all custom system configurations to defaults

4.2.3.3 Change Bluetooth Passcode

To prevent unauthorized access to instrument status, default instrument Bluetooth® passcode code should be changed during commissioning. To change Bluetooth® passcode:

- Configure Tab □ Bluetooth Passcode, enter new 6-digit passcode for instrument, select OK.
- Instrument must be restarted for change to take effect. Home Tab → Restart, will reboot device.
- Reconnect to instrument to confirm unlock code has been updated.



IMPORTANT: If custom passcode is forgotten, unlock code may be reset to default value (123456) by resetting system to factory defaults. Refer to section 4.1.6 for system reset procedure. Note system reset will return all custom system configurations to defaults.

4.2.3.4 Reset to factory defaults

Instrument configuration may be reset to factory defaults via the smartphone application:

- Configure Tab → Reset to factory default, select OK to confirm.
- Instrument will automatically restart and disconnect from smartphone application.



WARNING: Resetting system to factory defaults will remove all custom system configuration including unlock code and Bluetooth passcode. After system reset custom unlock and Bluetooth passcodes should be configured to prevent unauthorized access and reconfiguration of instrument.

4.2.3.5 Alarm Configuration

Low Alarm Setpoint

Value above which a low alarm condition occurs. Low alarm setpoint must be less than the high alarm setpoint and greater than the low alarm limit. The low alarm limit is the fixed minimum limit that is sensor-specific and not editable.

Range of acceptable setpoints is displayed when updating parameter. To update setpoint:

- Configure Tab → Alarm → Low Alarm Setpoint, enter new setpoint, select OK to confirm.



IMPORTANT: In instruments with an oxygen sensor installed, low alarm behavior operates in a depletion mode where gas measurements BELOW the low alarm setpoint initiate a low alarm. This allows monitoring of oxygen displacement and enrichment scenarios.



IMPORTANT: To prevent intermittent alarm operation at the setpoint due to measurement noise this instrument implements hysteresis at the setpoint. Once the alarm level is exceeded, the gas measurement must return a fixed percentage below the alarm threshold before the alarm is disabled. Typical hysteresis value is set at 5% of full scale however this is sensor specific and non-editable.

High alarm Setpoint

Value above which a high alarm condition occurs. High alarm setpoint must be less than the sensor full scale range and greater than the low alarm setpoint.

Range of acceptable setpoints is displayed when updating parameter. To update setpoint:

- Configure Tab → Alarm → High Alarm Setpoint, enter new setpoint, select OK to confirm.
-



IMPORTANT: To prevent intermittent alarm operation at the setpoint due to measurement noise this instrument implements hysteresis at the setpoint. Once the alarm level is exceeded, the gas measurement must return a fixed percentage below the alarm threshold before the alarm is disabled. Typical hysteresis value is set at 5% of full scale however this is sensor specific and non-editable.

Alarm Latching

Enabling alarm latching will maintain alarm or fault condition even after the alarm or fault condition is no longer active. When latched, the alarm or fault condition must be manually acknowledged before the condition will be cleared. This allows transient alarm or fault conditions to be identified.

If an alarm is latched, i.e. the condition has occurred but is no longer active, an acknowledgement button will appear on the home screen. Select this button to acknowledge the latched condition and clear the alarm or fault.

When disabled the alarm or fault status clears automatically as soon as the condition is no longer active. To configure:

- Configure Tab → Alarm → Alarm Latching, select enable/disable, select OK to confirm

4.2.3.6 Modbus Configuration

Address

Sets instrument address for connection to RS-485 Modbus interface. (Default: 1).

To set address:

- Configure Tab → Modbus → Address, select 1-247, select OK to confirm



IMPORTANT: Ensure all instruments on RS-485 bus have been configured with unique node addresses. If two instruments have been configured with same address, bus contention will occur preventing communications with these instruments via the RS-485 interface.

Baud Rate

Sets instrument baud rate for connection to RS-485 Modbus interface. (Default: 9600 baud)

To set baud rate:

- Configure Tab → Modbus → Baud Rate, select 9600/19200, select OK to confirm

Stop Bits

Sets instrument stop bits for connection to RS-485 Modbus interface. (Default: 1 stop bits)

To set number of stop bits:

- Configure Tab → Modbus → Stop Bits, select 1 or 2, select OK to confirm

Parity

Sets instrument parity for connection to RS-485 Modbus interface. (Default: None)

To set parity:

- Configure Tab → Modbus → Parity, select None/Odd/Even, select OK to confirm



IMPORTANT: Stop bits must be set to 1 where parity is Odd or Even

Enable 120Ω Termination

For optimal communication reliability, in RS-485 Modbus networks the last instrument physically connected to the RS-485 bus must include a 120Ω termination resistor. This is to reduce the potential for electrical signal reflection on long buses due to impedance mismatches.

Typically, this requires a physical resistor with the same characteristic impedance of the bus cable to be installed on the bus.

MGS-400 instruments include this termination resistor on all instruments and allow this termination to be enabled via this configuration setting without the need for an external physical resistors.

To enable this termination resistor:

- Configure Tab → Modbus → Enable 120Ω Termination, select enable/disable, select OK to confirm
-



IMPORTANT: Termination resistor should only be enabled on last instrument physically connected to RS-485 bus. An external resistor should not be connected where this is enabled on the instrument.

4.2.3.7 Output Configuration

Analog Output Range

Sets instrument analog output range.

Available ranges: 1-5V (Default), 0-5V, 0-10V, 2-10V, 4-20mA.

To set range:

- Configure Tab → Outputs → Analog Output Range, select desired range, select OK to confirm

Buzzer

Enable or disable buzzer. Buzzer provides local audible alarm/fault indication. Buzzer is enabled by default.

To enable/disable buzzer:

- Configure Tab → Outputs → Buzzer, select enable/disable, select OK to confirm

Relay Failsafe

Enable or disable Relay Failsafe operation. When configured for fail-safe operation, relays are energized during normal operation. Fail-safe operation ensures relays are triggered in cases of power failure at the instrument. In failsafe operation normally open and normally closed terminals are reversed as indicated in Section 3.4.3.

Relays are configured as non-failsafe by default.

To enable/disable relay failsafe:

- Configure Tab → Outputs → Relay Failsafe, select enable/disable, select OK to confirm

Alarm Delay

Sets delay in minutes before instrument will indicate an alarm condition after low or high alarm threshold has been exceeded. May be used to prevent short transient alarm conditions from activating alarms. Alarm delays may be set for 0-15 minutes. Alarm delay is configured as 0 minutes by default.

To set alarm delay:

- Configure Tab → Outputs → Alarm Delay, enter desired delay in minutes (0-15), select OK to confirm.

Analog Zero Adjust

Analog zero adjust applies a fixed offset to the analog output. This allows removal of small errors in the output between the gas detection instrument and the measurement at the controller due to cable resistance when using voltage outputs.



NOTE: MGS-408 controller uses digital interface, this analog adjustment is only required where using third party controller using analog interface for gas concentration and status monitoring.

To apply adjustment ensure instrument is outputting fixed voltage (default 1V at zero ppm or use output test function to set specific voltage value), monitor remote measurement and adjust zero offset until remote measurement matches expected voltage output.

Adjustment is limited to $\pm 10\%$ full scale

To set analog zero adjustment:

- Configure Tab → Outputs → Analog Zero Adjust, use slider to set desired offset adjustment.
- Alternatively, tap “Analog Zero Adjust (X.X%)” text and enter specific offset required (-10 to 10)

Analog Span Range

Analog span range scales the FSD (full-scale deflection) of the analog output. The selected range determines the equivalent gas measurement at the analog output maximum range.

Example: R134A 1000 ppm, 0-5V analog output. If Analog Span Range is set to 20%, the full analog output range only covers the first 20% of the gas measurement range, i.e 0-200 ppm will output 0-5V, above 200 ppm the output will be truncated to 5V.

Note, sensor resolution stays at the value for the max range.

Adjustment is limited to between 20%-100% FSD, Default is set to 100%.

To set analog span range:

- Configure Tab → Outputs → Analog Span Range, use slider to set desired range
- Alternatively, tap “Analog Span Range (X.X%)” text and enter specific range required.

5. Care & Maintenance

5.1 Maintenance Intervals

Interval	Function
During Commissioning	Check calibration.
	Check LEDs for proper operation.*
	Check for proper buzzer and relay operation.*
	Check signal transmission to the BMS/BAS (central controller) if connected.*
Every 6-12 Months**	Inspection by trained service personnel.
	Check LEDs for proper operation.*
	Check for proper buzzer and relay operation.*
	Check signal transmission to the BMS/BAS (central controller) if connected.*
	Calibrate the sensor or contact Bacharach for sensor exchange with factory- calibrated sensor.
As Required	Replace sensor module(s)

* These can be activated via Modbus commands or via the MGS-400 smartphone application.

** Typical maintenance frequency can vary by sensor type.

Sensor Type	Recommended Maintenance Interval	Typical Sensor Lifetime
Electrochemical*	12 months	2-3 years
Catalytic Bead	Zero calibration - 1-3 months Span calibration - 6 months	5-7 years
Semiconductor*	6 months after commissioning 12 months thereafter	4-6 years
Infrared	12 months	5-7 years

* Sensors should be checked after exposure to significant concentrations of gas, which can shorten the sensor lifetime and/or reduce its sensitivity.

5.2 Adjustments

5.2.1 Introduction

Adjustment of the detector must be performed at regular intervals as required by national standards or regulations (e.g., EN 378, ASHRAE 15, BREEAM, etc.).

Breathing Hazard: Calibration gas MUST NOT be inhaled! See appropriate Safety Data Sheets. Calibration gas should be vented into a fume hood or to the outside of the building.

Zero First, Then Span: For proper operation, never adjust the span *before* completing a zero adjustment. Performing these operations out of order will cause faulty calibration.



IMPORTANT: Bacharach recommends calibrating detectors within the application-specific condition and with target gas. This method of zeroing the detector in the application environment and performing a target gas calibration is more accurate. A surrogate gas calibration may only be performed as an alternative if a target gas calibration is not possible.



IMPORTANT: The sensor should be fully stabilized (*at least 2 hours, preferably 24 hours*).



IMPORTANT: When entering the functions for zero or span adjustment, the detector will automatically enter OFFLINE mode, and will remain OFFLINE until either the OFFLINE mode is canceled by tapping the respective magnetic switch, or the OFFLINE mode times out within 6 minutes (*typical*) after the adjustment has ended.

5.2.2 General Calibration Procedure



WARNING: The MGS-400 Gas Detector MAY NOT be in an alarm or fault condition during calibration. Acknowledge any alarms or faults BEFORE attempting to begin the calibration process.



WARNING: Except for CO₂ or O₂ sensors, calibration gas must be in a balance of air, not nitrogen (N₂).



IMPORTANT: Calibration and / or bump testing requires the MGS-400 calibration adapter kit (P/N: 6302-9990).



IMPORTANT: At elevations higher than 6,560' (2,000 m), calibration will result in a lower reading. Above 6,560', the instrument should be calibrated in the environment of operation.

1. Fit calibration adapter to the gas detector lid.
2. If using a variable flow regulator, adjust the gas flow to approximately 0.3 L/min.

5.2.3 Zero Adjustment

Ambient air can be used to zero the sensor instead of synthetic air only if the area is known to be free of the target gas or any gas to which the sensor may be cross-sensitive. In this case, no cylinder or calibration adapter is needed for the zero adjustment.



WARNING: The MGS-450 MAY NOT be in an alarm or fault condition during calibration. Acknowledge any alarms or faults BEFORE attempting to begin the calibration process.



WARNING: Except for CO₂ or O₂ sensors, ambient air may be used instead of zero gas if the area is known to be free of the target gas or any gases to which the sensor may be cross-sensitive.



IMPORTANT: Calibration and / or bump testing requires the MGS-400 calibration adapter kit (P/N: 6302-9990).

-
1. Begin zero adjustment:
 - a. MGS-400 App: Home Tab → Calibrate → scan barcode on gas cylinder or manually enter values for zero gas.
 - b. Manual: hold MAG#1 for >5-seconds. The LED will blink green-green-red when the instrument is ready.
 2. Apply zero gas (*or ambient air per warning above*).
 3. Confirm the start of calibration:
 - a. MGS-400 App: press the Start Zero button.
 - b. Manual: tap MAG#1 within 30-seconds or the instrument will time-out and return to normal operation.
 4. Complete zero adjustment:
 - a. MGS-400 App: app will countdown to completion. If calibration is successful, proceed to Step 5. If calibration is unsuccessful, return to the Home screen and press the Acknowledge button to clear the zero calibration fault.
 - b. Manual: the LED will blink green-red, green-red-red, green-red-red-red, etc. until calibration is complete. To abort, hold MAG#1 for >5-seconds, turn off gas flow and remove the calibration adapter. If calibration is successful (*green LED*), proceed to Step 5. If calibration is unsuccessful (*LED blinks orange @ 2 Hz*), tap MAG#1 to discard the calibration attempt.
 5. Turn off gas flow from zero gas.
 6. Replace zero gas with calibration gas in preparation for span adjustment.

5.2.4 Span Adjustment



WARNING: Except for CO₂ or O₂ sensors, calibration gas must be in a balance of air, not nitrogen (N₂).



IMPORTANT: At elevations higher than 6,560' (2,000 m), calibration will result in a lower reading. Above 6,560', the instrument should be calibrated in the environment of operation.

1. Begin span adjustment:
 - a. MGS-400 App: scan barcode on gas cylinder or manually enter values for calibration gas.
 - b. Manual: hold MAG#2 for >5-seconds. The LED will blink green-green-orange when the instrument is ready.
2. Apply calibration gas at the concentration listed on the calibration gas concentration label (*located on top of the instrument*).
 - Part Number
 - Serial Number
 - Sensor Type
 - Maximum Range
3. Confirm the start of calibration:
 - a. MGS-400 App: press the Start Span button.
 - b. Manual: tap MAG#2 within 30-seconds or the instrument will time-out and return to normal operation.
4. Complete span adjustment:
 - a. MGS-400 App: app will countdown to completion. If calibration is successful, proceed to Step 5. If calibration is unsuccessful, return to the Home screen and press the Acknowledge button to clear the span calibration fault.
 - b. Manual: the LED will blink green-orange, green-orange-orange, green-orange-orange-orange, etc. until calibration is complete. To abort, hold MAG#2 for >5-seconds, turn off gas flow and remove the calibration adapter. If calibration is successful (*LED blinks green-orange-red*), proceed to Step 5. If calibration is unsuccessful (*LED blinks orange @ 2 Hz*), tap MAG#2 to discard the calibration attempt.
5. Turn off gas flow from calibration gas and remove the calibration adapter.
6. Allow sensor to recover / stabilize before the instrument returns to normal operation (*green LED*).

5.2.5 System Bump Test

A bump test is a live test of the system to verify that the detector responds to gas and all connected alarm devices, BMS, etc. are operating accordingly. It is recommended that all involved persons are informed about the test and certain alarms might have to be inhibited (*e.g., shutdown valves, notification of authorities, etc.*).



IMPORTANT: The manufacturer of this product requires that a bump test or calibration be performed following installation to verify instrument functionality.

1. Connect adapter and gas cylinder according to the instructions in the General Calibration Procedure.
2. If desired, disable / silence external annunciators (*e.g., shutdown valves, notification of authorities, etc.*):
 - a. MGS-400 App: Home Tab → Calibrate → Bump → toggle TAKE OFFLINE to disable communications to external devices.
 - b. Manual: Inform building personnel of test so that external devices can be disabled / silenced.
3. Apply a sufficiently high concentration of the target gas to trigger alarms, but NOT pure refrigerant or hydrocarbons (*e.g., do not use a butane lighter*).
4. Once thresholds have been exceeded, relays should activate, digital outputs should transmit the gas concentration and:
 - a. MGS-400 App: gas concentration should be displayed, the instrument status should be “LOW ALARM” or “HIGH ALARM” and alarms states should be “ON.”
 - b. Manual: LED status should display “LOW ALARM” or “HIGH ALARM.”
5. Turn off gas flow and remove the calibration adapter.
6. Allow sensor to recover / stabilize before the instrument returns to normal operation (*green LED*).

5.3 Troubleshooting

5.3.1 Hexadecimal Format

All fault codes can be retrieved through the Modbus interface and are shown in hexadecimal (*hex*) format. A hex digit can represent multiple codes as shown below.

Hex Code	Equivalent Error Code(s)	Hex Code	Equivalent Error Code(s)	Hex Code	Equivalent Error Code(s)	Hex Code	Equivalent Error Code(s)
0	0	4	4	8	8	C	4 + 8
1	1	5	1 + 4	9	1 + 8	D	1 + 4 + 8
2	2	6	1 + 2 + 3	A	2 + 8	E	2 + 4 + 8
3	1 + 2	7	1 + 2 + 4	B	1 + 2 + 8	F	1 + 2 + 4 + 8

5.3.3 Fault Codes



NOTICE: If a sensor fault occurs during a gas alarm condition, then the fault overrides the alarm condition.

Sensor faults may be decoded using the following table. Note that several faults may be reported at the same time. For example, fault code “00000003” is a combination of fault codes 00000001 (*No sensor signal*) and 00000002 (*Voltage out of specification 1V*).



NOTICE: If a “last fault” attribute indicates that a fault has occurred at some point in time, but the corresponding “current fault” attribute shows no fault, then the problem has self-healed and no service action is required.

Fault Bit	System Fault	Possible Causes	Required Action(s)
0x00000001	Software fault	Firmware error (e.g. unexpected state)	Power-cycle. If it re-occurs then call service
0x00000002	Voltage out of specification 1V	Voltage rail out of range	Call service
0x00000004	Voltage out of specification 3.3V	Voltage rail out of range	Call service
0x00000008	Voltage out of specification 5V	Voltage rail out of range	Call service
0x00000010	Voltage out of specification 5.4V	Voltage rail out of range	Call service
0x00000020	Voltage out of specification 12V	Voltage rail out of range	Call service
0x00000040	Voltage out of specification VIN	Voltage rail out of range	Call service
0x00000080	System Flash Memory Read Fault	Error reading from internal Flash	Power-cycle. If it re-occurs then call service
0x00000100	System Flash Memory Write Fault	Error writing to internal Flash	Power-cycle. If it re-occurs then call service
0x00000200	System Flash Memory CRC fault	Error in internal Flash CRC	Power-cycle. If it re-occurs then call service
0x00000400	System Invalid Configuration	Error in system configuration	Power-cycle. If it re-occurs then call service
0x00000800	GPIO fault	Error detected on GPIO pin	Call service
0x00001000	Modbus Fault	Error detected in Modbus Communications	Power-cycle. If it re-occurs then call service
0x00002000	Analog Output Fault (MGS-450 Only)	Error updating DAC value	Power-cycle. If it re-occurs then call service
0x00004000	Bluetooth Fault	Error detected in Bluetooth module	Power-cycle. If it re-occurs then call service
0x00008000	Stuck switch	Magnetic and/or Tactile switch activated for > 1 minute	Call service
0x00010000	Sensor Element Out	Cannot detect sensor element	Check sensor connection
0x00020000	Sensor Element Fault	Fault detected in sensor element	Replace Sensor Module
0x00040000	Sensor ADC Sensor Read Fault	Cannot read from sensor ADC	Check sensor connection/Replace Sensor Module
0x00080000	Sensor ADC Current Read Fault	Cannot read from current ADC	Check sensor connection/Replace Sensor Module
0x00100000	Sensor AFE Read Fault (EC only)	Cannot read from EC sensor AFE	Check sensor connection/Replace Sensor Module
0x00200000	Sensor AFE Write Fault (EC only)	Cannot write to EC sensor AFE	Check sensor connection/Replace Sensor Module
0x00400000	Sensor AFE Status Fault (EC only)	Error in EC sensor AFE	Check sensor connection/Replace Sensor Module

0x00800000	Sensor EEPROM Read Fault	Error in reading from sensor EEPROM	Power-cycle/Check sensor connection/Replace Sensor Module
0x01000000	Sensor EEPROM Write Fault	Error in writing to sensor EEPROM	Call service
0x02000000	Sensor EEPROM CRC Fault	Error in CRC from sensor EEPROM	Power-cycle/Replace Sensor Module
0x04000000	Sensor EEPROM Configuration Fault	Error in sensor EEPROM data	Replace Sensor Module
0x08000000	Sensor UART Read Fault	Cannot read from sensor UART	Check sensor connection/Replace Sensor Module
0x10000000	Sensor Temperature Fault	Temperature cannot be read or is out of specification	Ensure Sensor is operating within specified temperature range/Check sensor connections
0x20000000	Negative Gas Concentration Fault	Sensor output has drifted too negative	Initiate Zero calibration (Via App/Hold MAG#2)
0x40000000	Zero Calibration failure	Zero calibration failed	Acknowledge failed calibration (Via App/Hold MAG#1)
0x80000000	Span Calibration failure	Span calibration failed	Acknowledge failed calibration (Via App/Hold MAG#2)

5.4 Sensor Maintenance



CAUTION: This product uses semiconductors which can be damaged by electrostatic discharge (*ESD*). When handling the PCB, care must be taken so that the electronics is not damaged.

5.4.1 Components Overview

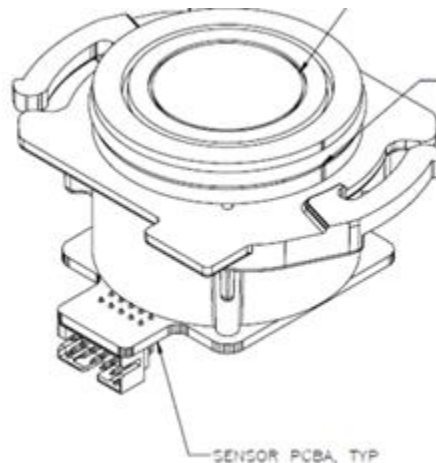

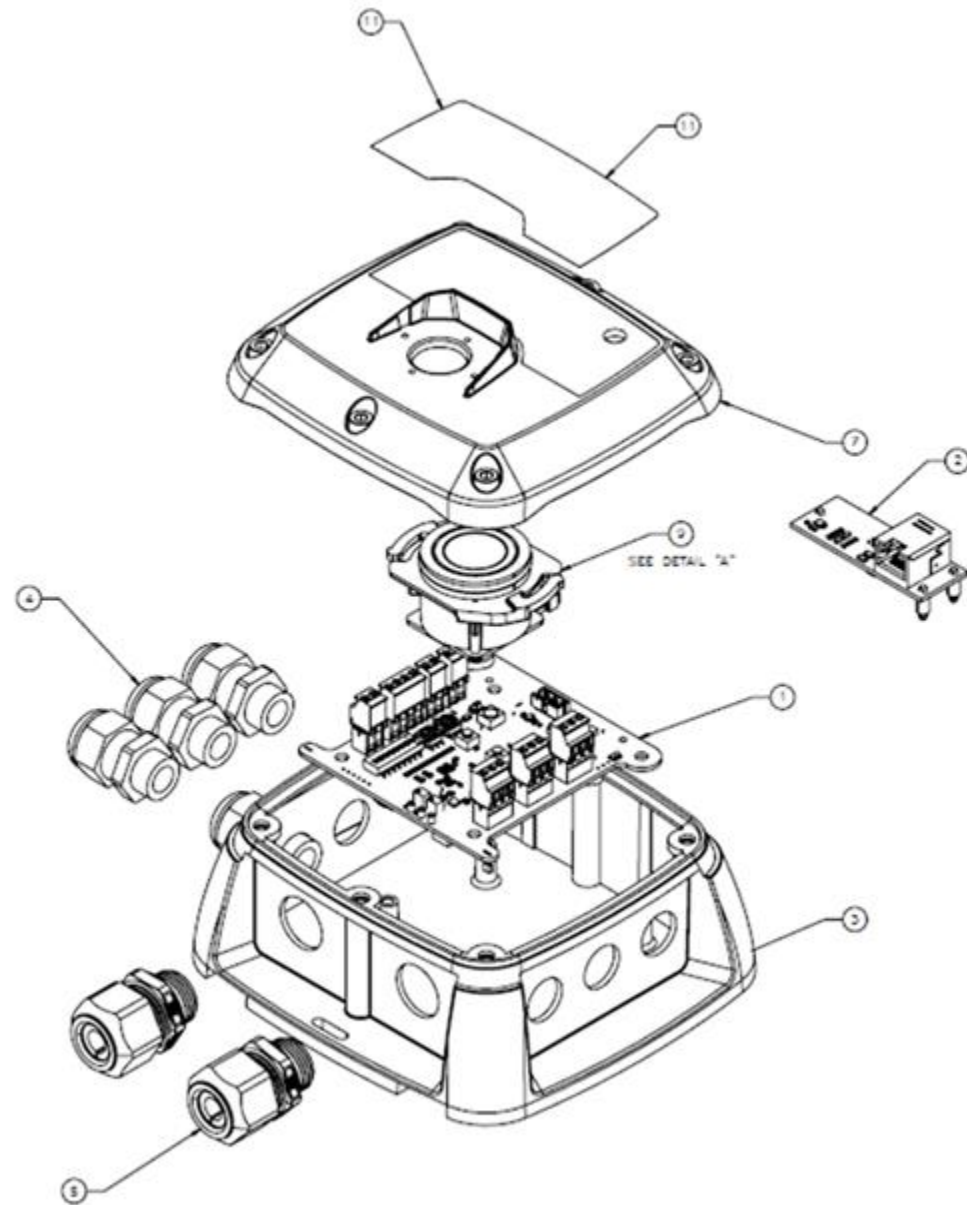

IP66 Product arrangement shown for reference; Remote Daughterboard PCB shown (*used for Remote IP66 Sensor Configurations*). Note: Cable Glands and labeling are factory installed.

5.4.2 Replacing the Sensor Module



CAUTION: This product uses semiconductors which can be damaged by electrostatic discharge (*ESD*). When handling the PCB, care must be taken so that the electronics is not damaged.

To replace the gas detector's sensor module:

1. Power-down the gas detector.
2. Using a 5/32" (4mm) hex key / allen wrench (*not included*), remove the lid and disconnect the ribbon cable from the sensor module.
3. Remove installed sensor module from lid by holding onto the housing and turning counter-clockwise 90°. Take care not to apply excessive force to the sensor module's circuit board. When the square tab of the sensor housing is aligned with the lock icon, firmly pull the module to remove it from the housing.
4. Install the new sensor module by aligning the square tab with the lock icon before firmly pressing it into the enclosure. Taking care not to apply excessive force to the sensor module's circuit board, rotate the sensor module clockwise 90° (*or until the triangle icon aligns with the lock icon on the lid*).
5. Connect the ribbon cable (*to the sensor module and transmitter*) and close the lid.
6. Ensure gasket is aligned correctly (*IP66 versions only*) and tighten the lid using the supplied hardware in an "X" pattern. Tightening torque should be limited to hand tight and should be uniform.
7. Power-up the gas detector.
8. After start-up sequence has finished, check sensor response (*bump test*).

5.5 Cleaning the Instrument

Clean the detector with a soft cloth using water and a mild detergent. Rinse with water. Do not use any alcohols, cleaning agents, sprays, polishes, detergents, etc.

6. Additional Information

6.1 Sensor Principle

6.1.1 Electrochemical Sensors

Electrochemical sensors measure the partial pressure of gases under atmospheric conditions. The monitored ambient air diffuses through a membrane into the liquid electrolyte in the sensor. The electrolyte contains a measuring electrode, a counter-electrode and a reference electrode. An electronic “potentiostat” circuit ensures a constant electrical voltage between measuring electrode and reference electrode. Voltage, electrolyte, and electrode material are selected to suit the gas being monitored so that it is transformed electrochemically on the measuring electrode and a current flows through the sensor. This current is proportional to the gas concentration. At the same time, oxygen from the ambient air reacts at the counter electrode electrochemically. The current flowing through the sensor is amplified electronically, digitized and corrected for several parameters (e.g., the ambient temperature).

6.1.2 Catalytic Bead Sensors

A catalytic bead sensor measures the partial pressure of combustible gases and vapors in ambient air. It uses the heat-of-combustion principle.

The monitored air diffuses through the sintered metal disc into the sensor. The mixture of combustible gases, vapors, and air are catalytically combusted at a heated detector element (called a *pellistor*). The oxygen content in the air must be greater than 12 Vol%. Due to the resulting heat-of-combustion, the temperature of the detector element rises. This increase in temperature causes a change of resistance in the detector element, which is proportional to the concentration of the mixture of combustible gases and vapors in the monitored air. In addition to the catalytically active detector element, there is a compensator element. Both elements are parts of a Wheatstone bridge. Thus environmental effects like changes in ambient temperature or humidity are almost entirely compensated.



IMPORTANT: Certain substances in the atmosphere to be monitored may impair the sensitivity of the sensors. Such substances include, but are not limited to:

1. Polymerizing substances such as acrylonitrile, butadiene and styrene,
2. Corrosive compounds such as halogenated hydrocarbons (releasing halogens such as bromine, chlorine or fluorine when oxidized) and halogen hydride acids as well as acidic gaseous compounds such as sulfur dioxide and nitrogen oxides, Catalyst poisons such as sulfurous and phosphorous compounds, silicon compounds (especially silicones), and metal-organic vapors.

It may be necessary to check the calibration if the sensor has been exposed for a long time to a high concentration of flammable gases, vapors, or the above-mentioned contaminating substances.

The nature of catalytic bead sensor technology means that sensor drift may typically be up to $\pm 5\%$ LEL per month. Instruments using these sensors should be zeroed regularly following the instructions in section 5 of this manual.

6.1.3 Semiconductor Sensors

Semiconductor or metallic oxide sensors (*MOSs*) are among the most versatile of all broad-range sensors. They can be used to detect a variety of gases and vapors in low ppm or even combustible ranges. The sensor is made up of a mixture of metallic oxides. They are heated to a temperature between 150° and 300° C depending on the gas(es) to be detected. The temperature of operation as well as the “recipe” of mixed oxides determines the sensor selectivity to various toxic gases, vapors, and refrigerants. Electrical conductivity greatly increases as soon as a diffusion process allows the gas or vapor molecules to come in contact with the sensor surface. Water vapor, high ambient humidity, temperature fluctuations, and low oxygen levels can result in higher readings.



IMPORTANT: Certain substances in the environment to be monitored may impair the sensitivity of the sensors:

- 1 Materials containing silicone or silicone rubber/putty
- 2 Corrosive gases such as hydrogen sulfide, sulfur oxide, chlorine, hydrogen chloride, etc.
- 3 Alkaline metals, salt water spray.

6.1.4 Infrared Sensors

The infrared (IR) gas sensor is designed to measure the concentration of combustible gases and vapors in the ambient air. The sensor principle is based on the concentration-dependent absorption of infrared radiation in measured gases.

The monitored ambient air diffuses through a sintered metal material into the enclosure of an optical “bench”. The broadband light emitted by an IR source passes through the gas in the optical bench and is reflected by the walls from where it is directed towards a dual-element detector. One channel of the detector measures the gas-dependent light transmission, while the other channel is used as a reference. The ratio between measurement and reference signal is used to determine the gas concentration. Internal electronics and software calculate the concentration and produce an output signal.

6.2 Disposing of the Instrument

6.2.1 Disposing of the Electrical & Electronic Equipment

EU-wide regulations governing the disposal of electrical and electronic appliances which have been defined in the EU Directive 2012/19/EU and in national laws have been effective since August 2012 and apply to this device.

Common household appliances can be disposed of using special collecting and recycling facilities. However, this device has not been registered for household usage. Therefore it must not be disposed of through these channels. The device can be returned to your national Bacharach Sales Organization for disposal. Please do not hesitate to contact Bacharach if you have any further questions on this issue.

6.2.2 Disposing of Sensors

Dispose of sensors in accordance with local laws.



DANGER: Do not dispose of sensors in fire due to the risk of explosion and resulting chemical burns.



WARNING: Do not force open electrochemical sensors.



WARNING: Observe the applicable local waste disposal regulations. For information, consult your local environmental agency, local government offices or appropriate waste disposal companies.

6.3 Technical Specifications

6.3.1 General Specifications

Category		Specifications
Signals to Central Controller	Analog Current	Normal operation:..... 4 to 20 mA
		Drift below zero:..... 3.8 mA
		Measuring range exceeded:..... 20.5 mA
		Instrument fault:..... ≤ 1.2 mA
		Fault on analog interface:..... > 21 mA
		Offline mode/Maintenance signal:..... 3 mA steady signal
	Analog Voltage	0 to 5 V; 1 to 5 V; 0 to 10 V; 2 to 10 V (selectable) During fault condition, 1 to 5 V and 2 to 10 V outputs are 0 V.
	Modbus RTU over RS-485	Baud rate:..... 9,600 or 19,200 (selectable)
		Start bits:..... 1
		Data bits:..... 8
		Parity:..... None, odd, even (selectable)
		Stop bits:..... 1 or 2 (selectable)
		Retry time:..... 500 ms, min time between retries
End of message:..... Silent 3.5 characters		

Power Supply and Relays	Operating voltage	19.5 to 28.5 VDC; 24 VAC \pm 20%, 50/60 Hz
	Inrush current	1.5 A
	Operating current, max.	MGS-410: 2W, 85mA @ 24VDC MGS-450/60: 4W, 170mA @ 24VDC
	Relay rating	3 SPDT 1 A at 24 VAC/VDC, resistive load
	Audible alarm	Internal Buzzer \geq 72 dB at 4" (10 cm)
	Alarm delay	0 to 15 minutes (<i>selectable</i>)
Wiring	Power and analog signal	2-core shielded cable, 16 to 20 AWG (0.5 to 1.5 mm ²)
	Modbus network	3-core, 2 twisted pair + ground, shielded cable with 120 Ω characteristic impedance, 16 to 24 AWG (0.5 to 1.5 mm ²).
	Cable gland	M20, 10-14mm cable outer diameter M16, 4-8mm cable outer diameter
Physical Specifications	Enclosure protection	IP41 / IP66
	Enclosure Size (WxHxD) (Approx.)	MGS-410: 5.1x5.1x2.7" (130x130x68 mm) MGS-450 IP41: 6.5x 6.5x3.0" (165x165x77 mm) MGS-450 IP66: 6.5x6.5x3.4" (165x165x87 mm) MGS-460: 6.5x6.5x3.4" (165x165x87 mm) MGS-460 Remote: 4.5x 5.4x2.7" (115x136x68 mm)
	Weight (Approx.)	MGS-410: 9.2oz (260 g) MGS-450: 1lb, 1oz (480 g) MGS-460: 1lb, 11.7oz (758 g)
Environmental	Temperature	- 40 to 120 °F (-40 to 50 °C)
	Storage temperature	- 5 to 100 °F (-20 to 40 °C)
	Humidity	5 to 90 %RH, non-condensing (15 to 90 %RH, non-condensing, EC sensors excl. O ₂)
	Pressure	23.6 to 32.5 inch Hg / 800 to 1,100 mbar

	Elevation	0 to 10,000 ft. (3,050 m) altitude
	Sensors	See Section 6.3.2 for sensor specifications.
	Influences	For influences on the measurement performance and restrictions of a particular sensor see sensor data sheet.
Agency Approvals	CE, EN 50270:2015, UL/CSA/IEC/EN 61010-1	
Company Certifications		

6.3.2 Sensor Specifications

Sensor Information	Electro-Chemical (EC)	Semi-Conductor (SC)	Catalytic Bead (CAT)	Infrared (IR)
Sensor Life (Typical)	2 to 3 years	5 to 8 years	5 years	5 years
Temperature Range	<ul style="list-style-type: none"> NH₃ 100 / 1,000 ppm: -40 to 40° C NH₃ 5,000 ppm: -20 to 40° C CO 500 ppm: -40 to 50° C NO₂ 20 ppm: -20 to 40° C O₂ 30% Volume: -20 to 50° C 	-40° to 50° C	-40° to 50° C	-40° to 50° C
	<ul style="list-style-type: none"> NH₃ 100 / 1,000 ppm: -40 to 104° F NH₃ 5,000 ppm: -4 to 104° F CO 500 ppm: -40 to 122° F NO₂ 20 ppm: -4 to 104° F O₂ 30% Volume: -4 to 50° F 	-40° to 122° F	-40° to 122° F	-40° to 122° F

EC Sensors	Formula	Measuring Range(s)
Ammonia	NH ₃	0 to 100, 0 to 1,000, 0 to 5,000 ppm
Carbon Monoxide	CO	0 to 1,000 ppm
Nitrogen Dioxide	NO ₂	0 to 20 ppm
Oxygen	O ₂	0 to 30 Vol%

6.4 Modbus Registers



IMPORTANT: If items span two registers (e.g., 1005 and 1006), then the registers are “long” or “float” data types. Otherwise, the registers are integer data types or ASCII.

6.4.1 Integration - Dynamic Sensor Data

Input Register (*Function 04 Read*)

1094	Signed Raw Gas Concentration (PPM/PPB/VOL/LEL)	Signed Raw Gas Concentration PPM or % VOL or % LEL - no thresholding; used for zero-calibration to see negative values	32-bit signed Integer
1095			
1096	Signed Raw Gas Concentration (PPM)	Signed Raw Gas Concentration PPM or % VOL or % LEL - no thresholding; used for zero-calibration to see negative values	32-bit float
1097			
1098	Sensor Uptime	Hours since last restart	16-bit unsigned Integer
1099	Offline Mode Status	Offline mode status	16-bit unsigned Integer
1100	Concentration % FS (0-100)	Gas concentration in % full-scale	16-bit unsigned Integer
1101	Concentration (PPM/PPB/VOL/LEL)	Concentration in display units	16-bit unsigned Integer
1102	Concentration PPM	Signed Raw Gas Concentration PPM or % VOL or % LEL - no thresholding; used for zero-calibration to see negative values	32-bit signed Integer
1103			
1104	Sensor Burning Hours	Hours since last calibration	16-bit unsigned Integer

1105	PPM Hours	Accumulated PPM Hours since sensor manufacture (100ppm for 2 hours = 200ppm hours)	32-bit unsigned Integer
1106			
1107	Temperature (°C)	Current sensor temperature sensor reading (°C)	16-bit signed Integer
1108	Fault Code	Bit packed sensor fault flags currently active (see faults sheet for details of flags)	32-bit unsigned Integer
1109			
1110	Last Sensor Fault Code	Sticky faults as above but fault bits remain set after clearing to catch transient faults	16-bit unsigned Integer
1111	Last System Fault Code	Sticky faults as above but fault bits remain set after clearing to catch transient faults	16-bit unsigned Integer
1112	Calibration Expired Flag	Calibration expired flag, when set sensor needs recalibration	Boolean
1113	Sensor Startup Flag	Set if sensor is still in warm-up stabilization period	Boolean
1114	Low Alarm Flag	Set if low alarm is active	Boolean
1115	High Alarm Flag	Set if high alarm is active	Boolean
1116	Fault Flag	Set if any fault flag is active	Boolean
1117	Sensor Saturation Flag	Set if gas concentration exceeds full-scale range	Boolean
1118	Sensor Underflow Flag	Set if gas concentration falls below zero	Boolean
1119	Auto Cal Zero Time Remaining	Seconds remaining in auto zero calibration procedure	Unsigned Integer
1120	Auto Cal Span Time Remaining	Seconds remaining in auto span calibration procedure	Unsigned Integer
1121	Auto Cal Recovery Time Remaining	Seconds remaining in span recovery	Unsigned Integer
1122	Maximum Temperature Reported (°C)	Maximum Temperature reported by sensor Temperature sensor	Signed Integer
1123	Maximum Gas Concentration Reported (%FS)	Maximum Gas Concentration reported by sensor	Unsigned Integer

6.4.2 Integration - Static Sensor Data

Input Register (*Function 04 Read*)

1124	Sensor Type Code	Type code of connected sensor module	16-bit unsigned Integer
1125	Display units sensor (PPM/PPB/VOL/LEL)	Indication of connected sensor gas concentration unit (ppm=1 , ppb =2, vol=3, lel=4) VOL/LEL scale x10 i.e. 123 = 12.3%	16-bit unsigned Integer
1126	Full-scale (PPM/PPB/VOL/LEL)	Full-scale in display units	16-bit unsigned Integer
1127	Local Low Alarm Set point (PPM/PPB/VOL/LEL)	Low Alarm in display units (alias of 2106)	16-bit unsigned Integer

1128	Local High Alarm Set point (PPM/PPB/VOL/LEL)	High Alarm in display units (alias of 2107)	16-bit unsigned Integer
1129	Calibration Gas Concentration (PPM/PPB/VOL/LEL)	Sensor Calibration gas concentration in display units	16-bit unsigned Integer
1130	Sensor Squelch, Unit dependent	Value below which gas concentration reads zero to suppress low level noise	16-bit unsigned Integer
1131	Low Alarm Behavior	Low Alarm Behavior Flag, Sensor. 0 => alarm triggered when gas above alarm level; 1 => alarm triggered when gas below alarm level	Boolean
1132	Sensor cal gas lower limit	Sensor calibration gas lower limit in display units	16-bit unsigned Integer
1133	Sensor cal gas upper limit	Sensor calibration gas upper limit in display units	16-bit unsigned Integer
1134	Sensor Low Alarm Limit	Sensor Low Alarm Limit in display units. Minimum level low alarm set point can be set to.	16-bit unsigned Integer
1135	% LEL to PPM Conversion Factor	%LEL to PPM conversion scaled x 10 (e.g. 44 for gas with 4.4% LEL)	16-bit unsigned Integer
1136	Gas Type Text Char 1,2	Gas Type Characters 1&2 (10 char gas string = "XXXXXXXXXX")	16-bit unsigned Integer
1137	Gas Type Text Char 3,4	Gas Type Characters 3&4 (10 char gas string = "XXXXXXXXXX")	16-bit unsigned Integer
1138	Gas Type Text Char 5,6	Gas Type Characters 5&6 (10 char gas string = "XXXXXXXXXX")	16-bit unsigned Integer
1139	Gas Type Text Char 7,8	Gas Type Characters 7&8 (10 char gas string = "XXXXXXXXXX")	16-bit unsigned Integer
1140	Gas Type Text Char 9,10	Gas Type Characters 9&10 (10 char gas string = "XXXXXXXXXX")	16-bit unsigned Integer
1141	Sensor Module SID Char 1,2	SID Characters 1&2 (8 char UID string = "XXXXXXXX")	16-bit unsigned Integer
1142	Sensor Module SID Char 3,4	SID Characters 3&4 (8 char UID string = "XXXXXXXX")	16-bit unsigned Integer
1143	Sensor Module SID Char 5,6	SID Characters 5&6 (8 char UID string = "XXXXXXXX")	16-bit unsigned Integer
1144	Sensor Module SID Char 7,8	SID Characters 7&8 (8 char UID string = "XXXXXXXX")	16-bit unsigned Integer
1145	Sensor Controller UID Char 1,2	UID Characters 1&2 (8 char UID string = "XXXXXXXX")	16-bit unsigned Integer
1146	Sensor Controller UID Char 3,4	UID Characters 3&4 (8 char UID string = "XXXXXXXX")	16-bit unsigned Integer
1147	Sensor Controller UID Char 5,6	UID Characters 5&6 (8 char UID string = "XXXXXXXX")	16-bit unsigned Integer
1148	Sensor Controller UID Char 7,8	UID Characters 7&8 (8 char UID string = "XXXXXXXX")	16-bit unsigned Integer
1149	Alias Text Char 1,2	Alias Characters (16 char alias string = "XXXXXXXXXXXXXXXXXX")	16-bit unsigned Integer

1150	Alias Text Char 3,4	Alias Characters (16 char alias string = "XXXXXXXXXXXXXXXXXX")	16-bit unsigned Integer
1151	Alias Text Char 5,6	Alias Characters (16 char alias string = "XXXXXXXXXXXXXXXXXX")	16-bit unsigned Integer
1152	Alias Text Char 7,8	Alias Characters (16 char alias string = "XXXXXXXXXXXXXXXXXX")	16-bit unsigned Integer
1153	Alias Text Char 9,10	Alias Characters (16 char alias string = "XXXXXXXXXXXXXXXXXX")	16-bit unsigned Integer
1154	Alias Text Char 11,12	Alias Characters (16 char alias string = "XXXXXXXXXXXXXXXXXX")	16-bit unsigned Integer
1155	Alias Text Char 13,14	Alias Characters (16 char alias string = "XXXXXXXXXXXXXXXXXX")	16-bit unsigned Integer
1156	Alias Text Char 15,16	Alias Characters (16 char alias string = "XXXXXXXXXXXXXXXXXX")	16-bit unsigned Integer
1157	Software Version Sensor Major	Major software version level (XX in firmware XX.YY.ZZ format)	16-bit unsigned Integer
1158	Software Version Sensor Minor	Minor software version level (YY in firmware XX.YY.ZZ format)	16-bit unsigned Integer
1159	Software Version Sensor Bug fix	Bug fix software version level (ZZ in firmware XX.YY.ZZ format)	16-bit unsigned Integer
1160	Temperature Lower Limit (°C)	Set Temperature Fault flag when Temp < Temperature Lower Limit	16-bit signed Integer
1161	Temperature Upper Limit (°C)	Set Temperature Fault flag when Temp > Temperature Upper Limit	16-bit signed Integer

6.4.3 Integration - General System Setup

Holding Register (*Function 03/06 Read/Write*)

2100	Parameter Unlock	Writing the correct unlock code allows an external controller to change system parameters (0000-9999)	16-bit unsigned Integer
2101	RS-485 Node Address	Modbus address 1-247 (if hardware override - write exception / read Modbus switch state)	16-bit unsigned Integer
2102	Baud Rate	0 = 9600 Baud; 1 = 19200 Baud (if hardware override - write exception / read dip8)	Boolean
2103	Stop Bits	Stop bits = 1 or 2	16-bit unsigned Integer
2104	Parity	0 = None, 1 = Odd, 2 = Even	16-bit unsigned Integer
2105	Enable 120ohm Termination	0 = No termination, 1 = termination enabled	Boolean
2106	Sensor Low Alarm (PPM/PPB/VOL/LEL)	Low gas alarm in display units (Local Alarm set points stored on controller, override sensor values)	16-bit unsigned Integer
2107	Sensor High Alarm (PPM/PPB/VOL/LEL)	High gas alarm in display units (Local Alarm set points stored on controller, override sensor values)	16-bit unsigned Integer

2108	Analogue output Range	Set voltage output (0=1-5V, 1=0-5V, 2=0-10V, 3=4-20mA, 4=2-10V) (if hardware override - write exception / read dip 2&3)	16-bit unsigned Integer
2109	Analogue output Zero Adjust	Sets Analogue output zero offset to allow output calibration (in DAC codes)	16-bit unsigned Integer
2110	Analogue output Span Adjust	Sets Analog output scaling factor to allow output calibration (in % scaled by x10 ie 123 = 12.3%)	16-bit unsigned Integer
2111	Buzzer disable	0 = Buzzer normal operation, 1 = Buzzer disabled (if hardware override - write exception / read dip 4)	Boolean
2112	Relay Contact Behavior / Failsafe	0 = NO relay, 1 = Failsafe relay (if hardware override - write exception / read dip 5)	Boolean
2113	Alarm Latching Behavior	0 = Alarms automatically reset, 1 = Alarms must be acknowledged (if hardware override - write exception / read dip 6)	Boolean
2114	Alarm ON Delay (0-900) seconds	Alarm on delay in seconds Range (0-900 secs), i.e. (0-15 mins). (if hardware override - write exception/ read dip 7)	16-bit unsigned Integer
2115	Alias Text Char 1,2	Alias Characters (16 char alias string = "XXXXXXXXXXXXXXXXXX")	16-bit unsigned Integer
2116	Alias Text Char 3,4	Alias Characters (16 char alias string = "XXXXXXXXXXXXXXXXXX")	16-bit unsigned Integer
2117	Alias Text Char 5,6	Alias Characters (16 char alias string = "XXXXXXXXXXXXXXXXXX")	16-bit unsigned Integer
2118	Alias Text Char 7,8	Alias Characters (16 char alias string = "XXXXXXXXXXXXXXXXXX")	16-bit unsigned Integer
2119	Alias Text Char 9,10	Alias Characters (16 char alias string = "XXXXXXXXXXXXXXXXXX")	16-bit unsigned Integer
2120	Alias Text Char 11,12	Alias Characters (16 char alias string = "XXXXXXXXXXXXXXXXXX")	16-bit unsigned Integer
2121	Alias Text Char 13,14	Alias Characters (16 char alias string = "XXXXXXXXXXXXXXXXXX")	16-bit unsigned Integer
2122	Alias Text Char 15,16	Alias Characters (16 char alias string = "XXXXXXXXXXXXXXXXXX")	16-bit unsigned Integer
2123	Unlock code	4-digit code used to unlock user settings (0000-9999), numeric, can only be read/written if system is already unlocked	16-bit unsigned Integer
2124	Bluetooth Passkey	6-digit Bluetooth passkey (000000-999999), numeric, can only be read/written if system is unlocked, requires power cycle to take effect	32-bit unsigned Integer
2125			

6.4.4 Integration – Calibration

Holding Register (*Function 03/06 Read/Write*)

2200	Sensor Calibration gas applied (PPM/PPB/VOL/LEL)	Concentration of calibration gas applied during calibration (must be set before calibration if using gas != sensor nominal) set to sensor nominal on reset	16-bit unsigned Integer
-------------	--	--	-------------------------

6.4.5 Integration - User Debug Tools

Holding Register (*Function 03/06 Read/Write*)

2800	Offline Mode	Setting this flag places the unit into offline mode. When offline the unit will not respond to gas events or generate alarm conditions. The flag will remain asserted for the duration of offline mode. Offline mode will end after 30 minutes or by clearing this flag.	Boolean
2801	Manual override Enable	Override external outputs to test system functionality. Time out after 30 minutes	Boolean
2802	Relay 1 state (Low Alarm)	Set state of relay 1 (1 = energized)	Boolean
2803	Relay 2 state (High Alarm)	Set state of relay 1 (1 = energized)	Boolean
2804	Relay 3 state (Fault)	Set state of relay 1 (1 = energized)	Boolean
2805	Buzzer state	Set state of buzzer (1 = active)	Boolean
2806	Green LED State	Set state of green LED (1 = on)	Boolean
2807	Red LED State	Set state of red LED (1 = on)	Boolean
2808	Analog Output Value	Set value of analog output in % full-scale (0% to 100%)	16-bit signed Integer
2809	Analog Output Value State	Set value control state of analog output (0=Manual, 1= Fault, 2 = Offline, 3 = Underflow, 4= Overflow , 5=PPM)	16-bit unsigned Integer

6.4.6 MGS Compatibility - Status Flags

Read Input Status (*Function 02 Read*)

3000	Alarm flag (0 or 1 = alarm) for Any Alarm	Set if low or high alarm state	Boolean
3001	Relay state (0 or 1=energized) for any Relay	Set if any relay is active (follows relay logical state not physical if failsafe is active)	Boolean
3002	Sensor fault (0 or 1 = fault) for Any Sensor or System Fault	Set if any fault flag is active	Boolean
3003	Red LED state (0 or 1=Red LED On)	Set if red LED is on	Boolean
3004	Green LED state (0 or 1=Green LED On)	Set if Green LED is on	Boolean
3005	Saturation (0 or 1= gas outside limits)	Set if gas concentration exceeds full-scale range	Boolean
3006	Start up (0=normal op 1=starting up)	Set if sensor is still in warm-up stabilization period	Boolean

6.4.7 Integration - Status Flags

Read Input Status (*Function 02 Read*)

3100	Sensor Startup (0 or 1 = startup)	Set if sensor is still in warm-up stabilization period	Boolean
3101	Low Alarm flag (0 or 1 = alarm)	Set if low alarm is active	Boolean
3102	High Alarm flag (0 or 1 = alarm)	Set if high alarm is active	Boolean
3103	Sensor Fault (0 or 1 = fault)	Set if any fault flag is active	Boolean
3104	Sensor Saturation (0 or 1 = gas outside limits)	Set if gas concentration exceeds full-scale range	Boolean
3105	Sensor Underflow (0 or 1 = gas less than zero)	Set if sensor is still in warm-up stabilization period	Boolean
3106	Calibration Due (0 or 1 = cal due)	Set if burning hours > calibration interval	Boolean

6.4.8 MGS Compatibility - Clear Special States

Read/Force Coil (*Function 01/05 Read/Write*)

4000	Mute Buzzer	Sounder Mute	Boolean
4001	Calibration due	Clear Calibration Due Flag	Boolean
4002	not implemented - return 0 on read/exception on write	Reconfigure MGS	Boolean

6.4.9 Integration - User Tasks

Read/Force Coil (*Function 01/05 Read/Write*)

4100	Restart	Force application restart	Boolean
4101	Factory Reset	Restore system settings to defaults	Boolean
4102	Clear last faults	Clear any fault flags held in the last fault registers. Any active faults will remain set in the last fault register	Boolean
4103	Acknowledge latched alarms/faults	Acknowledge latched alarms/faults	Boolean
4104	Mute Buzzer	Mute Buzzer for 60 minutes	Boolean
4105	Immediate Zero Calibration	Calibrate zero now	Boolean
4106	Immediate Span Calibration	Calibrate span now	Boolean
4107	Auto Zero Calibration	Calibrate zero after auto calibration time	Boolean
4108	Auto Span Calibration	Calibrate span after auto calibration time	Boolean
4109	Clear calibration expired flag	Clear calibration due flag and rest burning hours to 0	Boolean
4110	Clear Maximum Temperature	Clear Maximum Temperature	Boolean
4111	Clear Maximum Gas Concentration	Clear Maximum Gas Concentration	Boolean
4112	Bluetooth Enable	0 = Disable, 1 = Enable	Boolean

7. Ordering Information

7.1 Part Numbers

7.1.1 MGS-410 Configurations



IMPORTANT: In the following table, “MGS-410 Gas Detector” includes an instrument and one sensing head mounted directly to the instrument enclosure. Remote or secondary local sensors must be ordered as separate items.

Part Number	Description	Sensor Type
6302-0003	IP66-Rated Enclosure, Modbus Output (O2 low alarm 0-30%)	EC
6302-0026	IP66-Rated Enclosure, Modbus Output (NH3 0-100 ppm, LO TEMP)	EC
6302-0028	IP66-Rated Enclosure, Modbus Output (NH3 0-1,000 ppm, LO TEMP)	EC
6302-0033	IP66-Rated Enclosure, Modbus Output (NH3 0-5,000 ppm)	EC
6302-0040	IP66-Rated Enclosure, Modbus Output (CO 0-500 ppm)	EC
6302-0041	IP66-Rated Enclosure, Modbus Output (NO2 0-20 ppm)	EC
6302-0052	IP66-Rated Enclosure, Modbus Output (R600 0-100% LEL*)	IR
6302-0053	IP66-Rated Enclosure, Modbus Output (CH4 0-100% LEL*)	IR
6302-0054	IP66-Rated Enclosure, Modbus Output (R290 0-100% LEL*)	IR
6302-0062	IP66-Rated Enclosure, Modbus Output (% LEL Butane)	CAT
6302-0063	IP66-Rated Enclosure, Modbus Output (% LEL Methane)	CAT
6302-0064	IP66-Rated Enclosure, Modbus Output (% LEL Propane)	CAT
6302-0070	IP66-Rated Enclosure, Modbus Output (NH3 0-30k ppm)	CAT
6302-0090	IP66-Rated Enclosure, Modbus Output (CO2 0-5,000 ppm)	IR
6302-0091	IP66-Rated Enclosure, Modbus Output (CO2 0-10,000 ppm)	IR

6302-0092	IP66-Rated Enclosure, Modbus Output (CO2 0-20,000 ppm)	IR
6302-0093	IP66-Rated Enclosure, Modbus Output (CO2 0-30,000 ppm)	IR
6302-0094	IP66-Rated Enclosure, Modbus Output (CO2 0-40,000 ppm)	IR
6302-0095	IP66-Rated Enclosure, Modbus Output (CO2 0-50,000 ppm)	IR
6302-0101	IP66-Rated Enclosure, Modbus Output (R134a 0-1,000 ppm)	SC
6302-0103	IP66-Rated Enclosure, Modbus Output (R404A 0-1,000 ppm)	SC
6302-0105	IP66-Rated Enclosure, Modbus Output (R407A 0-1,000 ppm)	SC
6302-0107	IP66-Rated Enclosure, Modbus Output (R410A 0-1,000 ppm)	SC
6302-0109	IP66-Rated Enclosure, Modbus Output (R22 0-1,000 ppm)	SC
6302-0111	IP66-Rated Enclosure, Modbus Output (R507A 0-1,000 ppm)	SC
6302-0123	IP66-Rated Enclosure, Modbus Output (R407C 0-1,000 ppm)	SC
6302-0126	IP66-Rated Enclosure, Modbus Output (R407F 0-1,000 ppm)	SC
6302-0152	IP66-Rated Enclosure, Modbus Output (R1234ze 0-1,000 ppm)	SC
6302-0155	IP66-Rated Enclosure, Modbus Output (R32 0-1,000 ppm)	SC
6302-0156	IP66-Rated Enclosure, Modbus Output (R448A 0-1,000 ppm)	SC
6302-0157	IP66-Rated Enclosure, Modbus Output (R452A 0-1,000 ppm)	SC
6302-0158	IP66-Rated Enclosure, Modbus Output (R513A 0-1,000 ppm)	SC
6302-0159	IP66-Rated Enclosure, Modbus Output (R434A 0-1,000 ppm)	SC
6302-0160	IP66-Rated Enclosure, Modbus Output (R450A 0-1,000 ppm)	SC
6302-0161	IP66-Rated Enclosure, Modbus Output (R1234yf 0-1,000 ppm)	SC

	ppm)	
6302-0162	IP66-Rated Enclosure, Modbus Output (R514A 0-1,000 ppm)	SC
6302-0163	IP66-Rated Enclosure, Modbus Output (R452B 0-1,000 ppm)	SC
6302-0164	IP66-Rated Enclosure, Modbus Output (R454A 0-1,000 ppm)	SC
6302-0165	IP66-Rated Enclosure, Modbus Output (R422 0-1,000 ppm)	SC
6302-0166	IP66-Rated Enclosure, Modbus Output (R422D 0-1,000 ppm)	SC
6302-0167	IP66-Rated Enclosure, Modbus Output (R427A 0-1,000 ppm)	SC
6302-0169	IP66-Rated Enclosure, Modbus Output (R449A 0-1,000 ppm)	SC
6302-0170	IP66-Rated Enclosure, Modbus Output (R454C 0-1,000 ppm)	SC
6302-0300	IP66-Rated Enclosure, Modbus Output (R600a 0-5,000 ppm)	SC
6302-0301	IP66-Rated Enclosure, Modbus Output (R290 0-5,000 ppm)	SC
6302-0302	IP66-Rated Enclosure, Modbus Output (CH4 0-5,000 ppm)	SC
6302-0306	IP66-Rated Enclosure, Modbus Output (R600 0-5,000 ppm)	SC
6302-0307	IP66-Rated Enclosure, Modbus Output (HC12a 0-5,000 ppm)	SC
6302-0308	IP66-Rated Enclosure, Modbus Output (NH3 0-1,000 ppm)	SC
6302-0309	IP66-Rated Enclosure, Modbus Output (NH3 0-10,000 ppm)	SC

7.1.2 MGS-450 Configurations



IMPORTANT: In the following table, “MGS-450 Gas Detector” includes an instrument and one sensing head mounted directly to the instrument enclosure. Remote or secondary local sensors must be ordered as separate items.

Part Number	Description	Sensor Type
6302-1003	IP41-Rated Enclosure, 3xRelays, Analog & Modbus Outputs (O2 low alarm 0-30%)	EC
6302-1026	IP41-Rated Enclosure, 3xRelays, Analog & Modbus Outputs (NH3 0-100 ppm, LO TEMP)	EC
6302-1028	IP41-Rated Enclosure, 3xRelays, Analog & Modbus Outputs (NH3 0-1,000 ppm, LO TEMP)	EC
6302-1033	IP41-Rated Enclosure, 3xRelays, Analog & Modbus Outputs (NH3 0-5,000 ppm)	EC
6302-1040	IP41-Rated Enclosure, 3xRelays, Analog & Modbus Outputs (CO 0-500 ppm)	EC
6302-1041	IP41-Rated Enclosure, 3xRelays, Analog & Modbus Outputs (NO2 0-20 ppm)	EC
6302-1052	IP41-Rated Enclosure, 3xRelays, Analog & Modbus Outputs (R600 0-100% LEL*)	IR
6302-1053	IP41-Rated Enclosure, 3xRelays, Analog & Modbus Outputs (CH4 0-100% LEL*)	IR
6302-1054	IP41-Rated Enclosure, 3xRelays, Analog & Modbus Outputs (R290 0-100% LEL*)	IR
6302-1062	IP41-Rated Enclosure, 3xRelays, Analog & Modbus Outputs (% LEL Butane)	CAT
6302-1063	IP41-Rated Enclosure, 3xRelays, Analog & Modbus Outputs (% LEL Methane)	CAT
6302-1064	IP41-Rated Enclosure, 3xRelays, Analog & Modbus Outputs (% LEL Propane)	CAT
6302-1070	IP41-Rated Enclosure, 3xRelays, Analog & Modbus Outputs (NH3 0-30,000 ppm)	CAT

6302-1090	IP41-Rated Enclosure, 3xRelays, Analog & Modbus Outputs (CO2 0-5,000 ppm)	IR
6302-1091	IP41-Rated Enclosure, 3xRelays, Analog & Modbus Outputs (CO2 0-10,000 ppm)	IR
6302-1092	IP41-Rated Enclosure, 3xRelays, Analog & Modbus Outputs (CO2 0-20,000 ppm)	IR
6302-1093	IP41-Rated Enclosure, 3xRelays, Analog & Modbus Outputs (CO2 0-30,000ppm)	IR
6302-1094	IP41-Rated Enclosure, 3xRelays, Analog & Modbus Outputs (CO2 0-40,000 ppm)	IR
6302-1095	IP41-Rated Enclosure, 3xRelays, Analog & Modbus Outputs (CO2 0-50,000 ppm)	IR
6302-1101	IP41-Rated Enclosure, 3xRelays, Analog & Modbus Outputs (R134a 0-1,000 ppm)	SC
6302-1103	IP41-Rated Enclosure, 3xRelays, Analog & Modbus Outputs (R404A 0-1,000 ppm)	SC
6302-1105	IP41-Rated Enclosure, 3xRelays, Analog & Modbus Outputs (R407A 0-1,000 ppm)	SC
6302-1107	IP41-Rated Enclosure, 3xRelays, Analog & Modbus Outputs (R410A 0-1,000 ppm)	SC
6302-1109	IP41-Rated Enclosure, 3xRelays, Analog & Modbus Outputs (R22 0-1,000 ppm)	SC
6302-1111	IP41-Rated Enclosure, 3xRelays, Analog & Modbus Outputs (R507A 0-1,000 ppm)	SC
6302-1123	IP41-Rated Enclosure, 3xRelays, Analog & Modbus Outputs (R407C 0-1,000 ppm)	SC
6302-1126	IP41-Rated Enclosure, 3xRelays, Analog & Modbus Outputs (R407F 0-1,000 ppm)	SC
6302-1152	IP41-Rated Enclosure, 3xRelays, Analog & Modbus Outputs (R1234ze 0-1,000 ppm)	SC
6302-1155	IP41-Rated Enclosure, 3xRelays, Analog & Modbus Outputs (R32 0-1,000 ppm)	SC
6302-1156	IP41-Rated Enclosure, 3xRelays, Analog & Modbus Outputs (R448A 0-1,000 ppm)	SC
6302-1157	IP41-Rated Enclosure, 3xRelays, Analog & Modbus Outputs	SC

	(R452A 0-1,000 ppm)	
6302-1158	IP41-Rated Enclosure, 3xRelays, Analog & Modbus Outputs (R513A 0-1,000 ppm)	SC
6302-1159	IP41-Rated Enclosure, 3xRelays, Analog & Modbus Outputs (R434A 0-1,000 ppm)	SC
6302-1160	IP41-Rated Enclosure, 3xRelays, Analog & Modbus Outputs (R450A 0-1,000 ppm)	SC
6302-1161	IP41-Rated Enclosure, 3xRelays, Analog & Modbus Outputs (R1234yf 0-1,000 ppm)	SC
6302-1162	IP41-Rated Enclosure, 3xRelays, Analog & Modbus Outputs (R514A 0-1,000 ppm)	SC
6302-1163	IP41-Rated Enclosure, 3xRelays, Analog & Modbus Outputs (R452B 0-1,000 ppm)	SC
6302-1164	IP41-Rated Enclosure, 3xRelays, Analog & Modbus Outputs (R454A 0-1,000ppm)	SC
6302-1165	IP41-Rated Enclosure, 3xRelays, Analog & Modbus Outputs (R422 0-1,000 ppm)	SC
6302-1166	IP41-Rated Enclosure, 3xRelays, Analog & Modbus Outputs (R422D 0-1,000 ppm)	SC
6302-1167	IP41-Rated Enclosure, 3xRelays, Analog & Modbus Outputs (R427A 0-1,000 ppm)	SC
6302-1169	IP41-Rated Enclosure, 3xRelays, Analog & Modbus Outputs (R449A 0-1,000 ppm)	SC
6302-1170	IP41-Rated Enclosure, 3xRelays, Analog & Modbus Outputs (R454C 0-1,000 ppm)	SC
6302-1300	IP41-Rated Enclosure, 3xRelays, Analog & Modbus Outputs (R600a 0-5,000 ppm)	SC
6302-1301	IP41-Rated Enclosure, 3xRelays, Analog & Modbus Outputs (R290 0-5,000 ppm)	SC
6302-1302	IP41-Rated Enclosure, 3xRelays, Analog & Modbus Outputs (CH4 0-5,000 ppm)	SC
6302-1306	IP41-Rated Enclosure, 3xRelays, Analog & Modbus Outputs (R600 0-5,000 ppm)	SC
6302-1307	IP41-Rated Enclosure, 3xRelays, Analog & Modbus Outputs (HC12a 0-5,000 ppm)	SC

6302-1308	IP41-Rated Enclosure, 3xRelays, Analog & Modbus Outputs (NH3 0-1,000 ppm)	SC
6302-1309	IP41-Rated Enclosure, 3xRelays, Analog & Modbus Outputs (NH3 0-10,000 ppm)	SC
6302-2003	IP66-Rated Enclosure, 3xRelays, Analog & Modbus Outputs (O2 low alarm 0-30%)	EC
6302-2026	IP66-Rated Enclosure, 3xRelays, Analog & Modbus Outputs (NH3 0-100 ppm, LO TEMP)	EC
6302-2028	IP66-Rated Enclosure, 3xRelays, Analog & Modbus Outputs (NH3 0-1,000 ppm, LO TEMP)	EC
6302-2033	IP66-Rated Enclosure, 3xRelays, Analog & Modbus Outputs (NH3 0-5,000 ppm)	EC
6302-2040	IP66-Rated Enclosure, 3xRelays, Analog & Modbus Outputs (CO 0-500 ppm)	EC
6302-2041	IP66-Rated Enclosure, 3xRelays, Analog & Modbus Outputs (NO2 0-20 ppm)	EC
6302-2052	IP66-Rated Enclosure, 3xRelays, Analog & Modbus Outputs (R600 0-100% LEL*)	IR
6302-2053	IP66-Rated Enclosure, 3xRelays, Analog & Modbus Outputs (CH4 0-100% LEL*)	IR
6302-2054	IP66-Rated Enclosure, 3xRelays, Analog & Modbus Outputs (R290 0-100% LEL*)	IR
6302-2062	IP66-Rated Enclosure, 3xRelays, Analog & Modbus Outputs (% LEL Butane)	CAT
6302-2063	IP66-Rated Enclosure, 3xRelays, Analog & Modbus Outputs (% LEL Methane)	CAT
6302-2064	IP66-Rated Enclosure, 3xRelays, Analog & Modbus Outputs (% LEL Propane)	CAT
6302-2070	IP66-Rated Enclosure, 3xRelays, Analog & Modbus Outputs (NH3 0-30k ppm)	CAT
6302-2090	IP66-Rated Enclosure, 3xRelays, Analog & Modbus Outputs (CO2 0-5,000 ppm)	IR
6302-2091	IP66-Rated Enclosure, 3xRelays, Analog & Modbus Outputs (CO2 0-10,000 ppm)	IR
6302-2092	IP66-Rated Enclosure, 3xRelays, Analog & Modbus Outputs	IR

	(CO2 0-20,000 ppm)	
6302-2093	IP66-Rated Enclosure, 3xRelays, Analog & Modbus Outputs (CO2 0-30,000 ppm)	IR
6302-2094	IP66-Rated Enclosure, 3xRelays, Analog & Modbus Outputs (CO2 0-40,000 ppm)	IR
6302-2095	IP66-Rated Enclosure, 3xRelays, Analog & Modbus Outputs (CO2 0-50,000 ppm)	IR
6302-2101	IP66-Rated Enclosure, 3xRelays, Analog & Modbus Outputs (R134a 0-1,000 ppm)	SC
6302-2103	IP66-Rated Enclosure, 3xRelays, Analog & Modbus Outputs (R404A 0-1,000 ppm)	SC
6302-2105	IP66-Rated Enclosure, 3xRelays, Analog & Modbus Outputs (R407A 0-1,000 ppm)	SC
6302-2107	IP66-Rated Enclosure, 3xRelays, Analog & Modbus Outputs (R410A 0-1,000 ppm)	SC
6302-2109	IP66-Rated Enclosure, 3xRelays, Analog & Modbus Outputs (R22 0-1,000 ppm)	SC
6302-2111	IP66-Rated Enclosure, 3xRelays, Analog & Modbus Outputs (R507A 0-1,000 ppm)	SC
6302-2123	IP66-Rated Enclosure, 3xRelays, Analog & Modbus Outputs (R407C 0-1,000 ppm)	SC
6302-2126	IP66-Rated Enclosure, 3xRelays, Analog & Modbus Outputs (R407F 0-1,000 ppm)	SC
6302-2152	IP66-Rated Enclosure, 3xRelays, Analog & Modbus Outputs (R1234ze 0-1,000 ppm)	SC
6302-2155	IP66-Rated Enclosure, 3xRelays, Analog & Modbus Outputs (R32 0-1,000 ppm)	SC
6302-2156	IP66-Rated Enclosure, 3xRelays, Analog & Modbus Outputs (R448A 0-1,000 ppm)	SC
6302-2157	IP66-Rated Enclosure, 3xRelays, Analog & Modbus Outputs (R452A 0-1,000 ppm)	SC
6302-2158	IP66-Rated Enclosure, 3xRelays, Analog & Modbus Outputs (R513A 0-1,000 ppm)	SC
6302-2159	IP66-Rated Enclosure, 3xRelays, Analog & Modbus Outputs (R434A 0-1,000 ppm)	SC

6302-2160	IP66-Rated Enclosure, 3xRelays, Analog & Modbus Outputs (R450A 0-1,000 ppm)	SC
6302-2161	IP66-Rated Enclosure, 3xRelays, Analog & Modbus Outputs (R1234yf 0-1,000 ppm)	SC
6302-2162	IP66-Rated Enclosure, 3xRelays, Analog & Modbus Outputs (R514A 0-1,000 ppm)	SC
6302-2163	IP66-Rated Enclosure, 3xRelays, Analog & Modbus Outputs (R452B 0-1,000 ppm)	SC
6302-2164	IP66-Rated Enclosure, 3xRelays, Analog & Modbus Outputs (R454A 0-1,000 ppm)	SC
6302-2165	IP66-Rated Enclosure, 3xRelays, Analog & Modbus Outputs (R422 0-1,000 ppm)	SC
6302-2166	IP66-Rated Enclosure, 3xRelays, Analog & Modbus Outputs (R422D 0-1,000 ppm)	SC
6302-2167	IP66-Rated Enclosure, 3xRelays, Analog & Modbus Outputs (R427A 0-1,000 ppm)	SC
6302-2169	IP66-Rated Enclosure, 3xRelays, Analog & Modbus Outputs (R449A 0-1,000 ppm)	SC
6302-2170	IP66-Rated Enclosure, 3xRelays, Analog & Modbus Outputs (R454C 0-1,000 ppm)	SC
6302-2300	IP66-Rated Enclosure, 3xRelays, Analog & Modbus Outputs (R600a 0-5,000 ppm)	SC
6302-2301	IP66-Rated Enclosure, 3xRelays, Analog & Modbus Outputs (R290 0-5,000 ppm)	SC
6302-2302	IP66-Rated Enclosure, 3xRelays, Analog & Modbus Outputs (CH4 0-5,000 ppm)	SC
6302-2306	IP66-Rated Enclosure, 3xRelays, Analog & Modbus Outputs (R600 0-5,000ppm)	SC
6302-2307	IP66-Rated Enclosure, 3xRelays, Analog & Modbus Outputs (HC12a 0-5,000 ppm)	SC
6302-2308	IP66-Rated Enclosure, 3xRelays, Analog & Modbus Outputs (NH3 0-1,000 ppm)	SC
6302-2309	IP66-Rated Enclosure, 3xRelays, Analog & Modbus Outputs (NH3 0-10,000 ppm)	SC

7.1.3 MGS-460 Configurations



IMPORTANT: In the following table, “MGS-460 Gas Detector” includes an instrument and one sensing head mounted to a remote enclosure via 5m of cable (included).

Part Number	Description	Sensor Type
6302-4003	IP66-Rated Enclosure, 3xRelays, Analog & Modbus Outputs (O2 low alarm 0-30%)	EC
6302-4026	IP66-Rated Enclosure, 3xRelays, Analog & Modbus Outputs (NH3 0-100 ppm, LO TEMP)	EC
6302-4028	IP66-Rated Enclosure, 3xRelays, Analog & Modbus Outputs (NH3 0-1,000 ppm, LO TEMP)	EC
6302-4033	IP66-Rated Enclosure, 3xRelays, Analog & Modbus Outputs (NH3 0-5,000 ppm)	EC
6302-4040	IP66-Rated Enclosure, 3xRelays, Analog & Modbus Outputs (CO 0-500 ppm)	EC
6302-4041	IP66-Rated Enclosure, 3xRelays, Analog & Modbus Outputs (NO2 0-20 ppm)	EC
6302-4052	IP66-Rated Enclosure, 3xRelays, Analog & Modbus Outputs (R600 0-100% LEL*)	IR
6302-4053	IP66-Rated Enclosure, 3xRelays, Analog & Modbus Outputs (CH4 0-100% LEL*)	IR
6302-4054	IP66-Rated Enclosure, 3xRelays, Analog & Modbus Outputs (R290 0-100% LEL*)	IR
6302-4062	IP66-Rated Enclosure, 3xRelays, Analog & Modbus Outputs (% LEL Butane)	CAT
6302-4063	IP66-Rated Enclosure, 3xRelays, Analog & Modbus Outputs (% LEL Methane)	CAT
6302-4064	IP66-Rated Enclosure, 3xRelays, Analog & Modbus Outputs (% LEL Propane)	CAT
6302-4070	IP66-Rated Enclosure, 3xRelays, Analog & Modbus Outputs (NH3 0-30k ppm)	CAT

6302-4090	IP66-Rated Enclosure, 3xRelays, Analog & Modbus Outputs (CO2 0-5,000 ppm)	IR
6302-4091	IP66-Rated Enclosure, 3xRelays, Analog & Modbus Outputs (CO2 0-10,000 ppm)	IR
6302-4092	IP66-Rated Enclosure, 3xRelays, Analog & Modbus Outputs (CO2 0-20,000 ppm)	IR
6302-4093	IP66-Rated Enclosure, 3xRelays, Analog & Modbus Outputs (CO2 0-30,000 ppm)	IR
6302-4094	IP66-Rated Enclosure, 3xRelays, Analog & Modbus Outputs (CO2 0-40,000 ppm)	IR
6302-4095	IP66-Rated Enclosure, 3xRelays, Analog & Modbus Outputs (CO2 0-50,000 ppm)	IR
6302-4101	IP66-Rated Enclosure, 3xRelays, Analog & Modbus Outputs (R134a 0-1,000 ppm)	SC
6302-4103	IP66-Rated Enclosure, 3xRelays, Analog & Modbus Outputs (R404A 0-1,000 ppm)	SC
6302-4105	IP66-Rated Enclosure, 3xRelays, Analog & Modbus Outputs (R407A 0-1,000 ppm)	SC
6302-4107	IP66-Rated Enclosure, 3xRelays, Analog & Modbus Outputs (R410A 0-1,000 ppm)	SC
6302-4109	IP66-Rated Enclosure, 3xRelays, Analog & Modbus Outputs (R22 0-1,000 ppm)	SC
6302-4111	IP66-Rated Enclosure, 3xRelays, Analog & Modbus Outputs (R507A 0-1,000 ppm)	SC
6302-4123	IP66-Rated Enclosure, 3xRelays, Analog & Modbus Outputs (R407C 0-1,000 ppm)	SC
6302-4126	IP66-Rated Enclosure, 3xRelays, Analog & Modbus Outputs (R407F 0-1,000ppm)	SC
6302-4152	IP66-Rated Enclosure, 3xRelays, Analog & Modbus Outputs (R1234ze 0-1,000 ppm)	SC
6302-4155	IP66-Rated Enclosure, 3xRelays, Analog & Modbus Outputs (R32 0-1,000 ppm)	SC
6302-4156	IP66-Rated Enclosure, 3xRelays, Analog & Modbus Outputs (R448A 0-1,000 ppm)	SC
6302-4157	IP66-Rated Enclosure, 3xRelays, Analog & Modbus	SC

	Outputs (R452A 0-1,000 ppm)	
6302-4158	IP66-Rated Enclosure, 3xRelays, Analog & Modbus Outputs (R513A 0-1,000 ppm)	SC
6302-4159	IP66-Rated Enclosure, 3xRelays, Analog & Modbus Outputs (R434A 0-1,000 ppm)	SC
6302-4160	IP66-Rated Enclosure, 3xRelays, Analog & Modbus Outputs (R450A 0-1,000 ppm)	SC
6302-4161	IP66-Rated Enclosure, 3xRelays, Analog & Modbus Outputs (R1234yf 0-1,000 ppm)	SC
6302-4162	IP66-Rated Enclosure, 3xRelays, Analog & Modbus Outputs (R514A 0-1,000 ppm)	SC
6302-4163	IP66-Rated Enclosure, 3xRelays, Analog & Modbus Outputs (R452B 0-1,000 ppm)	SC
6302-4164	IP66-Rated Enclosure, 3xRelays, Analog & Modbus Outputs (R454A 0-1,000 ppm)	SC
6302-4165	IP66-Rated Enclosure, 3xRelays, Analog & Modbus Outputs (R422 0-1,000 ppm)	SC
6302-4166	IP66-Rated Enclosure, 3xRelays, Analog & Modbus Outputs (R422D 0-1,000 ppm)	SC
6302-4167	IP66-Rated Enclosure, 3xRelays, Analog & Modbus Outputs (R427A 0-1,000 ppm)	SC
6302-4169	IP66-Rated Enclosure, 3xRelays, Analog & Modbus Outputs (R449A 0-1,000 ppm)	SC
6302-4170	IP66-Rated Enclosure, 3xRelays, Analog & Modbus Outputs (R454C 0-1,000 ppm)	SC
6302-4300	IP66-Rated Enclosure, 3xRelays, Analog & Modbus Outputs (R600a 0-5,000 ppm)	SC
6302-4301	IP66-Rated Enclosure, 3xRelays, Analog & Modbus Outputs (R290 0-5,000 ppm)	SC
6302-4302	IP66-Rated Enclosure, 3xRelays, Analog & Modbus Outputs (CH4 0-5,000 ppm)	SC
6302-4306	IP66-Rated Enclosure, 3xRelays, Analog & Modbus Outputs (R600 0-5,000 ppm)	SC
6302-4307	IP66-Rated Enclosure, 3xRelays, Analog & Modbus Outputs (HC12a 0-5,000 ppm)	SC

6302-4308	IP66-Rated Enclosure, 3xRelays, Analog & Modbus Outputs (NH3 0-1,000 ppm)	SC
6302-4309	IP66-Rated Enclosure, 3xRelays, Analog & Modbus Outputs (NH3 0-10,000 ppm)	SC

7.1.4 MGS-400 Series Accessories

Part Number	Description
3015-8041	Horn + strobe 24 V DC; blue lens
3015-8044	Strobe; blue lens; MP120K 120 V AC adapter
3015-8043	Horn + strobe 24 V DC; red lens
3015-8046	Strobe; red lens; MP120K 120 V AC adapter
3015-8042	Horn + strobe 24 V DC; amber lens
3015-8045	Strobe; amber lens; MP120K 120 V AC adapter

7.1.5 MGS-400 Pre-calibrated Sensor Modules

Part Number	Description	Sensor Type
6302-9003	O2 low alarm 0-30%	EC
6302-9026	NH3 0-100 ppm, LO TEMP	EC
6302-9028	NH3 0-1,000 ppm, LO TEMP	EC
6302-9033	NH3 0-5,000 ppm	EC
6302-9040	CO 0-500 ppm	EC
6302-9041	NO2 0-20 ppm	EC
6302-9052	R600 0-100% LEL*	IR
6302-9053	CH4 0-100% LEL*	IR
6302-9054	R290 0-100% LEL*	IR
6302-9062	% LEL Butane	CAT
6302-9063	% LEL Methane	CAT
6302-9064	% LEL Propane	CAT

6302-9070	NH3 0-30k ppm	CAT
6302-9090	CO2 0-5,000 ppm	IR
6302-9091	CO2 0-10,000 ppm	IR
6302-9092	CO2 0-20,000 ppm	IR
6302-9093	CO2 0-30,000 ppm	IR
6302-9094	CO2 0-40,000 ppm	IR
6302-9095	CO2 0-50,000 ppm	IR
6302-9101	R134a 0-1,000 ppm	SC
6302-9103	R404A 0-1,000 ppm	SC
6302-9105	R407A 0-1,000 ppm	SC
6302-9107	R410A 0-1,000 ppm	SC
6302-9109	R22 0-1,000 ppm	SC
6302-9111	R507A 0-1,000 ppm	SC
6302-9123	R407C 0-1,000 ppm	SC
6302-9126	R407F 0-1,000 ppm	SC
6302-9152	R1234ze 0-1,000 ppm	SC
6302-9155	R32 0-1,000 ppm	SC
6302-9156	R448A 0-1,000 ppm	SC
6302-9157	R452A 0-1,000 ppm	SC
6302-9158	R513A 0-1,000 ppm	SC
6302-9159	R434A 0-1,000 ppm	SC
6302-9160	R450A 0-1,000 ppm	SC
6302-9161	R1234yf 0-1,000 ppm	SC
6302-9162	R514A 0-1,000 ppm	SC
6302-9163	R452B 0-1,000 ppm	SC
6302-9164	R454A 0-1,000 ppm	SC
6302-9165	R422 0-1,000 ppm	SC

6302-9166	R422D 0-1,000 ppm	SC
6302-9167	R427A 0-1,000 ppm	SC
6302-9169	R449A 0-1,000 ppm	SC
6302-9170	R454C 0-1,000 ppm	SC
6302-9300	R600a 0-5,000 ppm	SC
6302-9301	R290 0-5,000 ppm	SC
6302-9302	CH4 0-5,000 ppm	SC
6302-9306	R600 0-5,000 ppm	SC
6302-9307	HC12a 0-5,000 ppm	SC
6302-9308	NH3 0-1,000 ppm	SC
6302-9309	NH3 0-10,000 ppm	SC

7.2 Service Center Locations

Prior to shipping equipment to Bacharach, visit www.mybacharach.com for a Returned Merchandise Authorization Number (*RMA #*). All returned goods must be accompanied by a *RMA #*. Pack the equipment securely (*in its original packing, if possible*), as Bacharach cannot be held responsible for any damage incurred during shipping to our facility.

Location	Contact Information	Shipping Address
United States	Phone: +1 724 334 5000 Toll Free: +1 800 736 4666 Fax: +1 724 334 5001 Email: help@mybacharach.com	Bacharach, Inc. 621 Hunt Valley Circle New Kensington, PA 15068, USA ATTN: Service Department
Europe	Phone: +353 1 284 6388 Fax: +353 1 284 6389 Email: help@mybacharach.com	Bacharach, Inc. 114A Georges Street Lower Dun Laoghaire, Dublin, Ireland ATTN: Service Department
Canada	Phone: +1 905 882 8985 Fax: +1 905 882 8963 Email: support@bachcan.ca	Bacharach, Inc. 10 West Pearce Street, Unit 4 Richmond Hill, Ontario L4B 1B6, Canada ATTN: Service Department