

Technical Manual

Version 1.04 and up

Safety

WARNING

Read and understand contents of this manual prior to operation.
Failure to do so could result in serious injury or death.

IMPORTANT SAFETY

The following terms and symbols are used in this manual to alert the operator of important instrument operating issues:

 This symbol is intended to alert the user to the presence of important operating and maintenance (servicing) instructions.

 This symbol is intended to alert the user to the presence of dangerous voltage within the instrument enclosure that may be of sufficient magnitude to constitute a risk of electric shock.

 This symbol signifies the system's ground terminal

DC refers to direct current voltages.

VAC refers to alternating voltages.

WARNINGS

- **Shock Hazard** - Disconnect or turn off power before servicing this instrument.
- **NEMA 4X wall mount models** should be fitted with a locking mechanism after installation to prevent access to high voltages by unauthorized personnel (see [Figure 4-1](#)).
- **Only the combustible monitor portions** of this instrument have been assessed by CSA for 122.2 No. 152 performance requirements (for

mA input only).

- This equipment is suitable for use in Class I, Division 2, Groups A,B,C and D or non-hazardous locations only.
- **EXPLOSION HAZARD- SUBSTITUTION OF COMPONENTS MAY IMPAIR SUITABILITY FOR CLASS I, DIVISION 2.**
- **EXPLOSION HAZARD- DO NOT REPLACE FUSE UNLESS POWER HAS BEEN SWITCHED OFF OR THE AREA IS KNOWN TO BE NON-HAZARDOUS.**
- **EXPLOSION HAZARD- DO NOT DISCONNECT EQUIPMENT UNLESS POWER HAS BEEN SWITCHED OFF OR THE AREA IS KNOWN TO BE NON-HAZARDOUS.**

CAUTIONS

- Use a properly rated **CERTIFIED AC power (mains) cable** installed as per local or national codes.
- For DC powered units, **DC power must be from a SELV rated source.**
- A certified AC power (mains) disconnect or circuit breaker should be mounted near the controller and installed according applicable local and national codes. If a switch is used instead of a circuit breaker, a properly rated **CERTIFIED fuse or current limiter** is required to be installed as per local or national codes. Markings for positions of the switch or breaker should state (I) for on and (O) for off.
- Clean using only a damp cloth with no solvents.
- Equipment not used as prescribed within this manual may impair overall safety

Table of Contents

Safetyi

1 General Description

1 General Description.....1-2

1.1 Data Display Screens1-3

1.2.1 Engineering Unit Screen1-3

1.2.2 Bar Graph Screen1-3

1.2.3 Trend Screen1-3

1.3 Specifications1-3

1.3.1 Power Supply Requirements.....1-3

1.3.2 Relays1-4

1.3.3 Ambient Temperature Range1-4

1.3.4 Humidity Range1-4

1.3.5 Altitude1-4

1.3.6 Housings / Installation Categories1-5

1.3.7 Approvals1-5

1.3.3 Ambient Temperature Range1-5

1.3.4 Humidity Range1-5

1.3.5 Altitude1-5

1.3.6 Housings / Installation Categories1-5

1.3.7 Approvals1-5

2 Operation

2 Operation	2-2
2.1 Setup Menu Configuration	2-2
2.2 Changing Menu Variables Using the Keypad	2-3
2.2.1 Setup Configuration Menus	2-3
2.2.2 Channel Setup Entry Menu.....	2-3
2.2.3 Fault / Alarm 1 / Alarm 2 / Alarm 3 Set-Up Menus.....	2-4
2.2.4 Configure Menu To Define Channel	2-4
Name / Eunits ASCII Data Fields	2-5
Input Measurement Range.....	2-5
Decimal Point Resolution	2-5
Turning Off Unused Channels.....	2-5
2.2.5 Cal Setup Menu	2-6
2.2.6 Calibrate Input Menu.....	2-6
2.3 System Configuration Menus	2-7
2.3.1 Standard / Optional Relay Setup Menus.....	2-7
2.3.2 Clock / Delays Menu	2-8
2.3.3 COMM Port Remote ID Menu	2-8
2.3.4 Analog Setup Menu	2-9
2.3.5 Horn / Acknowledge Menu	2-9
2.4 HA40 System Security Menu	2-10

3 Motherboard Interface PCB

- 3 Motherboard Interface PCB3-2**
- 3.1 Input / Output Optional PCB's3-3**
 - 3.1.2 Optional Analog Input PCB3-4
 - 3.1.3 Optional Discrete Relay PCB's.....3-4
 - 3.1.4 Optional 4-20mA Analog Output Board.....3-5
- 3.2 MODBUS RS-232 / RS-485 Interface Option3-6
 - 3.2.1 MODBUS Register And Function Code Summary.....3-6

4 Enclosures

- 4 Enclosures4-2**
 - 4.1 HA40N4 NEMA 4X Wall Mount Enclosure4-2
 - 4.2 HA40XP NEMA 7 Explosion-Proof Wall Mount Enclosure.....4-2

5 Parts List

- 5 Parts List5-2**

6 Specifications

- 5 Specifications6-2**

7 Warranty

- Honeywell Analytics Warranty Statemen.....7-2**

1 General Description

1 General Description

The Honeywell Analytics HA40 Quad Channel Controller is designed to display, and control alarm event switching for four inputs. Inputs are typically voltage or 4-20mA current from transmitters, monitors or other analog output devices. The HA40 is equipped with a Fault and three alarm levels per channel with features such as ON / OFF delays, latching relays and alarm Acknowledge. A dedicated horn driver circuit for a local audible annunciator is also standard. Two standard 5-amp alarm relays are configurable via the “alarm voting” menu to make relays trip based on various alarm combinations. A real-Time Clock and Calendar are also standard. Options such as 4-20mA outputs, discrete relays for each alarm and audible annunciators are easily added. RS-485 (Modbus RTU) or Ethernet (Modbus TCP) ports are also available for sending data to PC’s, PLC’s, DCS’s, or other Honeywell Analytics controllers.

A 128 x 64 pixel graphic LCD readout displays monitored data as bar graphs, 30-minute trends and engineering units. System configuration is via user friendly menus and all configuration data is retained in non-volatile memory during power interruptions. The HA40 front panel is shown in Figure 1-1 displaying the bar graph data screen. The five keypad symbols below the display are magnetically activated using the supplied magnetic wand without opening the enclosure. Opening the enclosure door provides access to the keypad buttons as shown in Figure 1-2.

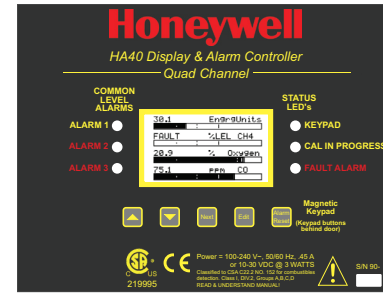

Figure 1-1. Front Panel

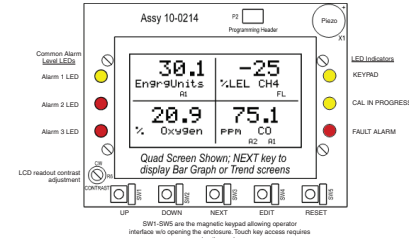

Figure 1-2. Front Panel Display (open enclosure)

1.1 Data Display Screens

The HA40 Controller offers three modes for displaying monitored data, shown in Figure 1-4.

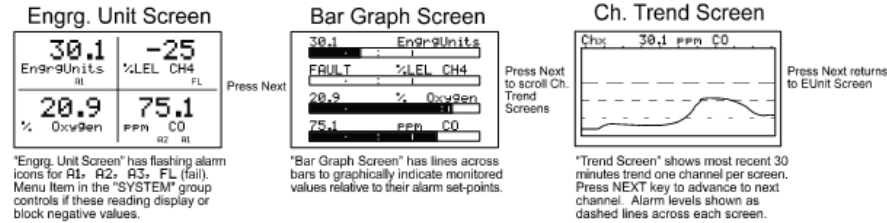

Figure 1-4. Data Display Screens

1.2.1 Engineering Unit Screen

The Engineering Unit screen shown in Figure 1-4 allows each channel's value and its 10-digit Eunits tag to be viewed simultaneously. A1, A2, A3, FL icons at lower right of each reading flash if ALARM 1, 2, 3 or FAULT alarms activate for this channel.

1.2.2 Bar Graph Screen

Values are displayed graphically as bar graphs with alarm levels indicated by vertical dashed lines across each bar. The bar graph screen is very useful for emphasizing current reading relative to the channel's alarm set-point. Live readings and their Eunits tag appear above each bar graph.

1.2.3 Trend Screen

The HA40 also provides 30-minute trend screens for each channel as shown in Figure 1-4. Live readings and their Eunits tag are displayed across the top of each trend screen. Channel numbers are shown in the upper right and are selected by the Next key. A1, A2 and A3 alarm levels appear as horizontal dashed lines across the screen.

1.3 Specifications

1.3.1 Power Supply Requirements

The HA40 is equipped with an integral 15 watt universal AC input / 24 VDC output switching power supply. Standard HA40 AC power requirements are 100-240 VAC 50/60 Hz @ .45 amp max (including inrush) and 20 watts steady state, applied to TB5 on the motherboard. If AC power is not available, the HA40 may also be powered with 24 VDC applied to TB1 on the motherboard. A primary DC source or back-up DC source capability should be determined by the total system power budget calculation with guard-band included. A back-up DC power source may also be connected to TB1 for automatic switchover if the AC power source fails. See [Figures 3-1 & 3-2](#) for wiring information.



WARNING

A back-up or external DC power source DOES NOT source aux power output (TB3 - see [Figure 3.1](#))

The basic HA40 consumes only 1.5 watts of 10-30 VDC from the integral power supply.

Optional features, and external devices such as remote transmitters, increase power consumption as described below:

- Discrete Relay PCB option; add 1.5 watt.
- 4-20mA Output PCB option; add .5 watt.
- TB3 terminals 1 & 2 on the motherboard provide a maximum of 350mA output power for powering of auxiliary external devices such as relays, lamps or transmitters (see [Figure 3-1](#)). Power consumed from these terminals must be included when calculating system power consumption. 10-0221-4, Analog Input PCB option; add wattage for each monitor connected to this board's 24 VDC terminals.

Some applications require HA 40 controllers to source power for high power monitors. If the integral 15 watt power is not enough, a 24VDC, 50 watt power supply, UL rated for Div 2 hazardous areas is available. This option is also available with a Div 1 enclosure if an explosion-proof enclosure is required. (See [Section 5 - Specifications](#).)

WARNING

A backup, or external DC power source DOES NOT source auxiliary power output (see figure 3.1 TB3).

1.3.2 Relays

Two mechanical (dry contact) Common Form C relays are standard and may be mapped to various alarm events as described in [Section 2.3.1](#). HA40's may also be equipped with optional solid-state common Form A relays (see [Section 5 - Specifications](#) for details) in applications requiring non-arcing switching. Solid-state relays are recommended for switching of highly inductive loads.

A six mechanical (dry contact) Discrete Relay option board (see [Section 3.1.6](#)) provides dedicated Form C relays for ALARM 1, ALARM 2 and FAULT for all channels.

WARNING

All mechanical (dry contact) relays are rated at 5 Amp for 28 VDC and 250 ~VAC RESISTIVE loads. IMPORTANT: Appropriate diode (DC loads) or MOV (AC loads) snubber devices must be installed with inductive loads to prevent RFI noise spikes.

Optional solid state relays are rated at 2 Amp 12-280~VAC (600Vpk). Relay wiring should be kept separate from low level signal wiring.

1.3.3 Ambient Temperature Range

-25 to 50 degrees C

1.3.4 Humidity Range

0 to 90% R. H. Non-Condensing.

1.3.5 Altitude

Recommended up to 2000 meters

1.3.6 Housings / Installation Categories

NEMA 4X wall mount. DIV 2 Groups A,B,C,D; Category II and • pollution degree 3; NEMA 4X; IP66
NEMA 7 wall mount for DIV 1 & 2 Groups B,C,D; includes • o-ring in door to satisfy NEMA 4 rating.*Includes standard non-intrusive magnetic keypad.

1.3.7 Approvals

CSA C22.2 No 1010.1 and ISA S82.02•

CSA C22.2 No 152 for combustibles using mA input

UL 1604/C22.2 No. 213 (Div 2 Groups A,B,C,D)

EN55011 & EN61000 (CE Mark) CSA File # = 219995

1.3.3 Ambient Temperature Range

-25 to 50 degrees C

1.3.4 Humidity Range

0 to 90% R. H. Non-Condensing.

1.3.5 Altitude

Recommended up to 2000 meters

1.3.6 Housings / Installation Categories

- *NEMA 4X wall mount. DIV 2 Groups A,B,C,D; Category II and pollution degree 3; NEMA 4X; IP66
- *NEMA 7 wall mount for DIV 1 & 2 Groups B,C,D; includes o-ring in door to satisfy NEMA 4 rating.

*Includes standard non-intrusive magnetic keypad.

1.3.7 Approvals

- CSA C22.2 No 1010.1 and ISA S82.02
- CSA C22.2 No 152 for combustibles
- UL 1604 / C22.2 No 213 (Div 2 Groups A,B,C,D)
- EN55011 & EN61000 (CE Mark). CSA File # = 219995 and may be seen at: www.CSA-International.org.

2 Operation

2 Operation

The HA40's graphic LCD displays monitored data. The 5-button keypad and the display serve as the system's operator interface. All HA40 configuration variables are entered using this operator interface through SETUP menus accessed by pressing **Edit** from either data screen. This Setup mode may be exited manually by pressing **Next**, or automatically when no keys are pressed for 5 minutes. Alarm relays and front panel alarm LED indicators remain active during the Setup mode. Alarm LED's flash upon new alarms and become steady after Acknowledged by pressing the **Alarm Reset** key. A SECURITY menu offers a password feature to prevent tampering with HA40 parameters.

A "sign-on" screen appears briefly after power is applied that indicates what type of input / output options are configured with the unit.

2.1 Setup Menu Configuration

Variables inside the CHANNEL (see [Section 2.2](#)) and SYSTEM (see [Section 2.3](#)) menu trees allow HA40 configuration for a wide range of monitoring applications. Select the desired menu by scrolling with Up/down arrows and then Edit to enter each menu. [Figure 2-1](#) illustrates the menus tree for configuring Channel and System specific variables. Channel variables affect only the specific channel selected while System variables are related to features not specific to any channel.

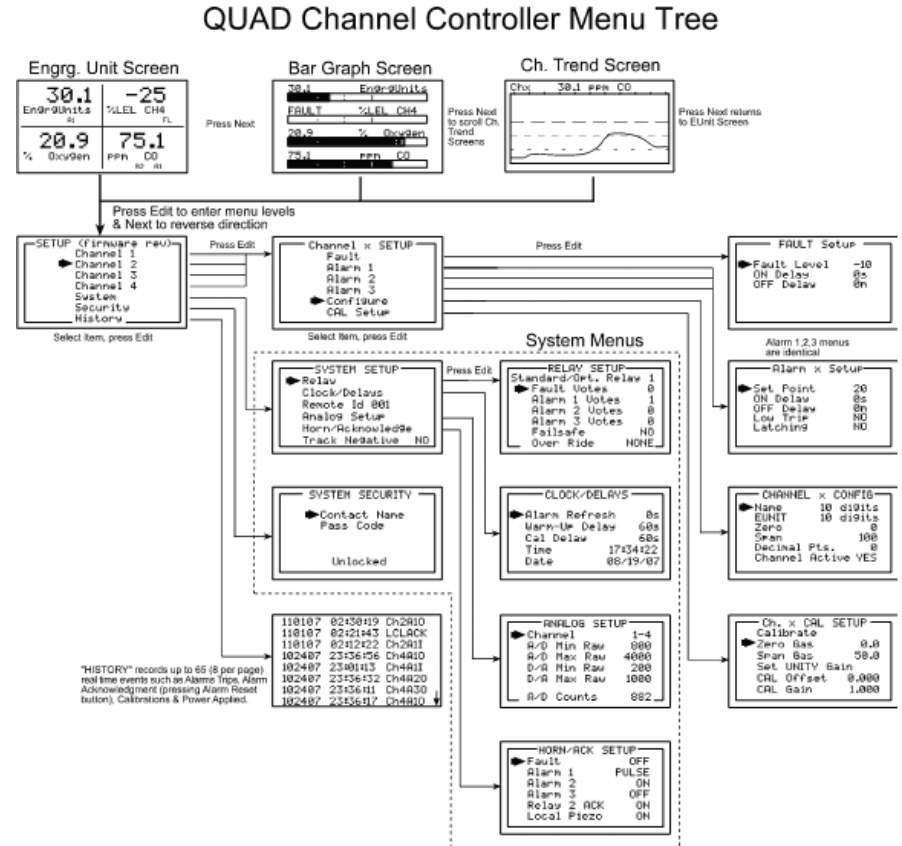

2.2 Changing Menu Variables Using the Keypad



Upon entering a menu, a pointer controlled by the Up/down arrows keys points to the selected variable. Some are simple YES/NO or ON/OFF entries toggled by pressing the Edit key. Others, such as Channel ID and Eunits fields may have many ASCII character possibilities. Allowed ASCII characters are as follows:

ABCDEFGHIJKLMNOPQRSTUVWXYZ[\]^_`abcdefghijklmnopqrstuvwxyz vwxyz blank space"#\$%&`()*+,-./0123456789:;<=>?@.

Notice the often used blank character is located after lower case z and before the exclamation point !. Edit places a cursor under the item and Up/down arrows scroll through each allowed entry. The Next key moves the cursor to the next position within a field. When the field is complete, Edit clears the cursor and loads the field into non-volatile memory where it is retained indefinitely. Without a cursor present, the Next key closes open menus in reverse order and returns the LCD to the data display.

2.2.1 Setup Configuration Menu

The **SETUP** menu (shown in the middle of Figure 2-16 and in Figure 2-17) is accessed by pressing **Edit** when any data display is present. This is the entry-level screen to *all* Channel, System and Security menus. It also shows the firmware version operating in the HA40. Use the up/down arrow keys to move the pointer to the desired menu and press the **Edit** key.

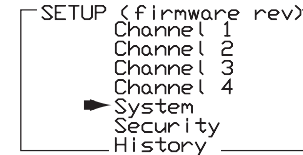

Figure 2-1. Setup Configuration Menu

2.2.2 Channel Setup Entry Menu

The **Channel x SETUP** menu shown in Figure 2-18 allows configuration of all variables for the selected channel. These are Fault, Alarm 1, Alarm 2, Alarm 3, Configure and CAL Setup.

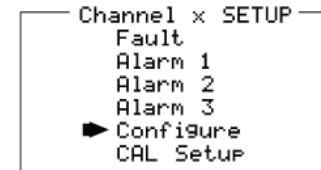

Figure 2-2. Channel Setup Entry Menu

2.2.3 Fault / Alarm 1 / Alarm 2 / Alarm 3 Set-Up Menus

Alarm 1, 2 and 3 have identical menus. The only difference between each is that A1 front panel LED indicators are yellow while A2 and A3 are red. Typical applications often have A1 set at a WARN level, A2 at a HIGH level and A3 at a higher SHUT DOWN level. However, it is important to understand there is no functional difference between A1, A2 and A3 (since their configuration menus are identical, only one is shown in Figure 2-19). The **Fault** menu is identical to A1, A2, A3 except Fault alarms are always low trips (alarm activates as input goes below the set point) and Fault alarms may not be set for latching operation.

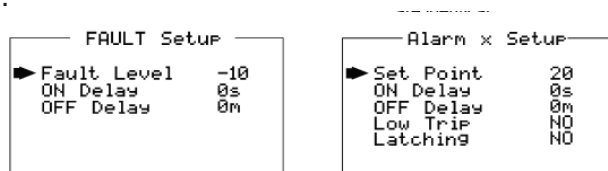

Figure 2-3. Alarm/Fault Setup Menu

- **Set Point** is entered in engineering units and determines the value at which the alarm trips. For example, if a channel monitors 0-50 ppm H₂S and the desired alarm level is 10 ppm, the correct entry is 10.00. A one percent dead band prevents alarm chatter. This means after tripping an alarm the input must move at least 1% of full scale back through the setpoint for the alarm to auto reset.
- The **ON Delay / OFF Delay** entries allow ON and OFF time delays affecting how long the trip-point must be surpassed before an alarm event transition occurs. ON delays are limited to 10 seconds while OFF delays may be as long as 120 minutes. Delays are useful in many applications to prevent nuisance alarms and unwanted cycling into and out of alarm conditions.

- **Low Trip** is set for NO to increase alarms or YES to decrease alarms to determine if the alarm activates upon exceeding or falling below the set-point.
- **Latching** determines either manual or automatic alarm reset operation. YES requires a manual Alarm Reset to unlatch the alarm even though an alarm condition no longer exists. YES also causes this alarm's common relay, front panel LED, and optional discrete relay to latch. NO allows all outputs for this alarm to automatically reset after the alarm condition clears.

Common alarm LED indicators on the left side of the front panel indicate the status of A1, A2 A3 alarms. The common Fault LED is on the lower right side of the front panel. Any new alarm event causes the associated LED to flash until an Alarm Reset occurs causing an acknowledged steady on condition. Operators should recognize new alarms by a flashing LED. Alarm Reset also acknowledges, or deactivates, audible devices driven by the AUDIBLE ALARM option connector J2 (see [Figure 3.2](#))

2.2.4 Configure Menu To Define Channel

The next menu option, after the Alarm menu, is Configure. It allows setting Name and EUNIT 10 digit ASCII fields, defines the measurement range with ZERO & SPAN entries, number of Decimal Points of resolution the reading will have, and if the channel is Active.

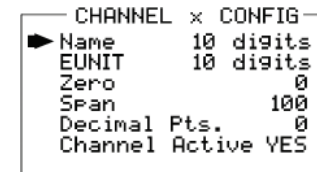

Figure 2-4. Configure Menu to Define Channel

Name / Eunits ASCII Data Fields

The first two items in this menu are for entering the 10 character channel Name and engineering unit ASCII fields. Name should describe the channel's data in user terminology such as tag # or other description. Eunits should define the units of measure for what this channel is to display. Section 2.6 describes how to modify these fields using the keypad.

Input Measurement Range

The **Zero / Span** menu options allow configuration of the measurement range displayed by this channel. Measurement Range defines the range of the input signal's engineering units. For example, if a channel's input is 4-20mA from a transmitter monitoring 0 to 10ppm chlorine, then the Zero value should equal 0.000 and the Span value equal 10.00. Four digits must be entered so trailing 0's may appear here that are not displayed on other data screens. These menus work hand in hand with the Min/Max Raw Counts menus described in section 2.7.4.

Decimal Point Resolution

Resolution of the displayed channel value is configured in the **Decimal Pts.** menu by setting the number of digits trailing the decimal point. Displayed readings are limited to a maximum of four digits with a polarity sign. Auto-ranging displays the highest resolution allowed by this menu's decimal point entry. For example, a range of 0 to 100ppm and two decimal points reads 0.00 at 0ppm and 100.0 at 100ppm. This may be undesirable due to the high resolution at zero unless the sensor's output is extremely stable. If decimal points are limited to one, the 0ppm reading becomes 0.0 and the 100ppm reading remains 100.0. Resolution may be limited further by setting decimal points to 0 where in the above example, 0ppm reads 0 and 100ppm reads 100.

Turning Off Unused Channels

The **Channel Active** menu option asks if this channel is to be utilized. NO causes the controller to never process inputs applied to this channel and no alarms are tripped or data displayed. Inactive channels have a line drawn through them on the Setup screen to indicate they are turned off.

2.2.5 Cal Setup Menu

The CAL SETUP feature supports pushbutton calibration of zero and span values. This feature should only be utilized when there are no other zero/span controls within the monitoring system since it is inappropriate to calibrate a signal at more than one point. Therefore, if calibration will be performed at another transmitter or monitoring device, the CAL SETUP feature should not be used.

The **CAL SETUP** menu allows entering the correct Zero Gas & Span Gas set-point values needed to calibrate the channel. These are entered in the same engineering units as input range.

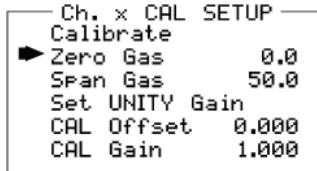

Figure 2-5. Cal Setup Menu

2.2.6 Calibrate Input Menu

The CAL SETUP flow chart (shown in Figure 2-6) is designed to make calibration quick, easy and error free. A successful ZERO and SPAN calibration requires only a few keystrokes. Optional 4-20mA outputs (if equipped) transmit 1.5mA during calibration and 4mA during the subsequent CAL DELAY to prevent triggering external alarms during calibration. Local HA40 alarm relays are inhibited during calibration. Unintentional calibrations may be reset using the Set UNITY menu item. Set UNITY resets Cal OFFSET to 0 & Cal GAIN to 1 which is useful for returning the calibration to a known starting place. Sensor aging may be monitored by recording zero and span readings at Unity Gain when the sensor is new, and again later when degradation may have occurred. CAL MODE automatically exits if no keystroke is detected after 5 minutes.

Use the following step-by-step procedure to perform ZERO and SPAN calibrations.

1. To enter the CAL SETUP from any data display, press the dual purpose down arrow / CAL key then use the up/down arrow keys to select the channel to calibrate.
2. Stimulate the monitor to be calibrated with an appropriate ZERO calibration standard. Observe the screen's live reading and when it is stable press the Edit key to perform the ZERO calibration.
3. If the ZERO calibration is successful, CAL SETUP automatically proceeds to the SPAN check.
4. Apply the correct SPAN calibration standard. After the reading is stable, press the Edit key to perform a SPAN calibration.



WARNING

The SPAN calibration standard used must match the value specified since this is the reading the HA40 will indicate after a successful SPAN calibration. The SPAN calibration value may be edited if it becomes necessary to apply a different calibration standard to set SPAN (see Span Calibration in section 2.2.5).

5. If the SPAN calibration is successful, the display flashes "REMOVE CAL GAS" and starts the CAL DELAY.
6. CAL SETUP is complete after the end of the CAL DELAY.

The flow chart in Figure 2-6 illustrates the above procedure. UP, CAL, Next & Edit labels indicate keystrokes (down arrow/CAL is a dual purpose key). The CAL SETUP information screen (top of the chart) is available for advanced users to see Offset / Gain calibration constants and live analog to digital converter (A/D) counts. Span set point calibration values may also be edited from this screen. Holding the up key, for 5 seconds during CAL SETUP, displays this screen.

Unity Gain may be used at anytime to cancel incorrect calibrations and start again. Unity means Offset = 0.00 and Gain = 1.00.

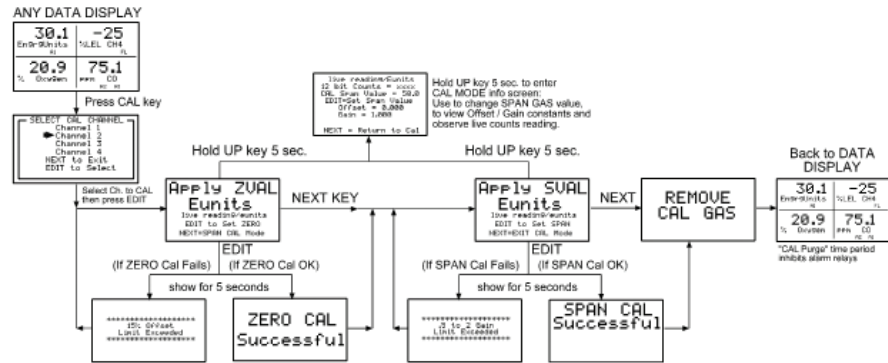

Figure 2-6. Cal Flow Chart

2.3 System Configuration Menus

Several items needing configuration are not specific to any channel but affect the entire HA40 system. These are located in the SYSTEM menu group shown in the dotted line box in Figure 2-7. System menus are accessed through the SETUP menu shown in Figure 2-23 by pointing to the desired item and pressing Edit.

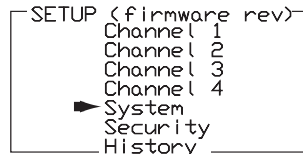

Figure 2-7. System Configuration Menu

2.3.1 Standard / Optional Relay Setup Menu

The menu shown in Figure 2-8 allows configuring of both the standard Relay 1 & Relay 2 motherboard relays and the six optional relays on the 10-0222 discrete relay option PCB. Both standard and optional relays are programmed in this menu. Select the relay to be configured by pointing the arrow at the top menu item and pressing Edit. The field will scroll through all eight possible relays (2 standard and 6 optional).

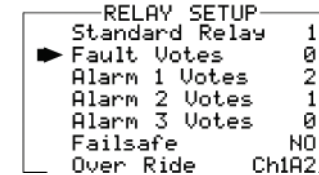

Figure 2-8. Relay Setup Menu

- **Fault, Alarm 1, Alarm 2, Alarm 3** menus (Figure 2-8) offer additional “voting” flexibility by controlling the channel alarm combinations that will trip the selected relay. Each **Votes** entry requires the specified quantity of that alarm to be active before this relay activates. As illustrated in Figure 2-24 Standard Relay 1 activates when any 2 channels have Alarm 1 conditions, PLUS, any one channel has an Alarm 2 condition. Fault Votes and Alarm 3 Votes values are 0 therefore Fault and Alarm 3 conditions will not affect this relay.
- **Failsafe** set for YES causes this relay to be energized when its voting requirements are false (no alarm condition) and de-energized when the alarm vote requirements are true. The primary benefit of failsafe is loss of power places the relay contacts into the alarm condition.

- **Over Ride** menu allows entering one of the 16 different alarms that will trip this relay regardless of the Votes entries. There are four alarms per channel and four channels and any one of these alarms may be used as the Over Ride. This feature is useful when one channel's alarm has more significance than the others.
- **Horn** controls how activating this relay will affect the horn driver circuit connected to J2 on the motherboard. Choices are NO, STEADY or PULSE. Warning level alarms might be set to pulse the horn and high alarms set for steady. Personnel can then know which alarm level is present by hearing the pulsing or steady horn.
- Turning Acknowledge ON (not allowed on Relay 1) allows Relay 2 to be deactivated during alarm conditions by an Alarm Reset. This is useful if another audible device is being driven by the relay. The acknowledge feature is not available for Relay 1 since it is often used for driving a warning light and Relay 2 for driving a horn. It could be dangerous if an operator acknowledged the horn AND the light since no indication of the high alarm condition would remain.

2.3.2 Clock / Delays Menu

The HA40 monitors signals from inputs that may require varying times to stabilize after power is applied and after calibrations are complete.

- **Alarm Refresh** menu allows reactivation of Acknowledged alarms after the time period expires. This feature is used primarily to restart audible alarm devices after having been silenced by an acknowledge function (via serial port or pressing the Alarm Reset button). An entry of 0 seconds effectively disables the Alarm Refresh function.

- **Warm-Up Delay** menu allows setting how long alarm relays remain disabled after power is applied.
- **Cal Delay** determines how long alarm relays are inhibited after completing a calibration.
- **Time** and **Date** menu items are for setting the correct time and date. The HA40 is equipped with a 24-hour clock and calendar. Time of day must be entered in 24 hour mode. For example, 6:00:00 PM = is indicated as 18:00:00.

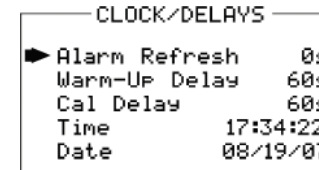

Figure 2-9. Clock/Delays Menu

2.3.3 COMM Port Remote ID Menu

The system Remote ID menu allows setting RTU address for the optional slave Modbus serial port (requires 10-0253 Modbus option PCB – see Section 3.2). This slave port may be used to transfer HA40 data to a host device such as a PC, PLC, DCS or even other Honeywell Analytics controllers, such as the 16 Channel HA71. The slave port is addressable, allowing many HA40 controllers to be connected to a single RS-485 cable. A converter is available to make this port also compatible with Ethernet TCP/IP networks.

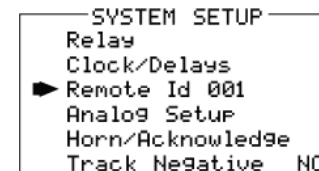

Figure 2-10. COMM Port ID Remote Menu

2.3.4 Analog Setup Menu

The system ANALOG SETUP menu allows setting the 12-bit A/D (analog to digital) counts and the 10-bit D/A (digital to analog) counts for each of the four channels. The live A/D counts value for the channel selected is also shown on the bottom of this screen.

The default setting for A/D counts is 800 for Min and 4000 for Max. This is based upon a 0-20mA input providing 0-4000 counts, or, 200 counts per mA input.

- A/D Min / Max Raw counts menu entries define the input counts value that cause Zero and Span readings as described in [Input Measurement Range](#). The default settings for each channel are 800 to 4000 counts because the HA40 4-20mA input PCB has a 12-bit analog to digital converter that yields 200 counts per milliamp input. Standard 4-20mA inputs yield 800 counts at 4mA and 4000 counts at 20mA. However, if a special application required the Zero reading at 6mA input and the Span reading at 18mA input the correct A/D Min / Max Raw counts menu entries would become 1200 to 3600.00.
- D/A Min / Max Raw counts menu options define the optional (future) 4-20mA output PCB's input. Ideally, 200 to 1000 yields a 4-20mA output but very slight modifications may be needed to provide precise 4mA and 20mA values for each channel.

ANALOG SETUP	
▶ Channel	1-4
A/D Min Raw	800
A/D Max Raw	4000
D/A Min Raw	200
D/A Max Raw	1000
A/D Counts	882

Figure 2-11. Analog Setup Menu

2.3.5 Horn / Acknowledge Menu

J2 on the motherboard (shown in [Figure 3.2](#)) is the driver output for part # 1000-1892 optional 100dB piezo. Fault, Alarm1, Alarm 2, & Alarm 3 menu options (shown in Figure 2-12) allow programming of which alarms affect this piezo and whether by pulse or steady tones. The HA40 display PCB is also equipped with a small audible piezo that chirps when keys are pressed, providing an audible feedback to the operator. It also may be set to audibly indicate alarm conditions by entering ON into the Local Piezo menu item in Figure 2-12. This piezo will then mimic the optional 100dB horn.

The Relay 2 ACK menu item determines if standard relay 2 may be acknowledged by an Alarm Reset. ON causes an Alarm Reset to silence the horn even though an alarm condition remains active.

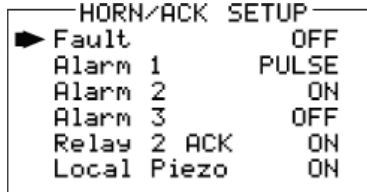

Figure 2-12. Horn/Acknowledge Menu

2.4 HA40 System Security Menu

A 4-digit Pass Code entered and confirmed in this menu item locks all menus. Viewing of menus is not denied but attempts to edit variables result in the “Locked” message on the LCD.

Authorized individuals locking the system should first enter a name, phone #, or other contact information into the 12 character field on the top line of the Security screen. To lock or unlock the system the correct 4 digit authorization number must be entered into the Pass Code field. It is very important to remember the 4 digit code since the factory must be consulted if it is lost.

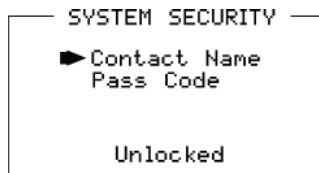

Figure 2-13. System Security Menu

3 Motherboard Interface PCB

3 Motherboard Interface PCB

(P/N 10-0215)

The HA40 Motherboard shown in Figure 3.2 is the interface between the Display / CPU assembly and all other system I/O devices. The Display / CPU assembly attaches to the motherboard with 4-standoffs and connects via ribbon cable to S1. Several input options, described in the following sections, are available that may be installed into the Sensor Input Option P1 connector located on the lower left side of the motherboard. The middle position P2 connector is for the 10-0223 4-20mA Output option and the right position P3 connector is for the 10-0222 Discrete Relay option. Other option devices such as Modbus RTU RS-485, Ethernet and a data logger may also be installed to connectors located on the Motherboard.

The Motherboard PCB contains a 24 VDC universal input (100-240 VAC) switching power supply with up to 350mA available at TB3 Auxiliary Power Output terminals (Figure 3.1). If AC power is unavailable, or if a DC battery back-up supply is needed, TB1 provides terminals for DC power input. Blocking diodes isolate internal and external DC supplies as shown in Figure 3-1.

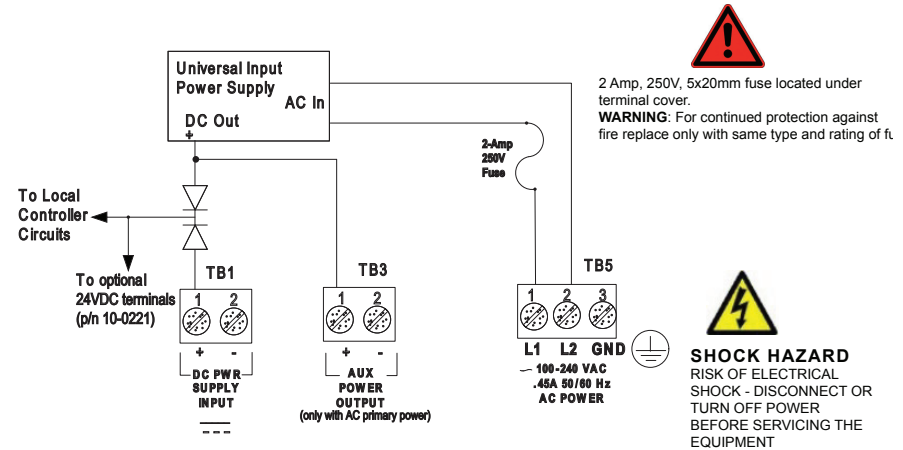

Figure 3-1. DC Power Supply Schematic

TB2 offers field terminals for a remote alarm reset switch. The motherboard also includes alarm relays 1 & 2 (K1 & K2) and their indicating LED's. TB4 provides field wiring terminals for these relays. TB5 is for connection to the 85-240 VAC power source. J2 is a 2-pin connector for powering the optional part # 1000-1892 audible annunciator.

3.1 Input / Output Optional PCB's

P1, P2 and P3 connectors on the motherboard offer unique positions for I/O options described in this section. A screen appears briefly after power up indicating what options types are connected.

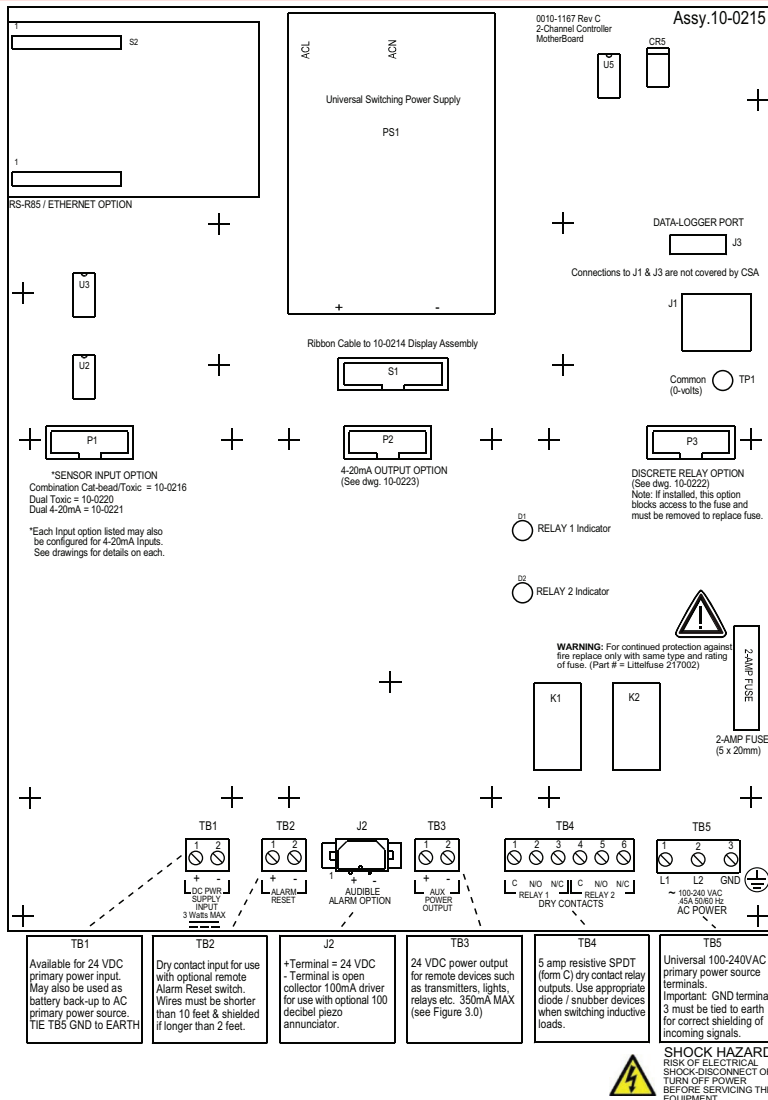

Figure 3-2. Motherboard Relays and Terminals

3.1.2 Optional Analog Input PCB (P/N 10-0221)

Transmitter input PCB option # 10-0298, shown in Figure 3-3, is available for interfacing the HA40 to field transmitters with 4-20mA or voltage outputs (0-2 VDC max). TB1 & TB2 provide Channel 24VDC, HI and LO terminals for receiving analog inputs. R1, R2, R3, & R4 are 100 ohm precision socketed termination resistors connected between each channel's HI & LO input terminals. These may be removed if voltage inputs are to be applied. Figure 3-4 shows correct wiring for both 2-wire and 3-wire transmitters.

TB3 provides the dedicated failsafe-5 amp-form C common FAULT relay.

- *R1 = Ch1 100 ohm 4-20mA terminator
- *R2 = Ch2 100 ohm 4-20mA terminator
- *R3 = Ch3 100 ohm 4-20mA terminator
- *R4 = Ch4 100 ohm 4-20mA terminator
- *Spare = Spare 100 ohm 4-20mA terminator

*These 5 resistors are socketed for easy replacement.

Terminators are connected between each channel's HI & LO terminals.

LO = 24VDC Power Supply Common
24VDC = 24VDC Power Supply + output

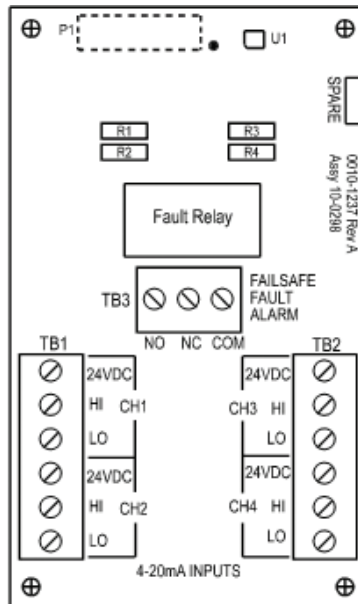

Figure 3-3. Optional Analog Input PCB (P/N 10-0221)

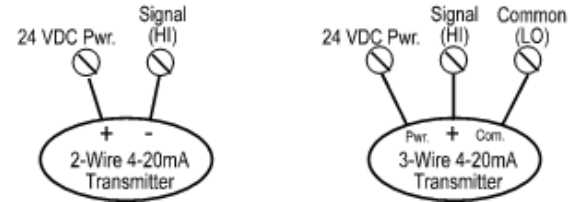

Figure 3-4. Wiring for 2- and 3-wire Transmitters

3.1.3 Optional Discrete Relay PCB's (P/N 10-0222)

The optional Discrete Relay PCB, shown in Figure 3-5, adds six 5 amp form C relays. Each relay is fully programmable as described in [Section 2.3.1](#). Many HA40 applications utilize the standard equipped Relay 1 / Relay 2 (see [Section 2.3.1](#)) and do not require optional discrete relays

WARNING

All mechanical (dry contact) relays are rated at 5 Amp for 28 VDC and 250 ~VAC RESISTIVE loads. IMPORTANT: Appropriate diode (DC loads) or MOV (AC loads) snubber devices must be installed with inductive loads to prevent RFI noise spikes.

AC or DC power supplies to relays on the 10-0222 Discrete Relay PCB option must be the same for each relay. Example: 24VDC should not be the power switched by one relay and 115VAC by others.

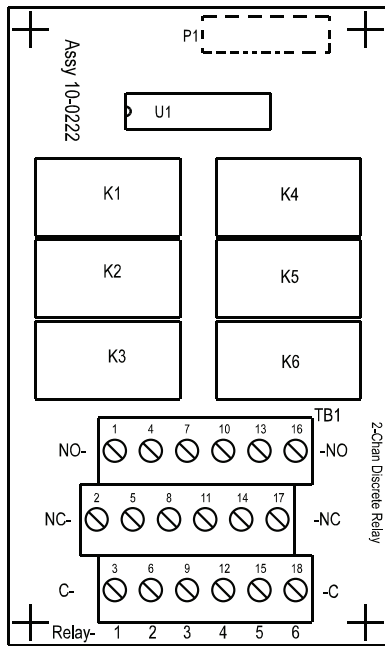

Note:
When installed, this option blocks access to the fuse and must be removed to replace a blown fuse.
WARNING: For continued protection against fire replace only with same type and rating of fuse.

K1, K2, K3, K4, K5 & K6 are programmable, as described in section 2.3.1
TB1 terminals 1,4,7,10,13 & 16 are Normally Open Contacts for K1-K6
TB1 terminals 2,5,8,11,14 & 17 are Normally Closed Contacts for K1-K6
TB1 terminals 3,6,9,12,15 & 18 are Common (pole) Contacts for K1-K6
Contacts are rated for 5 amp resistive loads. Arc suppressing snubber devices should be used for switching inductive loads.

Figure 3-5. Optional Discrete Relay PCB's (P/N 10-0222)

3.1.4 Optional 4-20mA Analog Output Board (P/N 10-0308)

An optional 4-20mA analog output board, shown in Figure 3-6, may be added. Each channel's output will transmit 4mA for 0% readings and 20mA for 100% readings. **Make certain that the mA loop output is set to LATCHING on reading devices connected to the HA40.**

If the HA40 primary power is 100 – 240 VAC, 4-20mA outputs are capable of driving 20mA through a 750 ohm load. Outputs are self powered and DC power should not be provided by the receiving device. Precision calibration of the 4-20mA output DAC (digital to analog converter) is accomplished via the Analog Setup menu as described in [Section 2.3.4](#).

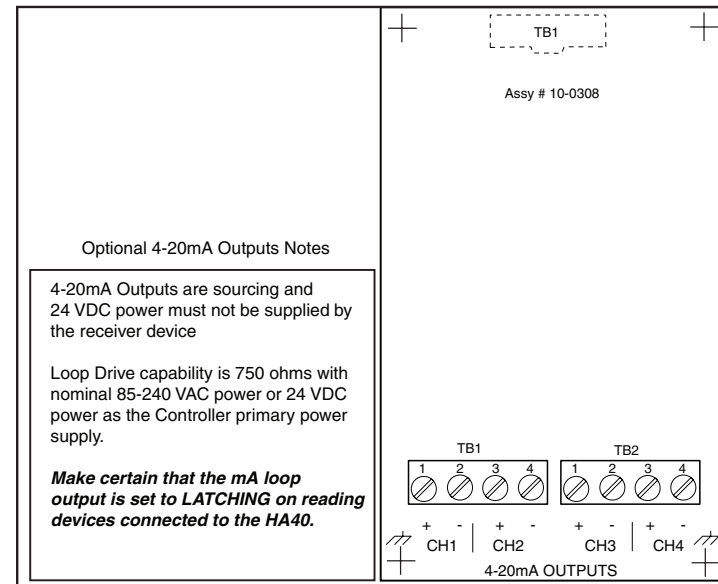

Figure 3-6. Optional 4-20mA Analog Output Board (P/N 10-0308)

3.2 MODBUS RS-232 / RS-485 Interface Option

(P/N 10-0253)

The 10-0253 Modbus option PCB add both RS-232 and RS-485 Modbus RTU slave ports. Figure 3-7 shows this optional PCB, which mounts to connectors on the upper right corner of the HA40 motherboard. TB1 provides two pairs of T/Rx terminals and a floating terminal for shield continuation. This makes it easy to multi-drop HA40s onto an RS-485 cable without doubling wires into the same screw terminals. RS-232 interface may be made by connecting to DB9 connector S1. [Section 3.3.1](#) lists all modbus registers and their function codes.



CAUTION

Follow correct IEEE RS-232 and RS-485 installation guidelines when using the 10-0253 option.

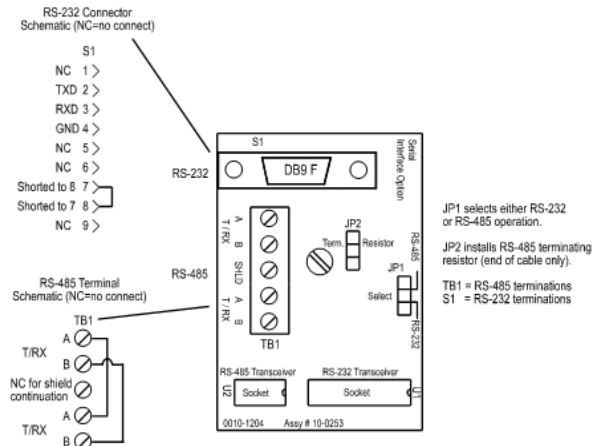

Figure 3-7. HA40 Modbus Interface Option (P/N 10-0253)

3.2.1 MODBUS Register And Function Code Summary

The following table identifies the available modbus RTU register locations and function codes.

VARIABLE	ALIAS	READ FUNCTION CODE	WRITE FUNCTION CODE
Read/Write Coils:			
Alarm Ack/Reset	2001	1	5
NOTE:			
After writing a TRUE to this register, the HA40 automatically returns it to FALSE.			
Read Only Discrete:			
Chan 1 Fault Alarm	12001	2	NA
Chan 1 Alarm 1	12002	2	NA
Chan 1 Alarm 2	12003	2	NA
Chan 1 Alarm 3	12004	2	NA
Chan 2 Fault Alarm	12005	2	NA
Chan 2 Alarm 1	12006	2	NA
Chan 2 Alarm 2	12007	2	NA
Chan 2 Alarm 3	12008	2	NA
Chan 3 Fault Alarm	12009	2	NA
Chan 3 Alarm 1	12010	2	NA
Chan 3 Alarm 2	12011	2	NA
Chan 3 Alarm 3	12012	2	NA
Chan 4 Fault Alarm	12013	2	NA
Chan 4 Alarm 1	12014	2	NA
Chan 4 Alarm 2	12015	2	NA
Chan 4 Alarm 3	12016	2	NA

Standard Relay 1	12017	2	NA
Standard Relay 2	12018	2	NA
Optional Relay 1	12019	2	NA
Optional Relay 2	12020	2	NA
Optional Relay 3	12021	2	NA
Optional Relay 4	12022	2	NA
Optional Relay 5	12023	2	NA
Optional Relay 6	12024	2	NA
Input Fault Relay	12025	2	NA

Read Only Registers:

Product ID	30001	4	NA
------------	-------	---	----

Returns the numeric value "1000" for product ID.

Firmware value	30002	4	NA
----------------	-------	---	----

Return a numeric value for firmware value as (Version X 100).

D2A Chan 1	31001	4	NA
------------	-------	---	----

D2A Chan 2	31002	4	NA
------------	-------	---	----

D2A Chan 3	31003	4	NA
------------	-------	---	----

D2A Chan 4	31004	4	NA
------------	-------	---	----

12 bit value representing the D2A value of 800 (0%) to 4000(100%) after all cal features are applied.

Chan 1 Status	31005	4	NA
---------------	-------	---	----

Chan 2 Status	31006	4	NA
---------------	-------	---	----

Chan 3 Status	31007	4	NA
---------------	-------	---	----

Chan 4 Status	31008	4	NA
---------------	-------	---	----

16 bit status word bit assignment for each channel.

	ALARM1_BELOW_BIT	BIT0
	ALARM2_BELOW_BIT	BIT1
	ALARM3_BELOW_BIT	BIT2
	ALARM1_LATCH_BIT	BIT3
	ALARM2_LATCH_BIT	BIT4
	ALARM3_LATCH_BIT	BIT5
	ALARM3_ACTIVE_BIT	BIT6
	CHANNEL_DISABLED_BIT	BIT7
	CHANNEL_CAL_BIT	BIT8

System Status Word	31009	4	NA
--------------------	-------	---	----

16 bit status word bit assignment for system status.

	PIEZO_DRIVE	BIT6
	HORN_ACK	BIT7
	K1_HORN_DRIVE	BIT8
	K2_HORN_DRIVE	BIT9
	K1_HORN_PULSE	BIT10
	K2_HORN_PULSE	BIT11
	K1_FAILSAFE	BIT12
	K2_FAILSAFE	BIT13
	K2_ACK	BIT14
	LOCK	BIT15

Alarm Status Word	31010	4	NA
-------------------	-------	---	----

16 bit status word bit assignment for system status.

CHAN1 FAULT	BIT0
CHAN1 ALARM1	BIT1
CHAN1 ALARM2	BIT2
CHAN1 ALARM3	BIT3
CHAN2 FAULT	BIT4
CHAN2 ALARM1	BIT5
CHAN2 ALARM2	BIT6
CHAN2 ALARM3	BIT7
CHAN3 FAULT	BIT8
CHAN3 ALARM1	BIT9
CHAN3 ALARM2	BIT10
CHAN3 ALARM3	BIT11
CHAN4 FAULT	BIT12
CHAN4 ALARM1	BIT13
CHAN4 ALARM2	BIT14
CHAN4 ALARM3	BIT15

LED Blink Status	31011	4	NA
Bit set to 1 = LED Blinking, bit set to 0 = LED is steady ON.			

CHAN1 FAULT	BIT0
CHAN1 ALARM1	BIT1
CHAN1 ALARM2	BIT2
CHAN1 ALARM3	BIT3
CHAN2 FAULT	BIT4
CHAN2 ALARM1	BIT5
CHAN2 ALARM2	BIT6
CHAN2 ALARM3	BIT7
CHAN3 FAULT	BIT8
CHAN3 ALARM1	BIT9
CHAN3 ALARM2	BIT10
CHAN3 ALARM3	BIT11
CHAN4 FAULT	BIT12
CHAN4 ALARM1	BIT13
CHAN4 ALARM2	BIT14
CHAN4 ALARM3	BIT15

Relay Status	31012	4	NA
Bit set to 1 = LED Blinking, bit set to 0 = LED is steady ON.			
	STANDARD RELAY 1		BIT0
	STANDARD RELAY 2		BIT1
	OPTION RELAY 1		BIT2
	OPTION RELAY 2		BIT3
	OPTION RELAY 3		BIT4
	OPTION RELAY 4		BIT5
	OPTION RELAY 5		BIT6
	OPTION RELAY 6		BIT7
	INPUT FAULT RELAY		BIT8
	Reserved		BIT9
	Reserved		BIT10
	Reserved		BIT11
	Reserved		BIT12
	Reserved		BIT13
	Reserved		BIT14
	Reserved		BIT15

VARIABLE	ALIAS	READ FUNCTION CODE	WRITE FUNCTION CODE
----------	-------	--------------------	---------------------

Memory Reals:

Notes: 41001 – 41040 “Real” represents float value without the decimal point such that 123.4 is returned as 1234. Decimal divisor is returned as 1, 10, 100, or 1000 for decimal position of 1, 2, 3, or 4, where 123.4 would return the divisor value 10.

Chan 1 Zero Real	41001	3	NA
Chan 1 Zero Divisor	41002	3	NA
Chan 1 Span Real	41003	3	NA
Chan 1 Span Divisor	41004	3	NA
Chan 1 Alarm 1 Real	41005	3	NA
Chan 1 Alarm 1 Divisor	41006	3	NA
Chan 1 Alarm 2 Real	41007	3	NA

Chan 1 Alarm 2 Divisor	41008	3	NA
Chan 1 Alarm 3 Real	41009	3	NA
Chan 1 Alarm 3 Divisor	41010	3	NA
Chan 2 Zero Real	41011	3	NA
Chan 2 Zero Divisor	41012	3	NA
Chan 2 Span Real	41013	3	NA
Chan 2 Span Divisor	41014	3	NA
Chan 2 Alarm 1 Real	41015	3	NA
Chan 2 Alarm 1 Divisor	41016	3	NA
Chan 2 Alarm 2 Real	41017	3	NA
Chan 2 Alarm 2 Divisor	41018	3	NA
Chan 2 Alarm 3 Real	41019	3	NA
Chan 2 Alarm 3 Divisor	41020	3	NA
Chan 3 Zero Real	41021	3	NA
Chan 3 Zero Divisor	41022	3	NA
Chan 3 Span Real	41023	3	NA
Chan 3 Span Divisor	41024	3	NA
Chan 3 Alarm 1 Real	41025	3	NA
Chan 3 Alarm 1 Divisor	41026	3	NA
Chan 3 Alarm 2 Real	41027	3	NA
Chan 3 Alarm 2 Divisor	41028	3	NA
Chan 3 Alarm 3 Real	41029	3	NA
Chan 3 Alarm 3 Divisor	41030	3	NA
Chan 4 Zero Real	41031	3	NA
Chan 4 Zero Divisor	41032	3	NA
Chan 4 Span Real	41033	3	NA
Chan 4 Span Divisor	41034	3	NA
Chan 4 Alarm 1 Real	41035	3	NA
Chan 4 Alarm 1 Divisor	41036	3	NA

Chan 4 Alarm 2 Real	41037	3	NA
Chan 4 Alarm 2 Divisor	41038	3	NA
Chan 4 Alarm 3 Real	41039	3	NA
Chan 4 Alarm 3 Divisor	41040	3	NA

Memory ASCII Strings:

User Info Chan 1	40401-40405	3	NA
User Info Chan 2	40406-40410	3	NA
User Info Chan 3	40411-40415	3	NA
User Info Chan 4	40416-40420	3	NA

10 ASCII characters (2 per register) assigned to the unit identifier read as bytes.

EUNITS Chan 1	40421-40425	3	NA
EUNITS Chan 2	40426-40430	3	NA
EUNITS Chan 3	40431-40435	3	NA
EUNITS Chan 4	40436-40440	3	NA

10 ASCII characters (2 per register) assigned to the engineering units read as bytes.

Chan 1 ASCII Reading	40441-40443	3	NA
Chan 2 ASCII Reading	40444-40446	3	NA
Chan 3 ASCII Reading	40447-40449	3	NA
Chan 4 ASCII Reading	40450-40452	3	NA

6 ASCII characters (2 per register) reflecting the display readout.

Firmware Version:

Version	40453-40455	3	NA
---------	-------------	---	----

4 ASCII characters (2 per register) reflecting the firmware version.

4 Enclosures

4 Enclosures

4.1 HA40N4 NEMA 4X Wall Mount Enclosure

The HA40-01 wall mount NEMA 4X enclosure is shown in Figure 4-1. Non-metallic enclosures are not grounded by metal conduit. For internal ground points to be grounded to earth, the TB5 – GND terminal must have a proper earth ground connection (see [Figure 3-2](#)).



Nonmetallic enclosure does not provide grounding between conduit connections. Use grounding type bushings and jumper wires. All field wiring must have insulation suitable for at least 250V.

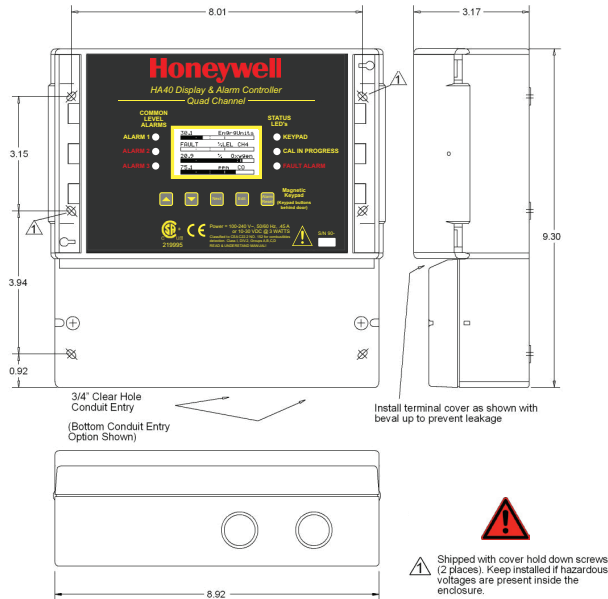

Figure 4-1. NEMA 4X Wall Mount Enclosure

4.2 HA40XP NEMA 7 Explosion-Proof Wall Mount Enclosure

The HA40XP shown in Figure 4.2 is an aluminum NEMA 7 wall mount enclosure designed for mounting into potentially hazardous.

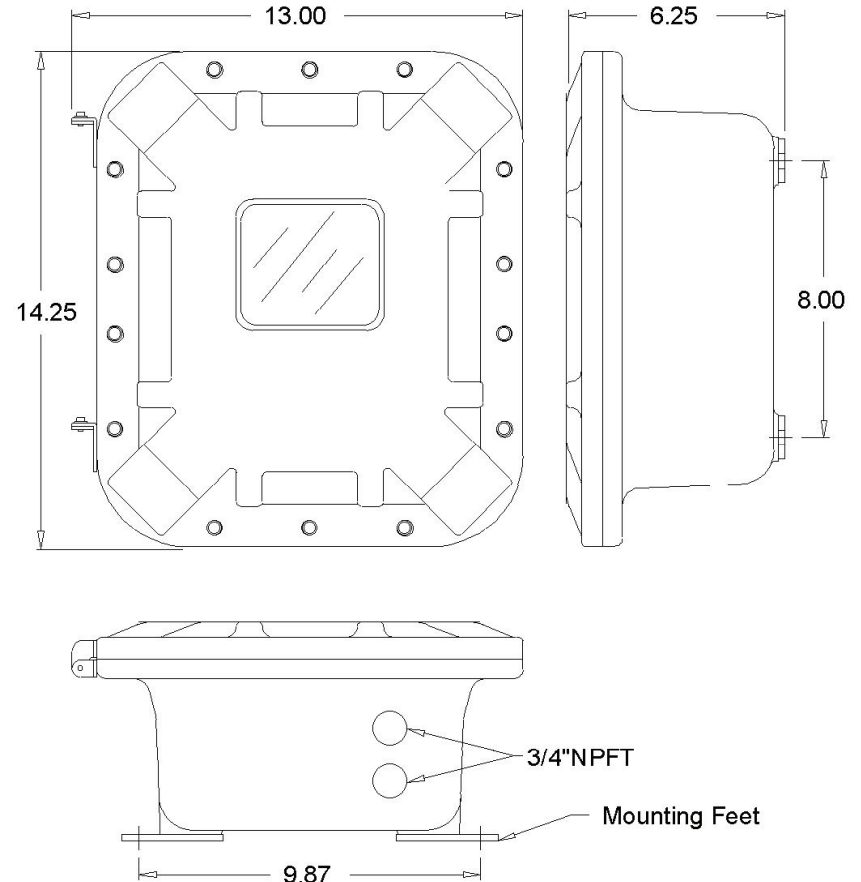

Figure 4-2. NEMA 7 Explosion-Proof Wall Mount Enclosure

5 Parts List

5 Parts List

Base Units

HA40N4	HA40 4 Channel in NEMA 4X Enclosure incl Magnetic Keypad for nonintrusive control, 4-20mA
HA40XP	HA40 4 Channel in NEMA 7 Enclosure incl Magnetic Keypad for nonintrusive control, 4-20mA

I/O Options

10-0221-4	Quad 4-20mA Analog Input PCB
-----------	------------------------------

Options and Accessories

10-0222	Relay Option to add six 5 amp Form C relays
10-0227	Modbus RS-232/RS-485 Option
10-0284	Division 2 red xenon strobe light (includes mounting to top of NEMA 4 models)
1000-1892	100db piezo audible (NEMA 4X enc. only)

6 Specifications

5 Specifications

Input power:	100-240 VAC, 50/60 Hz 24 VDC
DC output power:	15 watts (internal supply) 50 watts (optional external supply)
Relay output rating:	5A, 28 VDC or 250 VAC (resistive load)
Optional relay output rating	5A, 28 VDC or 250 VAC (resistive load)
Optional milliamp loop output	10 bit 4-20mA output. Maximum load 750 ohms with nominal 24 Vdc
Communication:	RS232 Modbus
Length of communication lines:	
Operating environment:	Industrial
Operating temperature range:	-25 to 50°C (-13°F to 122°F)
Operating humidity range:	0 to 90% RH non-condensing
Operating altitude:	2000m (6562 ft)
Audible alarm:	100 dB
Display:	128 x 64, backlight graphic LCD
Visual Indicators:	6 LED status indicators
Pollution degree:	N4: 3
Enclosure (N4):	NEMA 4X, Div. 2, Groups A,B,C,D, Category II
Enclosure (XP):	NEMA 7, Div. 1 & 2, Groups B,C,D
Dimensions (H x W x D):	N4: 10.32" x 8.92" x 3.17" (23.62 x 22.66 x 8.05cm) XP: 15.10" x 13" x 6.25" (36.2 x 33 x 15.88cm)
Weight:	N4: 2.27 Kg XP: 18.14 Kg

Certifications:	CSA C22.2 No. 1010-1, ISA S82.02 CSA C22.2 No 152 (for combustibles using mA input) UL 1604/C22.2 No. 213 (NEMA 4X = Div 2, Gr A, B, C, D; NEMA 7 = Div 1, Gr , B, C, D EN55011 & EN61000 (CE mark))
-----------------	---

7 Warranty |

Honeywell Analytics Warranty Statement

All products are designed and manufactured to the latest internationally recognized standards by Honeywell Analytics under a Quality Management System that is certified to ISO 9001.

As such, this instrument is warranted under proper use, to the original end-user purchaser, against any defects in materials or workmanship related failures for a period of 12 months from the date of first turn-on or 18 months from delivery from Honeywell Analytics to the customer, whichever is less. During this period, Honeywell Analytics will repair or replace defective parts on an exchange basis, F.O.B. to approved service centers on a global basis.

This warranty does not cover damage caused by accident, abuse, abnormal operating conditions or extreme poisoning of the sensor cartridge.

Defective equipment must be returned to Honeywell Analytics for repair. Before returning materials for repair or replacement, the Customer must obtain a Service Event Number (SE#) by contacting Honeywell Analytics Service in advance; include a detailed report stating the nature of the defect and ship the equipment prepaid to Honeywell Analytics' factory. If no detail report is included, Honeywell Analytics reserves the right to charge an investigative fee (prices available upon request) before any repair or replacement is performed. Returned goods must detail the Service Event Number (SE#) clearly on the package.

Service in the field or at the customer's premises is not covered under these warranty terms. Time and travel expenses for on-site warranty services will be charged at Honeywell Analytics' normal billing rates. Contact your Honeywell Analytics representative for information on available Service Contracts.

Honeywell Analytics shall not be liable for any loss or damage whatsoever or howsoever occasioned which may be a direct or indirect result of the use or operation of the Contract Goods by the Buyer or any Party.

This warranty covers the controller and parts sold to the Buyer only by authorized distributors, dealers and representatives as appointed by Honeywell Analytics. This warranty does not cover defects attributable to improper installation, repair by an unauthorized person or the use of unauthorized accessories/parts on the product. A warranty claim will only be accepted if a proof of purchase is submitted and all conditions obtained within this Warranty are met.

Honeywell Analytics reserves the right to validate any warranty claim prior to processing. Upon acceptance of a warranty claim, Honeywell Analytics will repair or replace the defective product free of charge. The initial warranty period is not extended by virtue of any works carried out there after.

Instruments which have been repaired or replaced during the warranty period are warranted for the remainder of the unexpired portion of the original warranty period. Honeywell Analytics is released from all obligations under its warranty in the event repairs or modifications are made by persons other than its own authorized personnel, unless such work is authorized in writing by Honeywell Analytics.

Honeywell Analytics reserves the right to change this policy at any time. Contact Honeywell Analytics for the most current warranty information.

Find out more

www.honeywellanalytics.com

**Customer business center
Americas**

Honeywell Analytics
404 Barclay Boulevard
Lincolnshire, IL 60069
Tel: +1 847 955 8200
Toll free: +1 800 538 0363
Fax: +1 847 955 8208
detectgas@honeywell.com

Europe, Middle East and Africa

Life Safety Distribution AG
Wilstrasse 11-U11
CH-8610 Uster
Switzerland
Tel: +41 (0)1 943 4300
Fax: +41 (0)1 943 4398
gasdetection@honeywell.com

Europe, Middle East and Africa

ha.global.service@honeywell.com

www.honeywell.com

Asia Pacific

Honeywell Analytics
#508, Kolon Science Valley (I)
187-10 Guro-Dong, Guro-Gu
Seoul, 152-050 Korea
Tel: +82 2 2025 0300
Fax: +82 2 2025 029

anapitics.ap@honeywell.com

Please Note:

While every effort has been made to ensure accuracy in this publication, no responsibility can be accepted for errors or omissions.

Data may change, as well as legislation, and you are strongly advised to obtain copies of the most recently issued regulations, standards and guidelines.

This publication is not intended to form the basis of a contract.

Honeywell